

**Stud Diode**

## Rectifier Diode

**SKN 45**

**SKR 45**

### Features

- Reverse voltages up to 1600 V
- Hermetic metal case with glass insulator
- Threaded stud ISO M8
- SKN: anode to stud, SKR: cathode to stud

### Typical Applications\*

- All-purpose mean power rectifier diodes
- Cooling via heatsinks
- Non-controllable and half-controllable rectifiers
- Free-wheeling diodes
- Recommended snubber network:  
 $RC: 0,1 \mu F, 100 \Omega (P_R = 1 W)$   
 $R_P = 80 k\Omega (P_R = 6 W)$

$V_{RSM}$ V	$V_{RRM}$ V	$I_{FRMS} = 80 A$ (maximum value for continuous operation)	
		$I_{FAV} = 45 A$ (sin. 180; $T_c = 125^\circ C$ )	
400	400	SKN 45/04	SKR 45/04
800	800	SKN 45/08	SKR 45/08
1200	1200	SKN 45/12	SKR 45/12
1400	1400	SKN 45/14	SKN 45/14
1600	1600	SKN 45/16	SKR 45/16

Symbol	Conditions	Values	Units
$I_{FAV}$	sin. 180; $T_c = 100^\circ C$	50	A
$I_D$	K 5; $T_a = 45^\circ C$ ; B2 / B6	40 / 57	A
	K 1,1; $T_a = 45^\circ C$ ; B2 / B6	86 / 120	A
$I_{FSM}$	$T_{vj} = 25^\circ C$ ; 10 ms	700	A
	$T_{vj} = 180^\circ C$ ; 10 ms	600	A
$i^2t$	$T_{vj} = 25^\circ C$ ; 8,3 ... 10 ms	2500	A <sup>2</sup> s
	$T_{vj} = 180^\circ C$ ; 8,3 ... 10 ms	1800	A <sup>2</sup> s
$V_F$	$T_{vj} = 25^\circ C$ ; $I_F = 150 A$	max. 1,6	V
$V_{(TO)}$	$T_{vj} = 180^\circ C$	max. 0,85	V
$r_T$	$T_{vj} = 180^\circ C$	max. 5	m $\Omega$
$I_{RD}$	$T_{vj} = 180^\circ C$ ; $V_{RD} = V_{RRM}$	max. 10	mA
$Q_{rr}$	$T_{vj} = 160^\circ C$ ; $- di_F/dt = 10 A/\mu s$	70	$\mu C$
$R_{th(j-c)}$		0,85	K/W
$R_{th(c-s)}$		0,25	K/W
$T_{vj}$		- 40 ... + 180	$^\circ C$
$T_{stg}$		- 55 ... + 180	$^\circ C$
$V_{isol}$		-	V~
$M_s$	to heatsink	4	Nm
a		5 * 9,81	m/s <sup>2</sup>
m	approx.	30	g
Case		E 12	

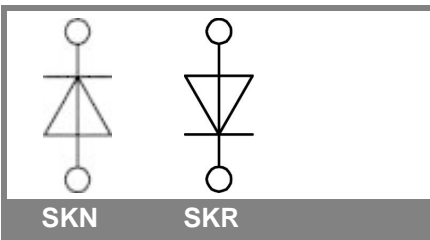

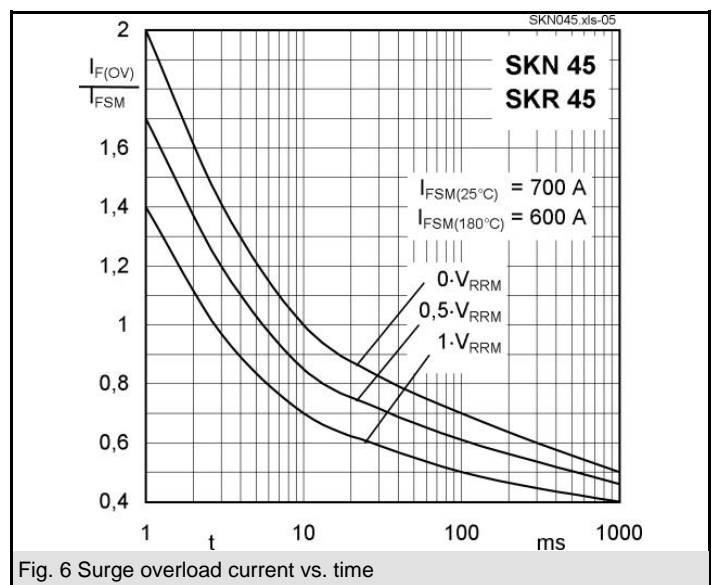
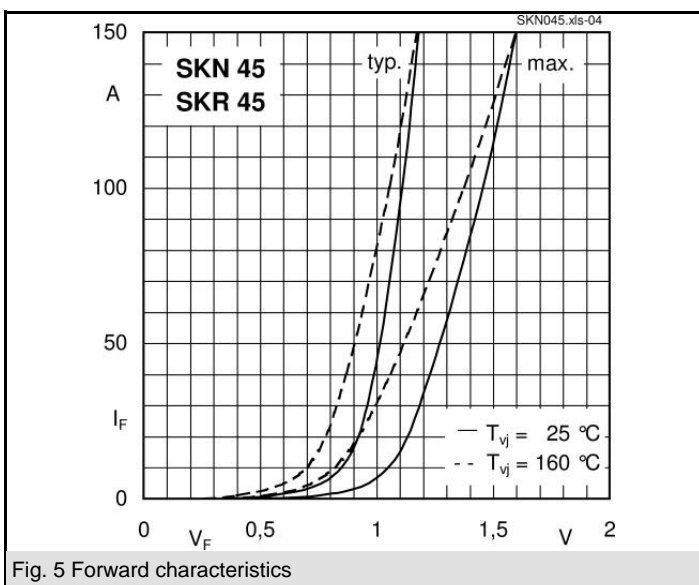
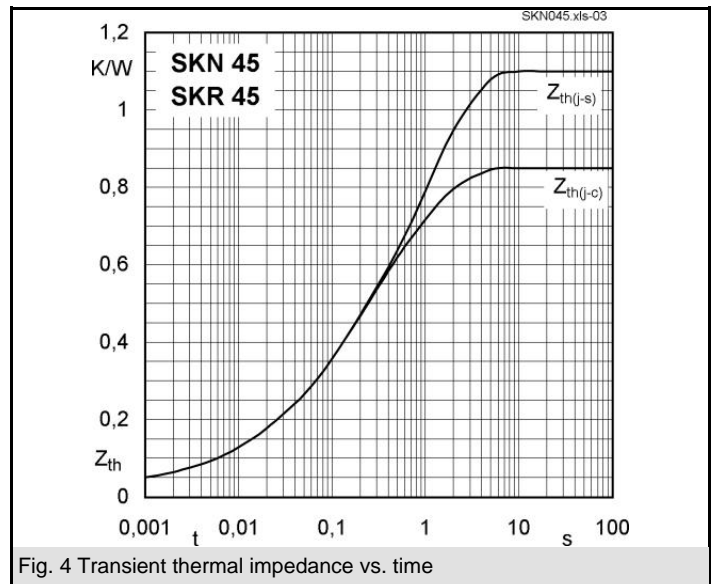
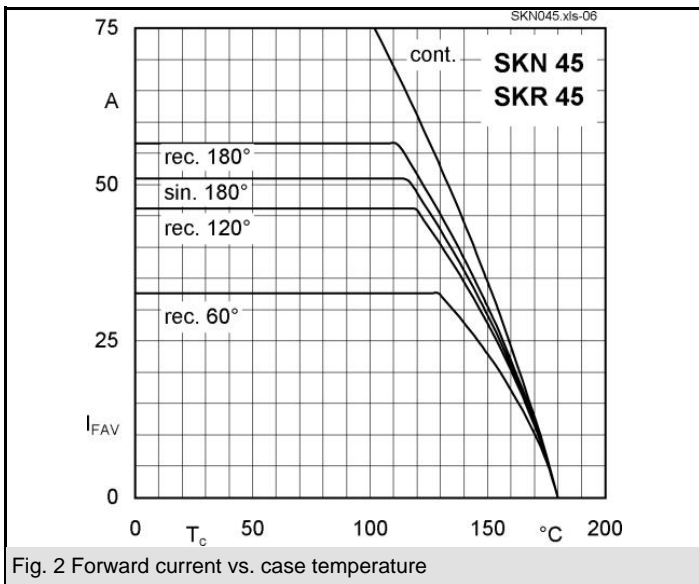
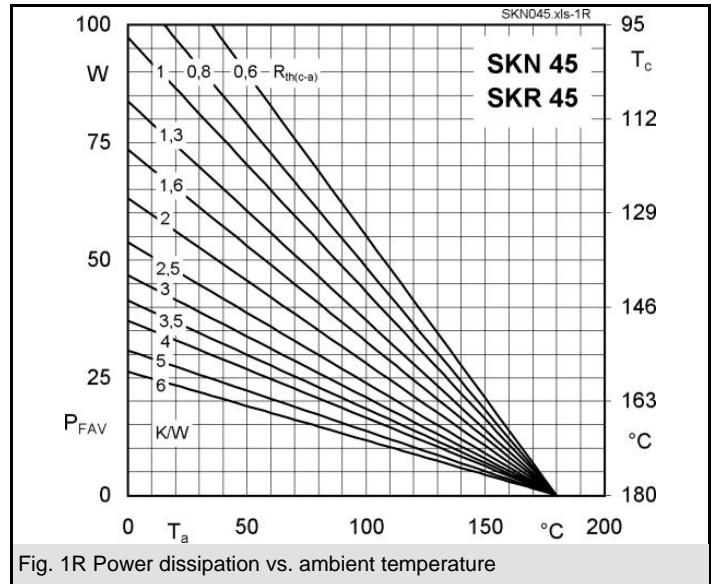
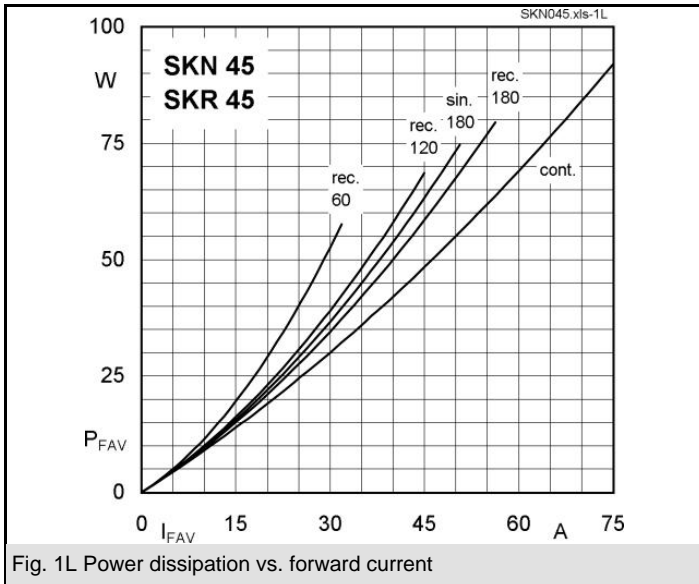

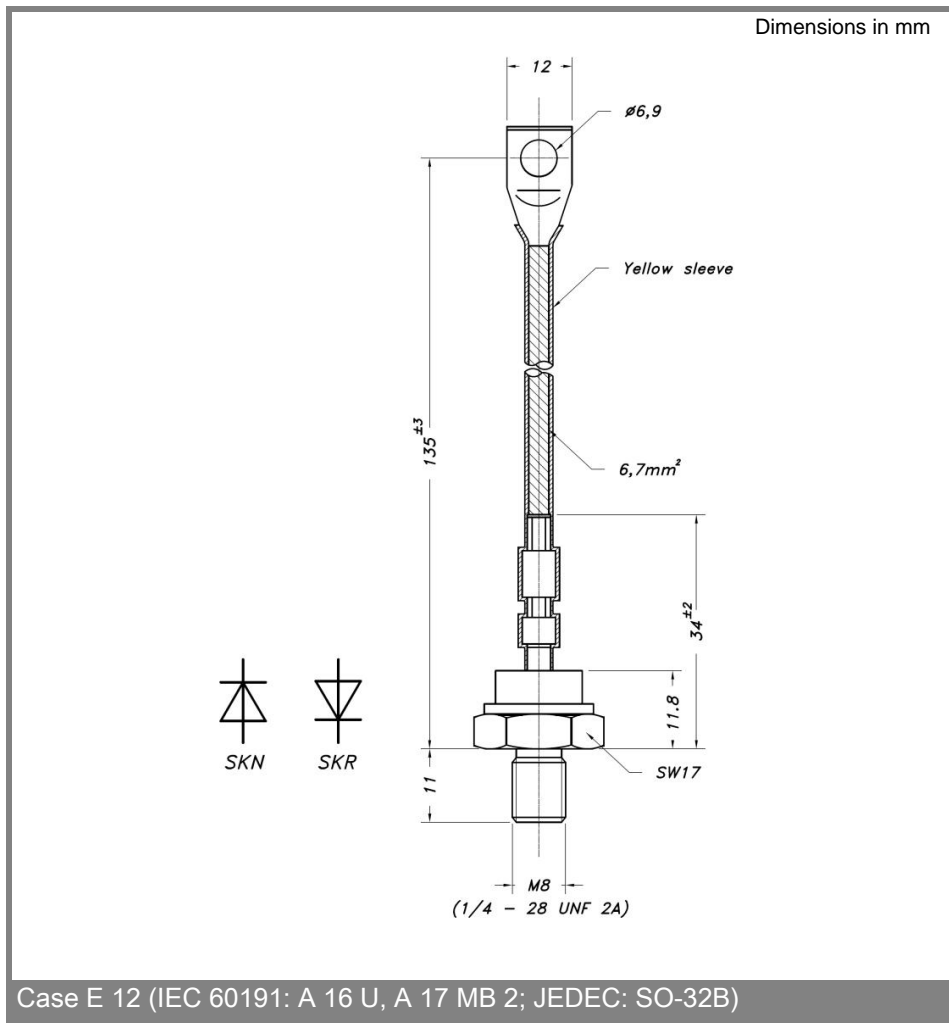

\* The specifications of our components may not be considered as an assurance of component characteristics. Components have to be tested for the respective application. Adjustments may be necessary. The use of SEMIKRON products in life support appliances and systems is subject to prior specification and written approval by SEMIKRON. We therefore strongly recommend prior consultation of our personal.