

# SKN 320



## Stud Diode

## Rectifier Diode

**SKN 320**

**SKR 320**

### Features

- Reverse voltages up to 1600 V
- Hermetic metal case with glass insulator
- Threaded stud ISO M24 x 1,5
- SKN: anode to stud,  
SKR: cathode to stud

### Typical Applications\*

- All-purpose high power rectifier diodes
- Cooling via heatsinks
- Non-controllable and half-controllable rectifiers
- Free-wheeling diodes
- Recommended snubber network:  
RC: 1  $\mu$ F, 20  $\Omega$  ( $P_R = 2$  W),  
 $R_p = 25$  k $\Omega$  ( $P_R = 20$  W)

$V_{RSM}$ V	$V_{RRM}$ V	$I_{FRMS} = 700$ A (maximum value for continuous operation) $I_{FAV} = 320$ A (sin. 180; $T_c = 125$ °C)	
400	400	SKN 320/04	SKR 320/04
800	800	SKN 320/08	SKR 320/08
1200	1200	SKN 320/12	SKR 320/12
1400	1400	SKN 320/14	SKR 320/14
1600	1600	SKN 320/16	SKR 320/16

Symbol	Conditions	Values	Units
$I_{FAV}$	sin. 180; $T_c = 85$ (100) °C	445 (420)	A
$I_D$	P 1/200; $T_a = 45$ °C; B2 / B6	480 / 690	A
	K 0,55F; $T_a = 35$ °C; B2 / B6	760 / 1080	A
$I_{FSM}$	$T_{vj} = 25$ °C; 10 ms	9000	A
	$T_{vj} = 180$ °C; 10 ms	8000	A
$i^2t$	$T_{vj} = 25$ °C; 8,3 ... 10 ms	400000	A <sup>2</sup> s
	$T_{vj} = 180$ °C; 8,3 ... 10 ms	300000	A <sup>2</sup> s
$V_F$	$T_{vj} = 25$ °C; $I_F = 1000$ A	max. 1,35	V
$V_{(TO)}$	$T_{vj} = 180$ °C	max. 0,8	V
$r_T$	$T_{vj} = 180$ °C	max. 0,45	m $\Omega$
$I_{RD}$	$T_{vj} = 180$ °C; $V_{RD} = V_{RRM}$	max. 100	mA
$Q_{rr}$	$T_{vj} = 160$ °C; $- di_F/dt = 10$ A/ $\mu$ s	300	$\mu$ C
$R_{th(j-c)}$		0,16	K/W
$R_{th(c-s)}$		0,015	K/W
$T_{vj}$		- 40 ... + 180	°C
$T_{stg}$		- 55 ... + 180	°C
$V_{isol}$		-	V~
$M_s$	to heatsink	60	Nm
a		5 * 9,81	m/s <sup>2</sup>
m	approx.	500	g
Case		E 16	

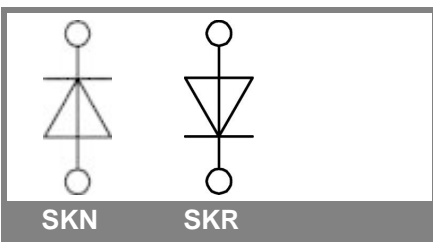

SKN

SKR

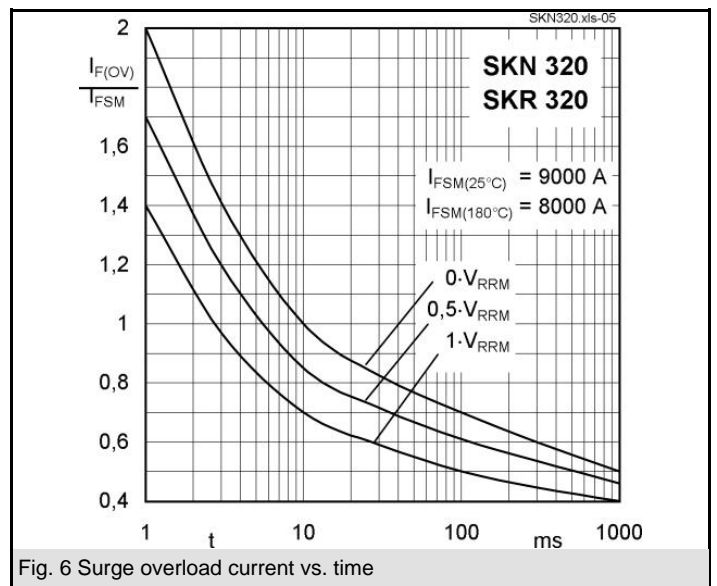
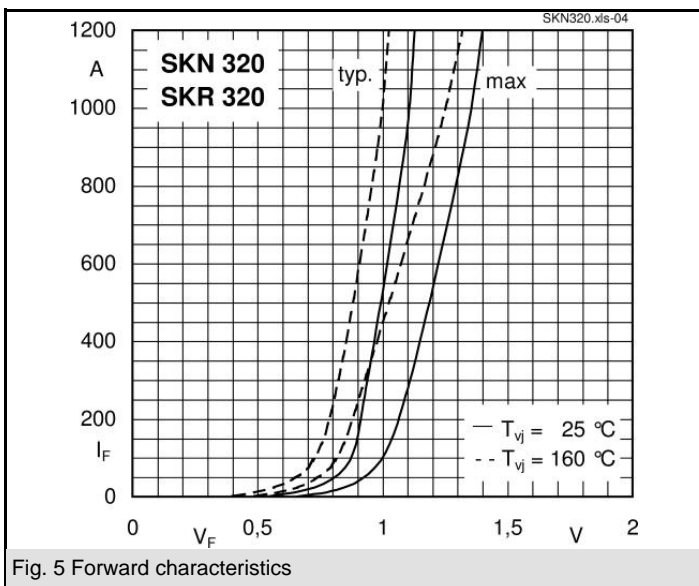
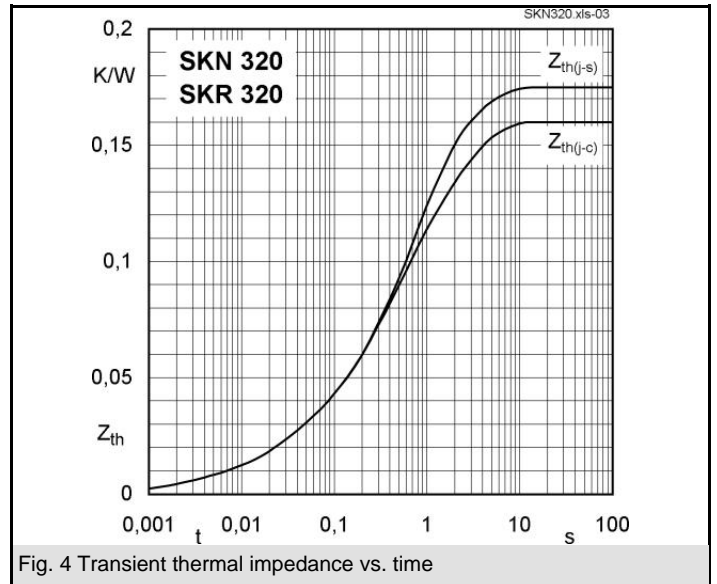
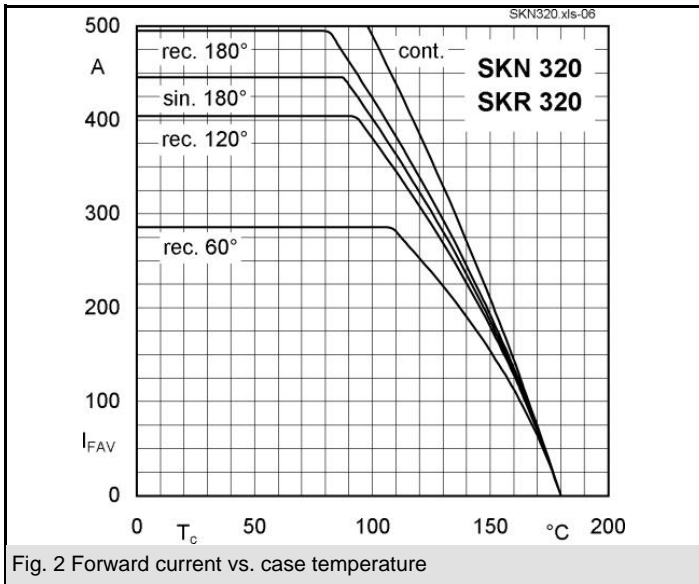
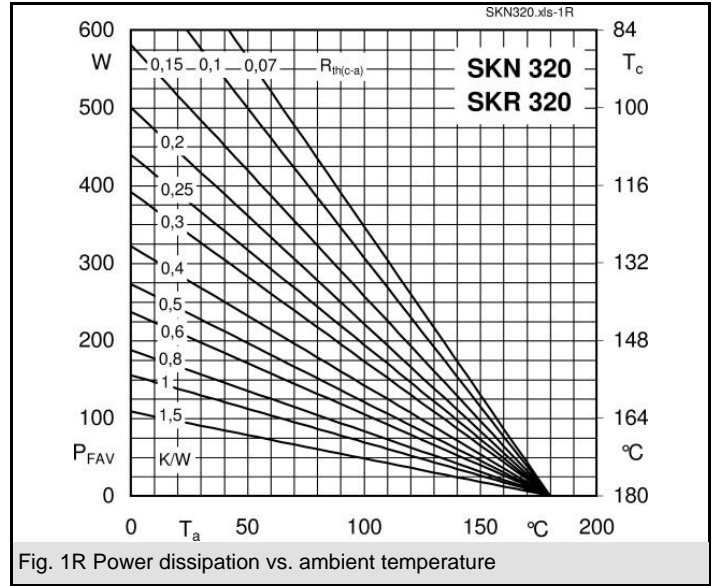
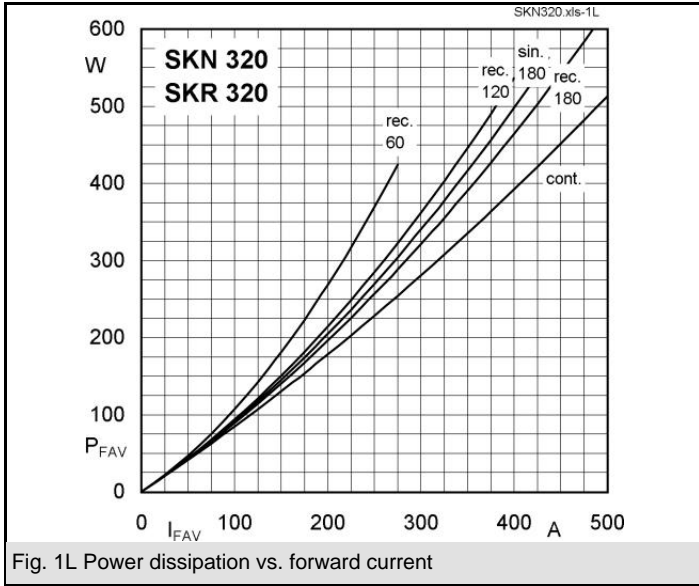

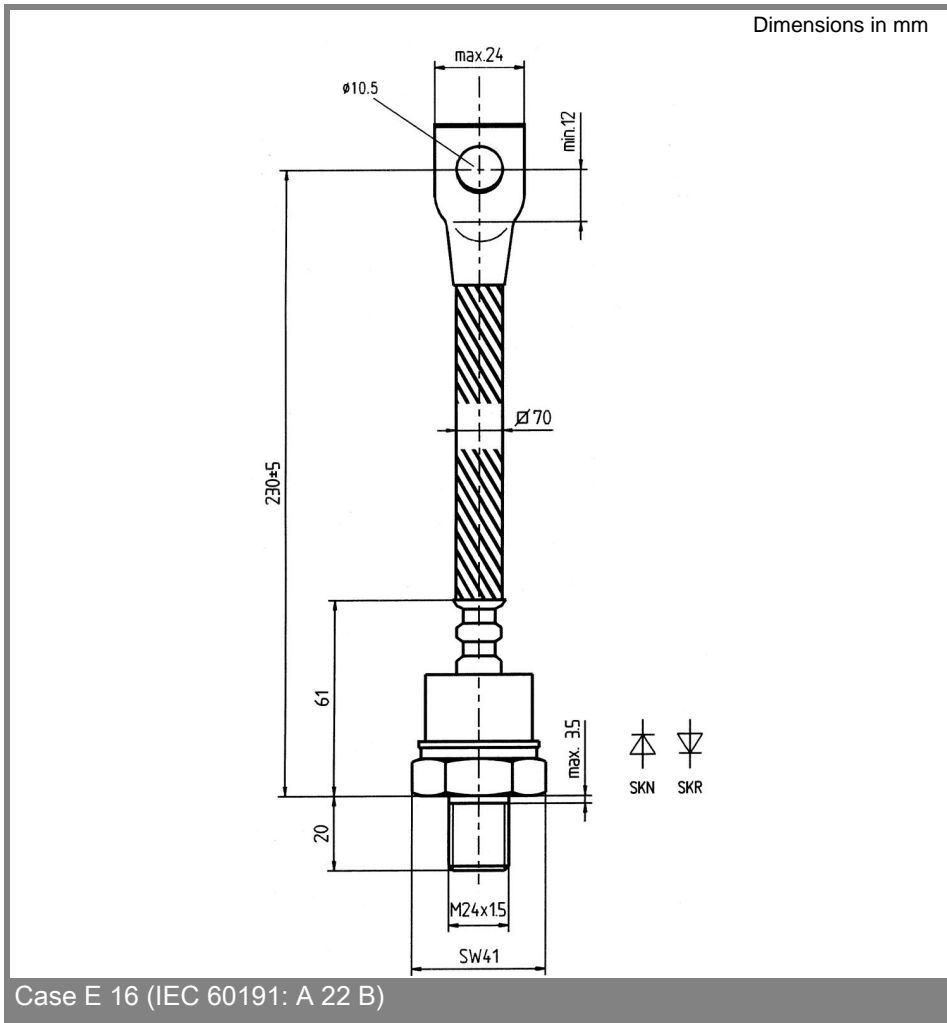

\* The specifications of our components may not be considered as an assurance of component characteristics. Components have to be tested for the respective application. Adjustments may be necessary. The use of SEMIKRON products in life support appliances and systems is subject to prior specification and written approval by SEMIKRON. We therefore strongly recommend prior consultation of our personal.