

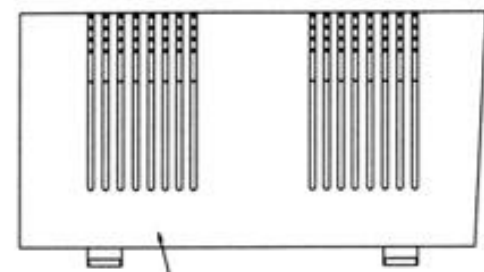

DETALHE DO FECHAMENTO AUTO-TRAVANTE
EM CORTE ESCALA 3x



PERSPECTIVA DE



GARRAS PARA TRAVA

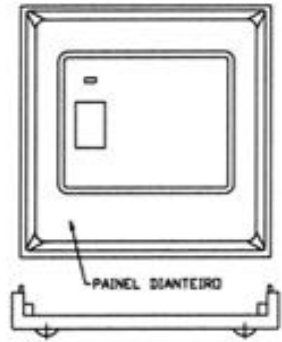

PAINEL DIANTEIRO

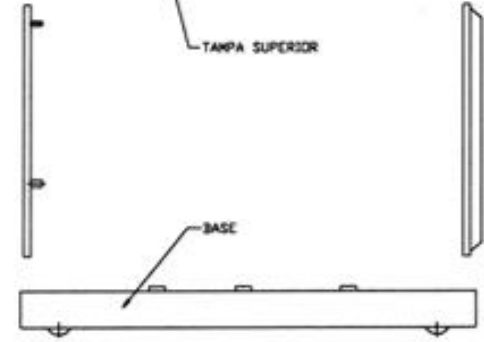

TAMPA SUPERIOR

BASE

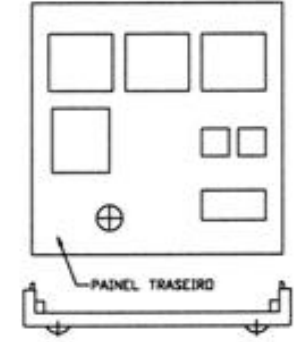

PAINEL TRASEIRO

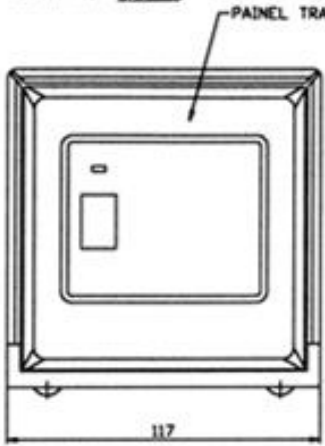

PAINEL TRASEIRO

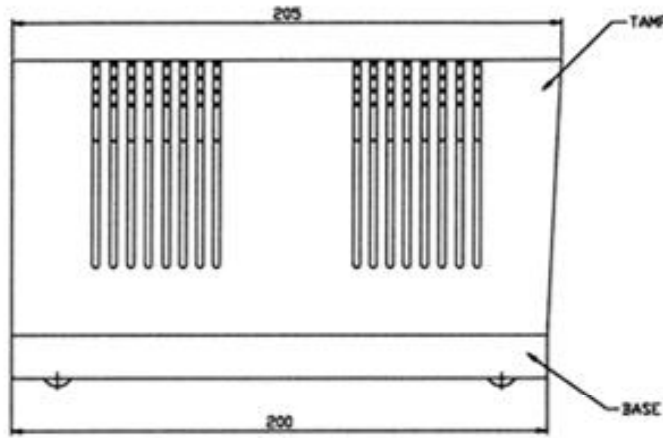

TAMPA SUPERIOR

PAINEL TRASEIRO

BASE

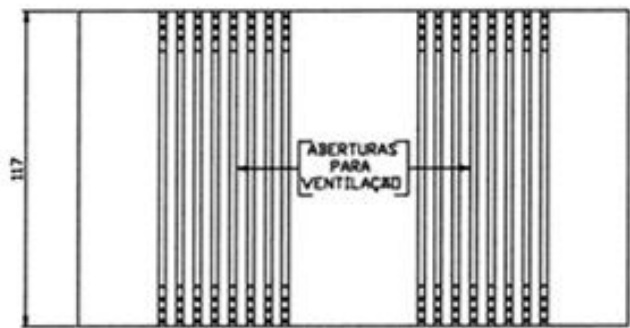
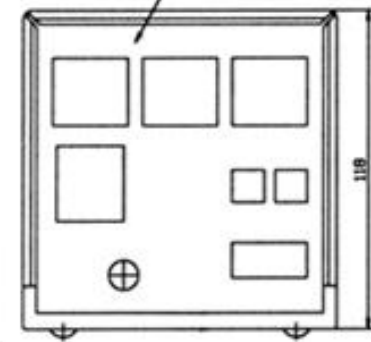

ABERTURAS PARA VENTILAÇÃO

