

Guard Lock Safety-door Switch D4GL

Environment-friendly Switch with Direct Opening Contacts

- Contains no harmful substances, such as lead, cadmium or hexavalent chromium, reducing the burden on the environment.
- Slim safety-door switch with an electromagnetic lock or unlock mechanism.
- Models with 4-contact and 5-contact built-in Switches are available.
- A key holding force of 1,000 N minimum.
- Can be used for either standard loads or microloads.
- Lineup includes models with a conduit size of M20.

Note: Be sure to read the "Safety Precautions" on page A-47 and the "Precautions for All Safety Door Switches" on page A-2.



Safety Door
Switches
D4GL

Model Number Structure

Model Number Legend

Switch

D4GL-□□□□-□□
1 2 3 4 5 6

1. Conduit Size

- 1: Pg13.5
- 2: G1/2
- 4: M20

2. Built-in Switch (with Door Open/Closed Detection Switch and Lock Monitor Switch Contacts)

- A: 1NC/1NO slow-action contacts plus 1NC/1NO slow-action contacts
- B: 1NC/1NO slow-action contacts plus 2NC slow-action contacts
- C: 2NC slow-action contacts plus 1NC/1NO slow-action contacts
- D: 2NC slow-action contacts plus 2NC slow-action contacts
- E: 2NC/1NO slow-action contacts plus 1NC/1NO slow-action contacts
- F: 2NC/1NO slow-action contacts plus 2NC slow-action contacts
- G: 3NC slow-action contacts plus 1NC/1NO slow-action contacts
- H: 3NC slow-action contacts plus 2NC slow-action contacts

3. Head Mounting Direction and Material

- F: Four mounting directions possible (Front-side mounting at time of delivery)/plastic

4. Door Lock and Release

- A: Mechanical lock/24-VDC solenoid release
- G: 24-VDC solenoid lock/mechanical release

5. Indicator

- B: 24 VDC (orange/green LED indicator)

6. Release Key Type

- Blank: Standard release key
- 4: Special release key

Operation Key

D4DS-K□
1

1. Operation Key Type

- 1: Horizontal mounting
- 2: Vertical mounting
- 3: Adjustable mounting (horizontal)
- 5: Adjustable mounting (horizontal/vertical)

Ordering Information

■ List of Models

Switches (Operation Keys are sold separately.)



Safety Door Switches
D4GL

Head material	Release key type	Solenoid voltage/ indicator	Lock and release types	Contact configuration (door open/closed detection switch and lock monitor switch contacts) (slow-action) Approved direct opening NC contact	Conduit size	Model
Plastic	Standard	Solenoid: 24 VDC Orange/green LED: 24 VDC	Mechanical lock Solenoid release	1NC/1NO+1NC/1NO	Pg13.5	D4GL-1AFA-A
					G1/2	D4GL-2AFA-A
					M20	D4GL-4AFA-A
				1NC/1NO+2NC	Pg13.5	D4GL-1BF A-A
					G1/2	D4GL-2BF A-A
					M20	D4GL-4BF A-A
				2NC+1NC/1NO	Pg13.5	D4GL-1CF A-A
					G1/2	D4GL-2CF A-A
					M20	D4GL-4CF A-A
				2NC+2NC	Pg13.5	D4GL-1DF A-A
					G1/2	D4GL-2DF A-A
					M20	D4GL-4DF A-A
				2NC/1NO+1NC/1NO	Pg13.5	D4GL-1EF A-A
					G1/2	D4GL-2EF A-A
					M20	D4GL-4EF A-A
				2NC/1NO+2NC	Pg13.5	D4GL-1FF A-A
					G1/2	D4GL-2FF A-A
					M20	D4GL-4FF A-A
				3NC+1NC/1NO	Pg13.5	D4GL-1GF A-A
					G1/2	D4GL-2GF A-A
					M20	D4GL-4GF A-A
				3NC+2NC	Pg13.5	D4GL-1HF A-A
					G1/2	D4GL-2HF A-A
					M20	D4GL-4HF A-A
			Solenoid lock Mechanical release	1NC/1NO+1NC/1NO	Pg13.5	D4GL-1AFG-A
					G1/2	D4GL-2AFG-A
					M20	D4GL-4AFG-A
				1NC/1NO+2NC	Pg13.5	D4GL-1BFG-A
					G1/2	D4GL-2BFG-A
					M20	D4GL-4BFG-A
				2NC+1NC/1NO	Pg13.5	D4GL-1CFG-A
					G1/2	D4GL-2CFG-A
					M20	D4GL-4CFG-A
				2NC+2NC	Pg13.5	D4GL-1DFG-A
					G1/2	D4GL-2DFG-A
					M20	D4GL-4DFG-A
				2NC/1NO+1NC/1NO	Pg13.5	D4GL-1EFG-A
					G1/2	D4GL-2EFG-A
					M20	D4GL-4EFG-A
				2NC/1NO+2NC	Pg13.5	D4GL-1FFG-A
					G1/2	D4GL-2FFG-A
					M20	D4GL-4FFG-A
				3NC+1NC/1NO	Pg13.5	D4GL-1GFG-A
					G1/2	D4GL-2GFG-A
					M20	D4GL-4GFG-A
				3NC+2NC	Pg13.5	D4GL-1HFG-A
					G1/2	D4GL-2HFG-A
					M20	D4GL-4HFG-A

Head material	Release key type	Solenoid voltage/indicator	Lock and release types	Contact configuration (door open/closed detection switch and lock monitor switch contacts) (slow-action) Approved direct opening NC contact	Conduit size	Model
Plastic	Special release key	Solenoid: 24 VDC Orange/green LED: 24 VDC	Mechanical lock Solenoid release	1NC/1NO+1NC/1NO	Pg13.5	D4GL-1AFA-A4
					G1/2	D4GL-2AFA-A4
					M20	D4GL-4AFA-A4
				1NC/1NO+2NC	Pg13.5	D4GL-1BFA-A4
					G1/2	D4GL-2BFA-A4
					M20	D4GL-4BFA-A4
				2NC+1NC/1NO	Pg13.5	D4GL-1CFA-A4
					G1/2	D4GL-2CFA-A4
					M20	D4GL-4CFA-A4
				2NC+2NC	Pg13.5	D4GL-1DFA-A4
					G1/2	D4GL-2DFA-A4
					M20	D4GL-4DFA-A4
				2NC/1NO+1NC/1NO	Pg13.5	D4GL-1EFA-A4
					G1/2	D4GL-2EFA-A4
					M20	D4GL-4EFA-A4
				2NC/1NO+2NC	Pg13.5	D4GL-1FFA-A4
					G1/2	D4GL-2FFA-A4
					M20	D4GL-4FFA-A4
				3NC+1NC/1NO	Pg13.5	D4GL-1GFA-A4
					G1/2	D4GL-2GFA-A4
					M20	D4GL-4GFA-A4
				3NC+2NC	Pg13.5	D4GL-1HFA-A4
					G1/2	D4GL-2HFA-A4
					M20	D4GL-4HFA-A4
			Solenoid lock Mechanical release	1NC/1NO+1NC/1NO	Pg13.5	D4GL-1AFG-A4
					G1/2	D4GL-2AFG-A4
					M20	D4GL-4AFG-A4
				1NC/1NO+2NC	Pg13.5	D4GL-1BFG-A4
					G1/2	D4GL-2BFG-A4
					M20	D4GL-4BFG-A4
				2NC+1NC/1NO	Pg13.5	D4GL-1CFG-A4
					G1/2	D4GL-2CFG-A4
					M20	D4GL-4CFG-A4
				2NC+2NC	Pg13.5	D4GL-1DFG-A4
					G1/2	D4GL-2DFG-A4
					M20	D4GL-4DFG-A4
				2NC/1NO+1NC/1NO	Pg13.5	D4GL-1EFG-A4
					G1/2	D4GL-2EFG-A4
					M20	D4GL-4EFG-A4
				2NC/1NO+2NC	Pg13.5	D4GL-1FFG-A4
					G1/2	D4GL-2FFG-A4
					M20	D4GL-4FFG-A4
				3NC+1NC/1NO	Pg13.5	D4GL-1GFG-A4
					G1/2	D4GL-2GFG-A4
					M20	D4GL-4GFG-A4
				3NC+2NC	Pg13.5	D4GL-1HFG-A4
					G1/2	D4GL-2HFG-A4
					M20	D4GL-4HFG-A4

Safety Door Switches
D4GL

Operation Keys (Order Separately)

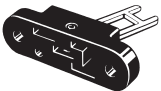
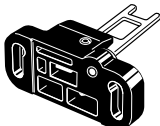
Type	Model
Horizontal mounting 	D4DS-K1
Vertical mounting 	D4DS-K2
Adjustable mounting (Horizontal) 	D4DS-K3
Adjustable mounting (Horizontal/Vertical) 	D4DS-K5

Safety Door Switches

D4GL

Specifications

■ Standards and EC Directives

- Machinery Directive
- Low Voltage Directive
- EN1088
- EN60204-1
- GS-ET-19

■ Approved Standard Ratings

TÜV (EN60947-5-1), CCC (GB14048.5)

Item	Utilization category	AC-15	DC-13
Rated operating current (I _e)		0.75 A	0.27 A
Rated operating voltage (U _e)		240 V	250 V

Note: Use a 10-A fuse type gI or gG that conforms to IEC60269 as a short-circuit protection device.

UL/CSA (UL508, CSA C22.2 No. 14)

C300

Rated voltage	Carry current	Current		Volt-amperes	
		Make	Break	Make	Break
120 VAC	2.5 A	15 A	1.5 A	1,800 VA	180 VA
240 VAC		7.5 A	0.75 A		

■ Approved Standards

Agency	Standard	File No.
TÜV Product Service	EN60947-5-1 (approved direct opening)	(See note 1.)
UL (See note 2.)	UL508, CSA C22.2 No.14	E76675
CQC (CCC)	GB14048.5	2003010305064 264

- Note:**
1. Consult your OMRON representative for details.
 2. Approval for CSA C22.2 No. 14 is authorized by the UL mark.
 3. Ask your OMRON representative for information on approved models.

Q300

Rated voltage	Carry current	Current		Volt-amperes	
		Make	Break	Make	Break
125 VAC	2.5 A	0.55 A	0.55 A	69 VA	69 VA
250 VAC		0.27 A	0.27 A		

Solenoid Coil Characteristics

Item	24 VDC
Rated operating voltage (100% ED)	24 VDC ±10%
Current consumption	Approx. 200 mA
Insulation	Class F (130°C max.)

Indicator Characteristics

Item	LED
Rated voltage	24 VDC
Current leakage	Approx. 3 mA
Color (LED)	Orange/Green

■ Characteristics

Degree of protection (See note 3.)		IP67 (EN60947-5-1) (This applies for the Switch only. The degree of protection for the key hole is IP00.)	
Durability (See note 4.)	Mechanical	1,000,000 operations min.	
	Electrical	500,000 operations min. for a resistive load of 4 mA at 24 VDC; 150,000 operations min. for a resistive load of 1 A at 125 VAC in 2 circuits and 4 mA at 24 VDC in 2 circuits (See note 5.)	
Operating speed		0.05 to 0.5 m/s	
Operating frequency		30 operations/minute max.	
Rated frequency		50/60 Hz	
Contact gap		2 x 2 mm min.	
Direct opening force (See note 6.)		60 N min. (EN60947-5-1)	
Direct opening travel (See note 6.)		10 mm min. (EN60947-5-1)	
Holding force (See note 7.)		1,000 N min.	
Insulation resistance		100 MΩ min. (at 500 VDC)	
Minimum applicable load (See note 8.)		Resistive load of 4 mA at 24 VDC (N-level reference value)	
Rated insulation voltage (U_i)		300 V (EN60947-5-1)	
Conventional enclosed thermal current (I_{the})		2.5 A (EN60947-5-1)	
Impulse withstand voltage (EN60947-5-1)		Between terminals of the same polarity	2.5 kV
		Between terminals of different polarities	4 kV
		Between solenoid and uncharged metallic parts	0.8 kV
		Between other terminals and uncharged metallic parts and between other terminals and ground	4 kV
Conditional short-circuit current		100 A (EN60947-5-1)	
Pollution degree (operating environment)		3 (EN60947-5-1)	
Protection against electric shock		Class II (double insulation)	
Closed-circuit counterelectromotive force		1,500 V max. (EN60947-5-1)	
Contact resistance		100 mΩ max. (initial value)	
Vibration resistance	Malfunction	10 to 55 Hz, 0.75-mm single amplitude	
	Destruction	1,000 m/s ² min.	
Shock resistance	Malfunction	300 m/s ² min.	
	Destruction	1,000 m/s ² min.	
Ambient temperature		Operating: -10°C to 55°C with no icing	
Ambient humidity		Operating: 95% max.	
Weight		Approx. 400 g (D4GL-1AFA-A)	

Note: 1. The above values are initial values.

- The Switch contacts can be used with either standard loads or microloads. Once the contacts have been used to switch a load, however, they cannot be used to switch smaller loads. The contact surfaces will become rough once they have been used and contact reliability for smaller loads may be reduced.
- The degree of protection is tested using the method specified by the standard (EN60947-5-1). Confirm that sealing properties are sufficient for the operating conditions and environment beforehand. Although the switch box is protected from dust or water penetration, do not use the D4GL in places where foreign material may enter through the key hole on the head, otherwise Switch damage or malfunctioning may occur.
- The durability is for an ambient temperature of 5°C to 35°C and an ambient humidity of 40% to 70%. For more details, consult your OMRON representative.
- If the ambient temperature is greater than 35°C, do not pass the 1-A, 125-VAC load through more than 2 circuits.
- These figures are minimum requirements for safe operation.
- This figure is based on the GS-ET-19 evaluation method.
- This value will vary with the switching frequency, environment, and reliability level. Confirm that correct operation is possible with the actual load beforehand.

Connections

Contact Form

Indicates conditions where the Key is inserted and the lock is applied. Terminals 12 and 41 are connected internally (as per BIA GS-ET-19).

Model	Contact	Contact form (door open/closed detection switch and lock monitor switch contacts)	Operating pattern	Remarks
D4GL-□AF□-□	1NC/1NO + 1NC/1NO			Only NC contact 11-12 has an approved direct opening mechanism. (→) The terminals 11-42, 33-34, and 53-54 can be used as unlike poles.
D4GL-□BF□-□	1NC/1NO + 2NC			Only NC contact 11-12, has an approved direct opening mechanism. (→) The terminals 11-42, 33-34, and 51-52 can be used as unlike poles.
D4GL-□CF□-□	2NC + 1NC/1NO			Only NC contacts 11-12 and 21-22 have an approved direct opening mechanism. (→) The terminals 11-42, 21-22, and 53-54 can be used as unlike poles.
D4GL-□DF□-□	2NC + 2NC			Only NC contacts 11-12 and 21-22 have an approved direct opening mechanism. (→) The terminals 11-42, 21-22, and 51-52 can be used as unlike poles.
D4GL-□EF□-□	2NC/1NO + 1NC/1NO			Only NC contacts 11-12 and 21-22 have an approved direct opening mechanism. (→) The terminals 11-42, 21-22, 33-34, and 53-54 can be used as unlike poles.
D4GL-□FF□-□	2NC/1NO + 2NC			Only NC contacts 11-12 and 21-22 have an approved direct opening mechanism. (→) The terminals 11-42, 21-22, 33-34, and 51-52 can be used as unlike poles.
D4GL-□GF□-□	3NC + 1NC/1NO			Only NC contacts 11-12, 21-22, and 31-32 have an approved direct opening mechanism. (→) The terminals 11-42, 21-22, 31-32, and 53-54 can be used as unlike poles.
D4GL-□HF□-□	3NC + 2NC			Only NC contacts 11-12, 21-22, and 31-32 have an approved direct opening mechanism. (→) The terminals 11-42, 21-22, 31-32, and 51-52 can be used as unlike poles.

Safety Door Switches

D4GL

Indicator

Internal Circuit Diagram

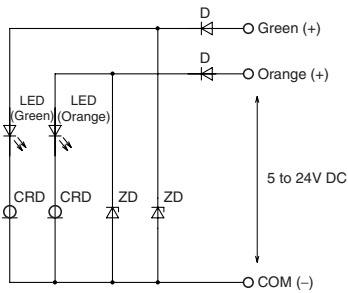

Circuit Connection Example

- Terminals 12 and 41 are connected internally and so connect terminals 11 and 42 for safety-circuit input. (BIA GS-ET-19)
- Connect terminals 21 and 22 and terminals 51 and 52 in series when using as safety-circuit input (redundancy circuit for terminals 11 and 12 and terminals 41 and 42 above). Connect the terminals individually when using as auxiliary-circuit input (e.g., terminals 21 and 22 for safety-door open/closed monitoring and terminals 51 and 52 for monitoring the lock status).
- In the following connection example, terminals 21 and 22 and terminals 51 and 52 are used as auxiliary-circuit input.

Connection Example for D4GL-1HFA-A

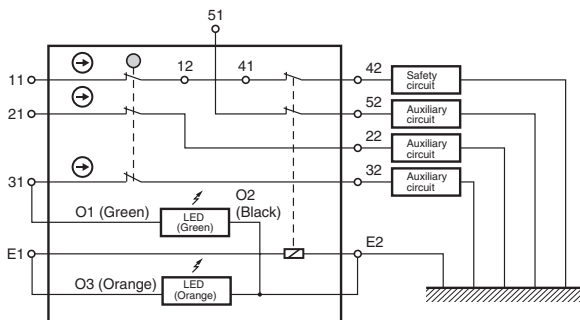

- Direct opening contacts used as safety-circuit input are indicated with the \ominus mark. Terminals 11 and 12 and terminals 21 and 22 are direct opening contacts.
- Connect the indicators in parallel to the auxiliary circuits or terminals E1 and E2.
- Although the 3 lines are connected at the time of delivery, rewire them as necessary for the application.
- The following table shows the connection configuration required to make the green indicator light when the door is closed and the orange indicator light when the solenoid turns ON.

Indicator	Terminal number	Lead wire color	Connected terminal number
Green indicator	O1	Green	31
Orange indicator	O2	Orange	E1
Common	O3	Black	E2

- If an indicator is connected in parallel to a direct opening contact, when the indicator breaks, a short-circuit current will be generated, possibly resulting in an installation malfunction.
- Do not switch standard loads for more than 2 circuits at the same time. Otherwise, the level of insulation may decrease.
- The solenoid has polarity. Be sure to connect terminals with the correct polarity.

Operation Method

■ Operation Principles

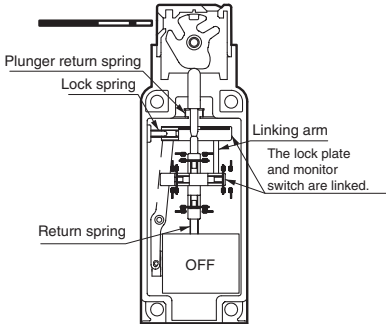
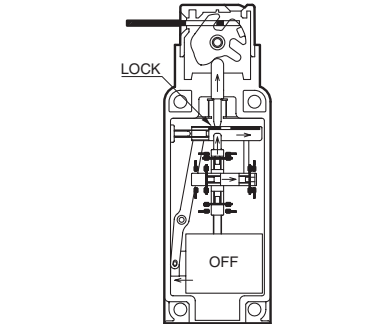
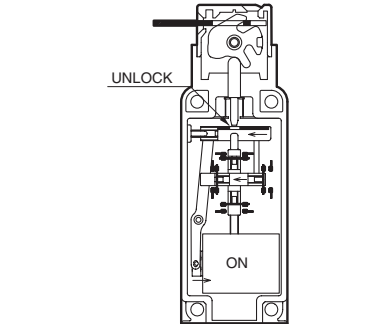
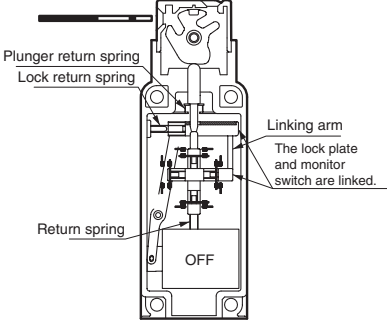
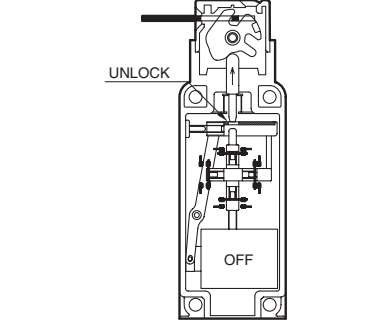
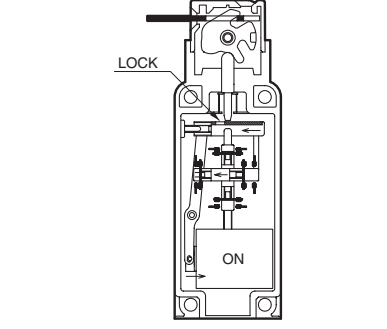
<p>Mechanical lock models</p>		 <p>When the door is closed, it is locked by the lock spring. The door will stay locked even if there is a power interruption.</p>	 <p>The solenoid is released only when the lock is turned ON.</p>
<p>Solenoid lock models</p>		 <p>If the solenoid is OFF, the door will not be locked when it is closed. This means that the door can be opened and closed easily when replacing workpieces or parts.</p>	 <p>The door is locked only when the solenoid is turned ON. This means that the door will be unlocked if there is a power interruption and so this model cannot be used in systems that would maintain a hazardous state (e.g., systems requiring toxic gases, high temperatures, or gears that would continue to turn due to inertia).</p>

Nomenclature

■ Structure

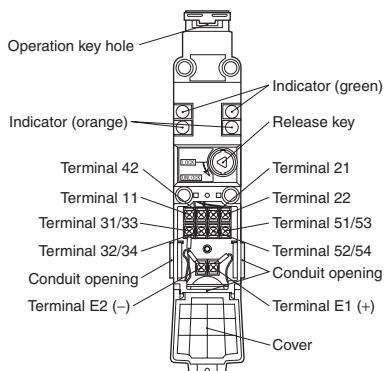

Note: Terminal numbers vary with the model. Confirm terminal numbers by referring to the cover on the back of the Switch.

Safety Door Switches D4GL

Dimensions

Note: All units are in millimeters unless otherwise indicated.

Switches

D4GL-□□□□-A

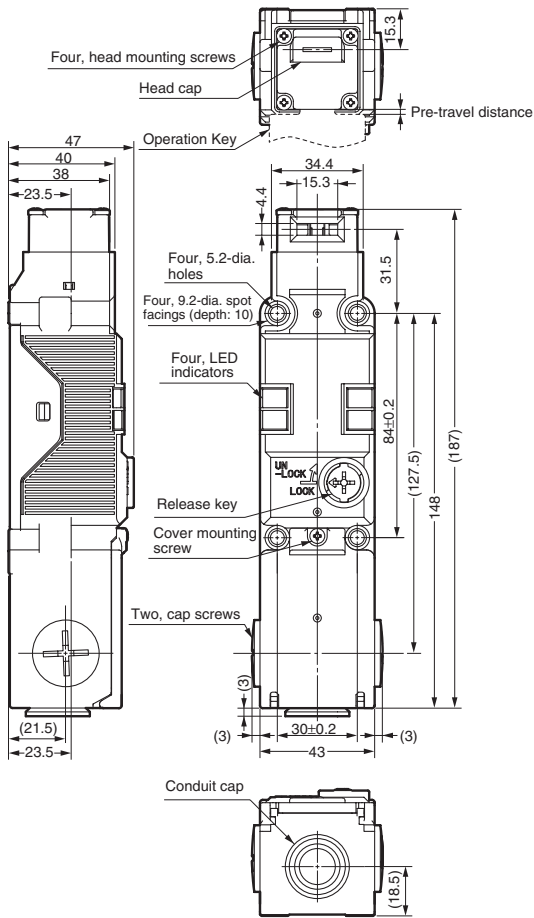

Operating characteristics	D4GL-□□□□-A
Key insertion force	15 N max.
Key extraction force	40 N max.
Pre-travel distance	10 mm max.
Movement before being locked	4 mm min.

D4GL-□□□□-A4

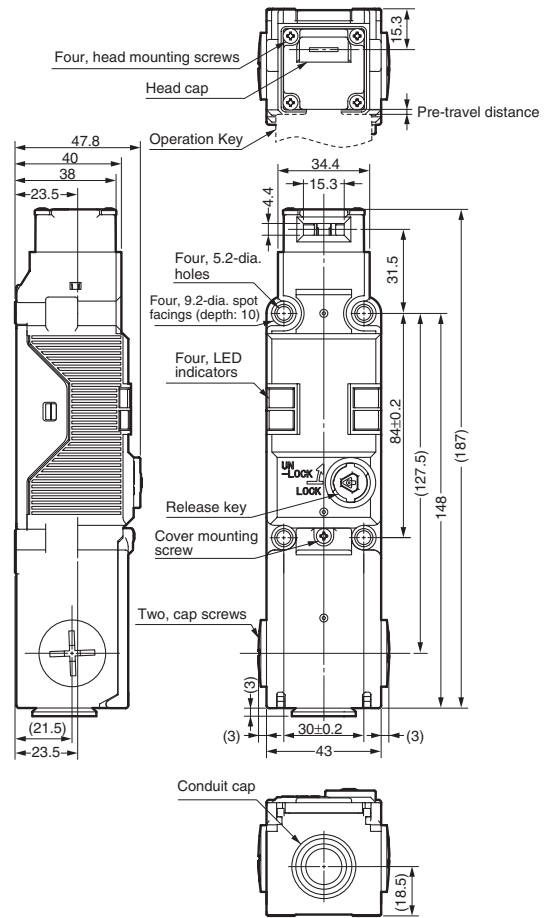

Operating characteristics	D4GL-□□□□-A4
Key insertion force	15 N max.
Key extraction force	40 N max.
Pre-travel distance	10 mm max.
Movement before being locked	4 mm min.

Safety Door Switches
D4GL

Operation Keys

Note: Unless otherwise specified, a tolerance of ± 0.4 mm applies to all dimensions.

D4DS-K1

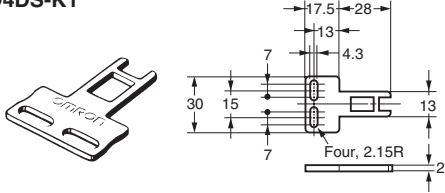

D4DS-K3

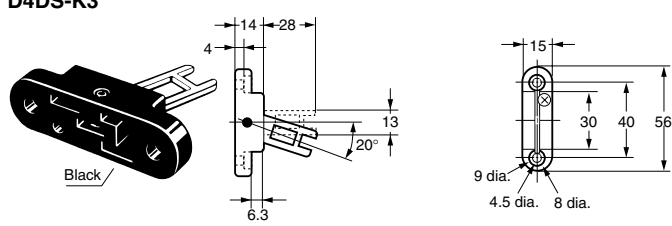

D4DS-K2

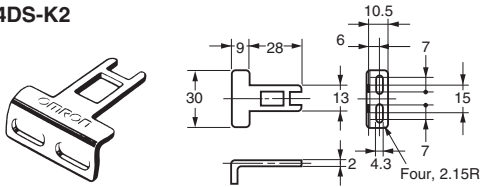

D4DS-K5

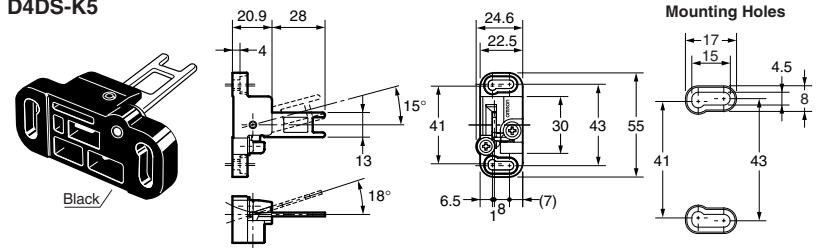

With Operation Key Inserted

D4GL + D4DS-K1

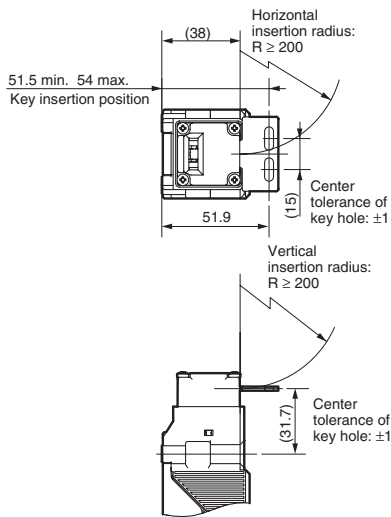

D4GL + D4DS-K2

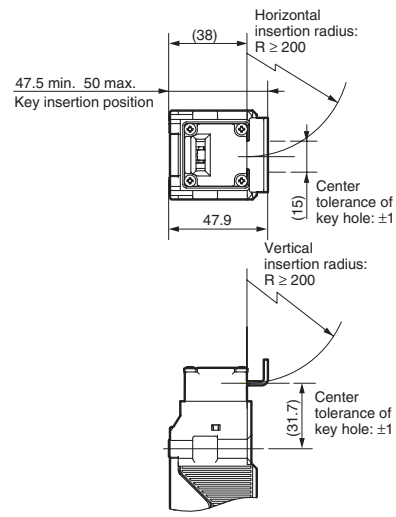

D4GL + D4DS-K3

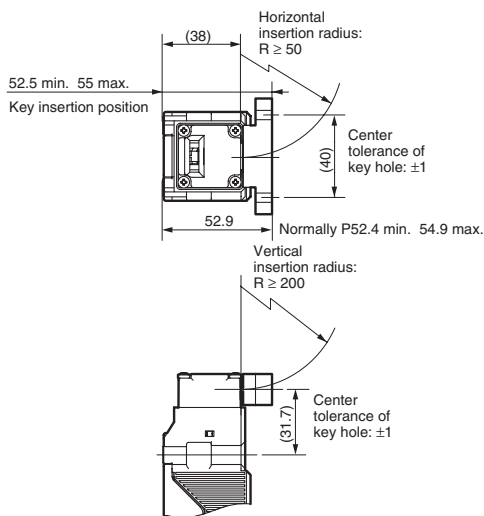

D4GL + D4DS-K5

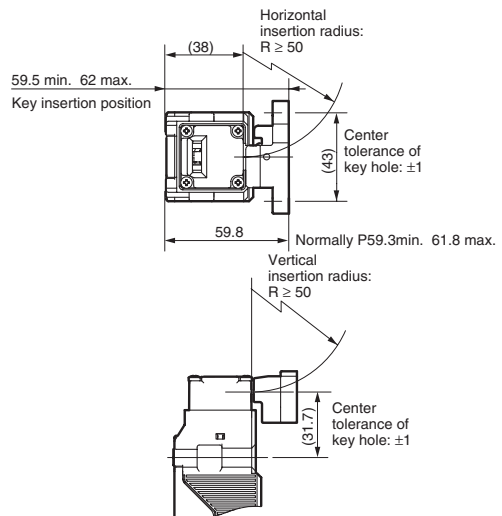

Application Examples

■ G9SA-321-T + D4GL-□□□A-□ (Mechanical Lock Type) Circuit Diagram (Manual Reset)

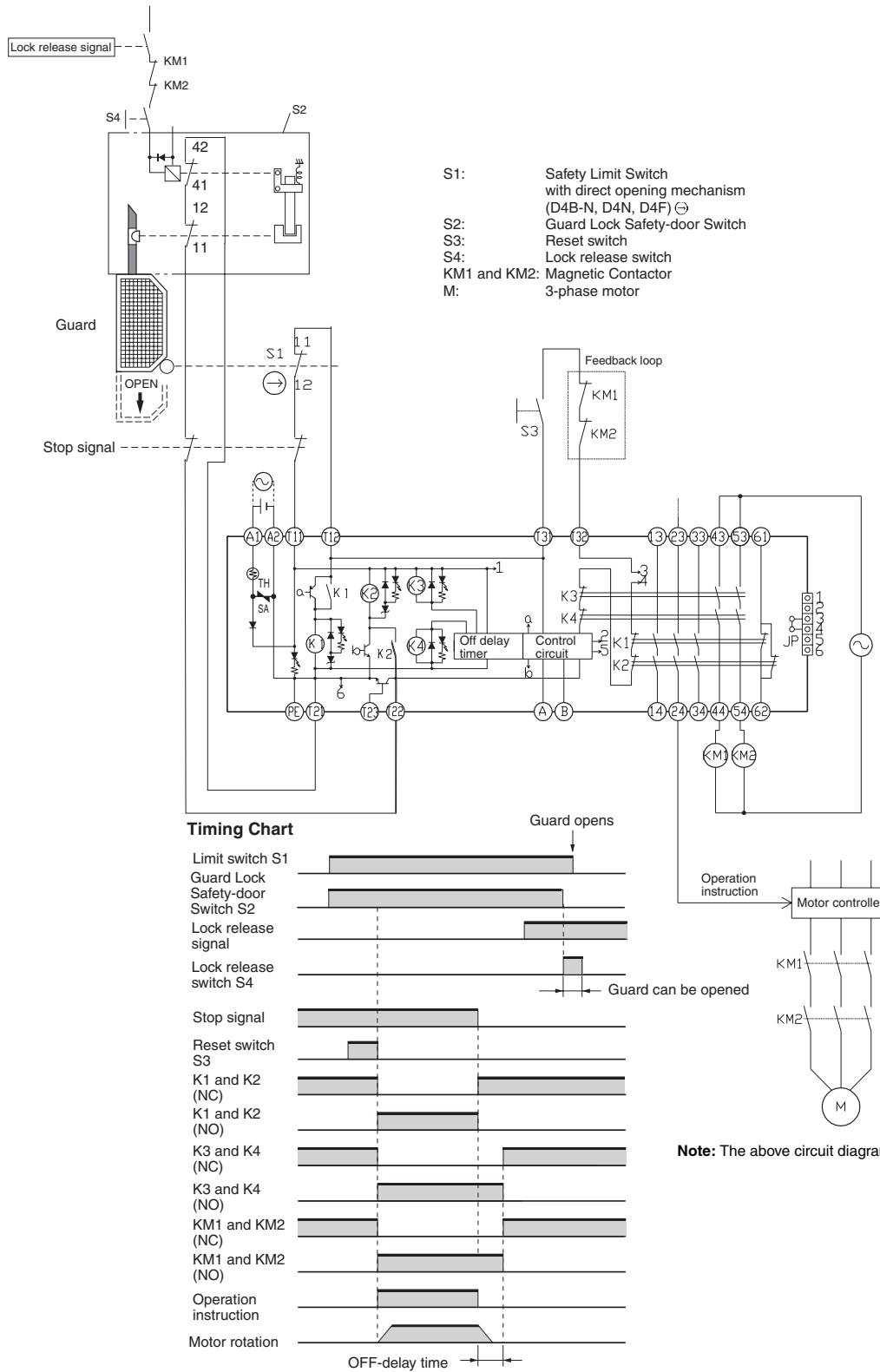

■ G9SA-301 (24 VAC/VDC) + D4GL-□□□G-□ (Solenoid Lock Type) Circuit Diagram (Auto-reset)

Safety Door Switches
D4GL

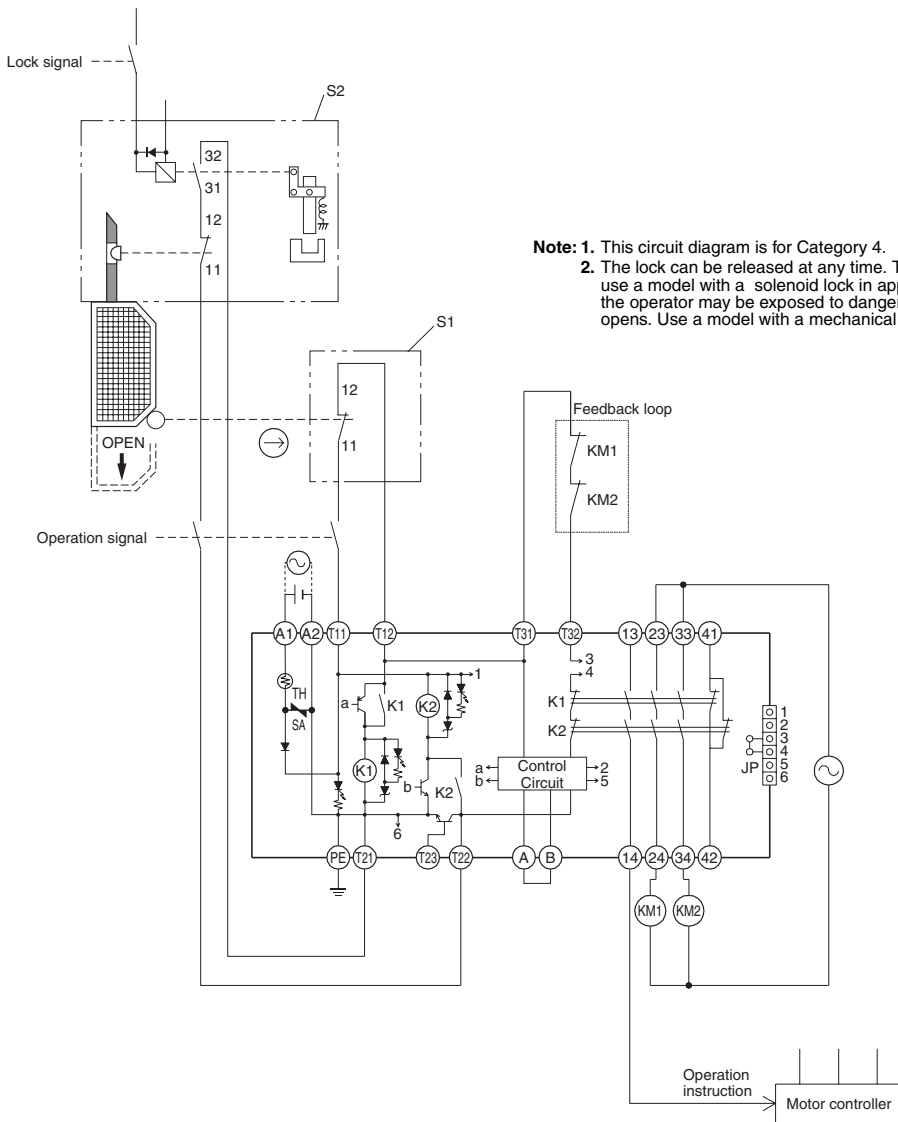

Note: 1. This circuit diagram is for Category 4.
2. The lock can be released at any time. Therefore, do not use a model with a solenoid lock in applications where the operator may be exposed to danger when the guard opens. Use a model with a mechanical lock.

Timing Chart

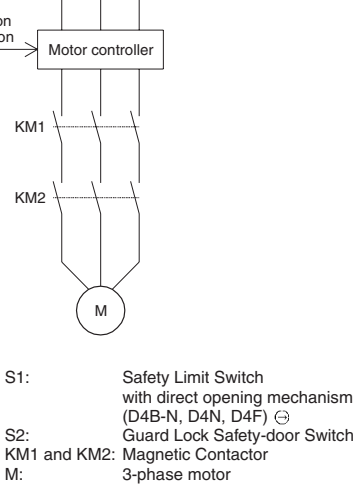
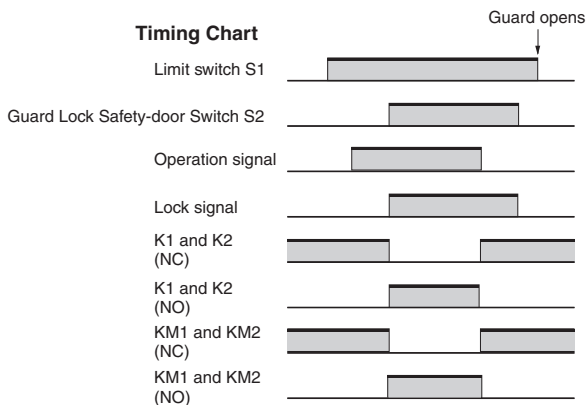

- S1: Safety Limit Switch with direct opening mechanism (D4B-N, D4N, D4F) ⊕
- S2: Guard Lock Safety-door Switch
- KM1 and KM2: Magnetic Contactor
- M: 3-phase motor

Safety Precautions

Refer to the "Precautions for All Switches" on page I-2 and "Precautions for All Safety Door Switches" on page A-2.

CAUTION

Change the head direction after changing the release key to the UNLOCK position. Failure to observe this point may result in Switch malfunction or damage.



Holding Force

- Do not apply a force exceeding the specified holding force. Doing so may break the Switch and the machine may continue to operate.
- Either install another locking component (e.g., a stop) in addition to the Switch, or use a warning sticker or an indicator showing the lock status so that a force exceeding the specified holding force is not applied.

Precautions for Safe Use

- Do not use the Switch submerged in oil or water or in locations continuously subject to splashes of oil or water. Doing so may result in oil or water entering the Switch. (The IP67 degree of protection of the Switch specifies the amount of water penetration after the Switch is submerged in water for a certain period of time.)
- Although the Switch body is protected from the ingress of dust or water, avoid the ingress of foreign substance through the key hole on the head. Otherwise, accelerated wear or breaking may result.
- Always attach the cover after completing wiring and before using the Switch. Electric shock may occur if the Switch is used without the cover attached.
- When switching general loads (125 VAC/1 A), do not operate two circuits or more at the same time. Otherwise, insulation performance may be degraded.
- To prevent burning due to overvoltage, insert a protective fuse in the solenoid circuits.

Stopper Installation

Do not use a Switch as a stopper. Be sure to install a stopper as shown in the following illustration when mounting the Switch so that the base of the Operation Key does not strike the Head.

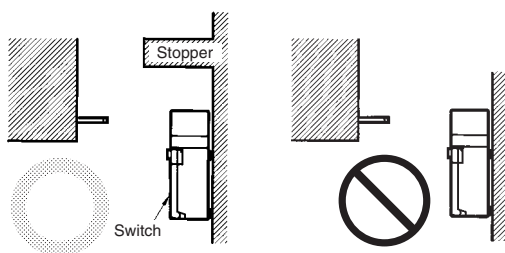

Precautions for Correct Use

The Switch contacts can be used with either standard loads or microloads. Once the contacts have been used to switch a load, however, they cannot be used to switch smaller loads. The contact surfaces will become rough once they have been used and contact reliability for smaller loads may be reduced.

Release Key

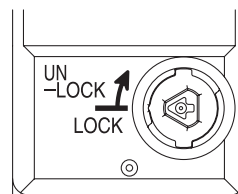

- The release key is used to unlock the Switch in case of emergency or if the power supply to the Switch stops.
- If the release key setting is changed from LOCK to UNLOCK using an appropriate tool, the lock will be released and the safety door can be opened (mechanical lock models only).
- After setting the release key to UNLOCK to, for example, change the head direction or perform maintenance, be sure to return it to LOCK setting before resuming operation.
- If the release key is set to UNLOCK when the Switch is used for the door of a machine room to ensure the safety of people performing adjustment work inside, the door will not be locked when the door is closed and no power will be supplied to the equipment.
- Do not use the release key to start or stop machines.
- The auxiliary lock must be released only by authorized personnel.
- Do not impose excessive force on the release key screws. The release key may be damaged and may not operated properly.
- To prevent easy release of the auxiliary lock by unauthorized personnel, set it to LOCK and seal it with sealing wax.

Hinged Door

If an attempt is made to open the door beyond the lock position when the Switch is used for a hinged door at a location near to the hinged side, where the Operation Key's insertion radius is comparatively small, the force imposed will be much larger than for locations far from the hinged side and the lock may be damaged.

Solenoid Lock Models

The solenoid lock locks the door only when power is supplied to the solenoid. Therefore, the door will be unlocked if the power supply to the solenoid stops. Therefore, do not use solenoid lock models for machines that may be operating and dangerous even after the machine stops operating.

Life Expectancy

The life expectancy of the Switch will vary with the switching conditions. Before applying the Switch, test it under actual operating conditions and be sure to use it at a switching frequency that will not lower its performance.

Mounting

Tightening Torque

Be sure to tighten each screw of the Switch properly. Loose screws may result in malfunction.

Terminal screw	0.4 to 0.5 N·m
Cover mounting screw	0.5 to 0.7 N·m
Head mounting screw	0.5 to 0.6 N·m
Operation Key mounting screw	2.4 to 2.8 N·m
Switch mounting screw	1.3 to 1.5 N·m
Connector	1.8 to 2.1 N·m
Cap screw	1.3 to 1.7 N·m

Switch and Operation Key Mounting

- Mount the Switch and Operation Key securely to the applicable tightening torque with M5 screws.

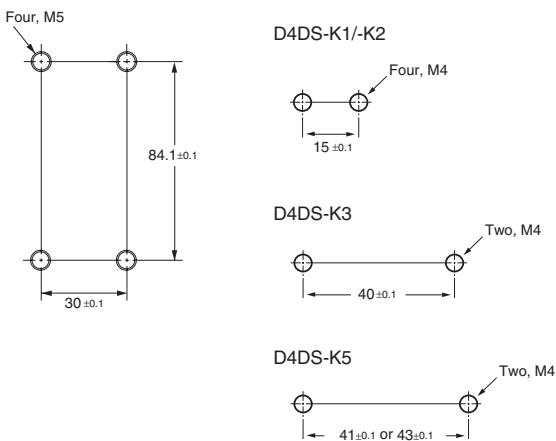

- Use the designated OMRON Operation Key with the Switch. Using another Operation Key may result in Switch damage.
- Ensure that the alignment offset between the Operation Key and the key hole does not exceed ± 1 mm.
- Use the Switch so that the Operation Key is perpendicular to and within the specified insertion radius of the key hole.

Head Direction

- Switch the release key to the UNLOCK position.
- Remove the four screws of the head to enable changing the mounting direction of the head. The head can be mounted in four directions.

Ensure that no foreign material enters the interior of the Switch. Also, insert the head until the insertion line engraved on the head is hidden by the reference line on the Switch, as shown in the following diagram.

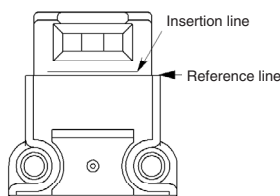

- Return the release key to the LOCK position.

Securing the Door

When the door is closed (with the Operation Key inserted), it may be pulled beyond the set zone because of, for example, the door's weight, or the door cushion rubber. Also, if a load is applied to the Operation Key, the door may fail to unlock properly. Use hooks to ensure that the door stays within the set zone.

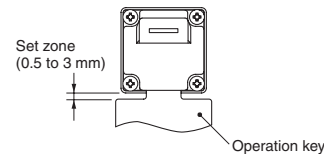

Wiring

Wiring Precautions

- Applicable lead wire size: AWG22 to AWG24.
- When connecting lead wires directly to terminals, perform wiring securely so that there are no loose wire strands.
- Do not push crimp terminals into gaps in the case interior. Doing so may cause damage or deformation of the case.
- Use lead wires of an appropriate length. If lead wires are too long, they will press against the cover causing the cover to not close properly.
- Use crimp terminals not more than 0.5 mm in thickness. Otherwise, they will interfere with other components inside the case.

Manufacturer	Model	Applicable lead wire size
J.S.T. Mfg Co.	FV0.5-3	AWG24 to AWG22 (0.2 to 0.3 mm ²)

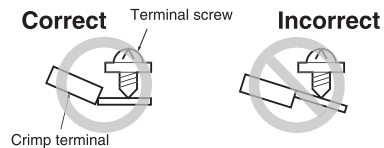
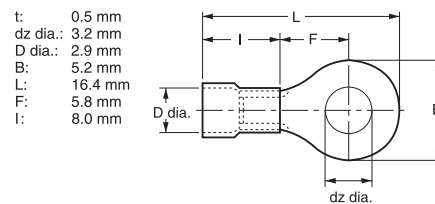

Circuit Connection Example

- Terminals 12 and 41 are connected internally and so connect terminals 11 and 42 for safety-circuit inputs. (BIA GS-ET-19)
- Connect terminals 21 and 22 and terminals 51 and 52 in series when using as safety-circuit inputs (redundancy circuit for terminals 11 and 12 and terminals 41 and 42 below). Connect the terminals individually when using as auxiliary-circuit inputs (e.g., terminals 21 and 22 for safety-door open/closed monitoring and terminals 51 and 52 for monitoring the lock status).
- In the following connection example, terminals 21 and 22 and terminals 51 and 52 are used as auxiliary-circuit inputs.

Connection Example for D4GL-1HFA-A

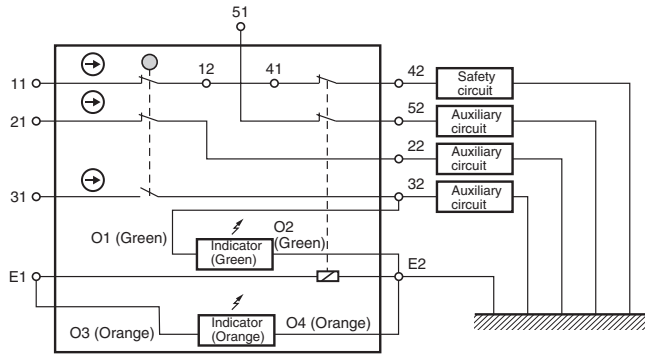

- Direct opening contacts used as safety-circuit inputs are indicated with the ⊖ mark. Terminals 11 and 12, terminals 21 and 22, and terminals 31 and 32 are direct opening contacts.
- Connect the indicators in parallel to the auxiliary circuits or terminals E1 and E2.
- Although the 3 lines are connected at the time of delivery, rewire them as necessary for the application.
- The following table shows the connection configuration required to make the green indicator light when the door is closed and the orange indicator light when the solenoid turns ON.

Indicator	Terminal number	Lead wire color	Connected terminal number
Green indicator	O1	Green	32
Orange indicator	O2	Orange	E1
Common	O3	Black	E2

- If an indicator is connected in parallel to a direct opening contact, when the indicator breaks, a short-circuit current will be generated, possibly resulting in an installation malfunction.
- Do not switch standard loads for more than 2 circuits at the same time. Otherwise, the level of insulation may decrease.
- The solenoid has polarity. Be sure to connect terminals with the correct polarity.

Conduit Opening

- Connect a recommended connector to the opening of the conduit and tighten the connector to the proper torque. The case may be damaged if an excessive tightening torque is applied.
- To ensure IP67 degree of protection, wrap sealing tape around the conduit end of the connector.
- Be sure that the outer diameter of the cable connected to the connector is correct.
- Attach and tighten a conduit cap to the unused conduit opening when wiring. The conduit cap is provided with the Switch.

ALL DIMENSIONS SHOWN ARE IN MILLIMETERS.
To convert millimeters into inches, multiply by 0.03937. To convert grams into ounces, multiply by 0.03527.

Cat. No. C125-E1-03

In the interest of product improvement, specifications are subject to change without notice.

Recommended Connectors

Use a connector with a screw section not exceeding 10 mm, otherwise the screws will protrude into the case interior. The connectors given in the following table have connectors with screw sections not exceeding 10 mm.

Size	Manufacturer	Model	Applicable cable diameter
G ¹ / ₂	LAPP	ST-PF1/2 5380-1002	6.0 to 12.0 mm
	OHM ELECTRIC CO.	OA-W1609	7.0 to 9.0 mm
OA-W1611		9.0 to 11.0 mm	
Pg13.5	LAPP	S-13.5 5301-5030	5.0 to 12.0 mm
M20	LAPP	ST-M20 × 1.5 5311-1020	7.0 to 13.0 mm

Use LAPP connectors together with Seal Packing (JPK-16, GP-13.5, or GPM20), and tighten to the applicable torque. Seal Packing is sold separately.

Miscellaneous

- In conditions requiring greater rigidity, sealing performance, and oil resistance, use OMRON's D4BL.

Safety Door Switches
D4GL

Terms and Conditions of Sale

- Offer; Acceptance.** These terms and conditions (these "Terms") are deemed part of all quotes, agreements, purchase orders, acknowledgments, price lists, catalogs, manuals, brochures and other documents, whether electronic or in writing, relating to the sale of products or services (collectively, the "Products") by Omron Electronics LLC and its subsidiary companies ("Omron"). Omron objects to any terms or conditions proposed in Buyer's purchase order or other documents which are inconsistent with, or in addition to, these Terms.
- Prices; Payment Terms.** All prices stated are current, subject to change without notice by Omron. Omron reserves the right to increase or decrease prices on any unshipped portions of outstanding orders. Payments for Products are due net 30 days unless otherwise stated in the invoice.
- Discounts.** Cash discounts, if any, will apply only on the net amount of invoices sent to Buyer after deducting transportation charges, taxes and duties, and will be allowed only if (i) the invoice is paid according to Omron's payment terms and (ii) Buyer has no past due amounts.
- Interest.** Omron, at its option, may charge Buyer 1-1/2% interest per month or the maximum legal rate, whichever is less, on any balance not paid within the stated terms.
- Orders.** Omron will accept no order less than \$200 net billing.
- Governmental Approvals.** Buyer shall be responsible for, and shall bear all costs involved in, obtaining any government approvals required for the importation or sale of the Products.
- Taxes.** All taxes, duties and other governmental charges (other than general real property and income taxes), including any interest or penalties thereon, imposed directly or indirectly on Omron or required to be collected directly or indirectly by Omron for the manufacture, production, sale, delivery, importation, consumption or use of the Products sold hereunder (including customs duties and sales, excise, use, turnover and license taxes) shall be charged to and remitted by Buyer to Omron.
- Financial.** If the financial position of Buyer at any time becomes unsatisfactory to Omron, Omron reserves the right to stop shipments or require satisfactory security or payment in advance. If Buyer fails to make payment or otherwise comply with these Terms or any related agreement, Omron may (without liability and in addition to other remedies) cancel any unshipped portion of Products sold hereunder and stop any Products in transit until Buyer pays all amounts, including amounts payable hereunder, whether or not then due, which are owing to it by Buyer. Buyer shall in any event remain liable for all unpaid accounts.
- Cancellation; Etc.** Orders are not subject to rescheduling or cancellation unless Buyer indemnifies Omron against all related costs or expenses.
- Force Majeure.** Omron shall not be liable for any delay or failure in delivery resulting from causes beyond its control, including earthquakes, fires, floods, strikes or other labor disputes, shortage of labor or materials, accidents to machinery, acts of sabotage, riots, delay in or lack of transportation or the requirements of any government authority.
- Shipping; Delivery.** Unless otherwise expressly agreed in writing by Omron:
 - Shipments shall be by a carrier selected by Omron; Omron will not drop ship except in "break down" situations.
 - Such carrier shall act as the agent of Buyer and delivery to such carrier shall constitute delivery to Buyer;
 - All sales and shipments of Products shall be FOB shipping point (unless otherwise stated in writing by Omron), at which point title and risk of loss shall pass from Omron to Buyer; provided that Omron shall retain a security interest in the Products until the full purchase price is paid;
 - Delivery and shipping dates are estimates only; and
 - Omron will package Products as it deems proper for protection against normal handling and extra charges apply to special conditions.
- Claims.** Any claim by Buyer against Omron for shortage or damage to the Products occurring before delivery to the carrier must be presented in writing to Omron within 30 days of receipt of shipment and include the original transportation bill signed by the carrier noting that the carrier received the Products from Omron in the condition claimed.
- Warranties.** (a) **Exclusive Warranty.** Omron's exclusive warranty is that the Products will be free from defects in materials and workmanship for a period of twelve months from the date of sale by Omron (or such other period expressed in writing by Omron). Omron disclaims all other warranties, express or implied. (b) **Limitations.** OMRON MAKES NO WARRANTY OR REPRESENTATION, EXPRESS OR IMPLIED, ABOUT NON-INFRINGEMENT, MERCHANTABILITY OR FITNESS FOR A PARTICULAR PURPOSE OF THE PRODUCTS. BUYER ACKNOWLEDGES THAT IT ALONE HAS DETERMINED THAT THE PRODUCTS WILL SUITABLY MEET THE REQUIREMENTS OF THEIR INTENDED USE. Omron further disclaims all warranties and responsibility of any type for claims or expenses based on infringement by the Products or otherwise of any intellectual property right. (c) **Buyer Remedy.** Omron's sole obligation hereunder shall be, at Omron's election, to (i) replace (in the form originally shipped with Buyer responsible for labor charges for removal or replacement thereof) the non-complying Product, (ii) repair the non-complying Product, or (iii) repay or credit Buyer an amount equal to the purchase price of the non-complying Product; provided that in no event shall Omron be responsible for warranty, repair, indemnity or any other claims or expenses regarding the Products unless Omron's analysis confirms that the Products were properly handled, stored, installed and maintained and not subject to contamination, abuse, misuse or inappropriate modification. Return of any Products by Buyer must be approved in writing by Omron before shipment. Omron Companies shall not be liable for the suitability or unsuitability or the results from the use of Products in combination with any electrical or electronic components, circuits, system assemblies or any other materials or substances or environments. Any advice, recommendations or information given orally or in writing, are not to be construed as an amendment or addition to the above warranty. See <http://oeweb.omron.com> or contact your Omron representative for published information.
- Limitation on Liability; Etc.** OMRON COMPANIES SHALL NOT BE LIABLE FOR SPECIAL, INDIRECT, INCIDENTAL, OR CONSEQUENTIAL DAMAGES, LOSS OF PROFITS OR PRODUCTION OR COMMERCIAL LOSS IN ANY WAY CONNECTED WITH THE PRODUCTS, WHETHER SUCH CLAIM IS BASED IN CONTRACT, WARRANTY, NEGLIGENCE OR STRICT LIABILITY. Further, in no event shall liability of Omron Companies exceed the individual price of the Product on which liability is asserted.
- Indemnities.** Buyer shall indemnify and hold harmless Omron Companies and their employees from and against all liabilities, losses, claims, costs and expenses (including attorney's fees and expenses) related to any claim, investigation, litigation or proceeding (whether or not Omron is a party) which arises or is alleged to arise from Buyer's acts or omissions under these Terms or in any way with respect to the Products. Without limiting the foregoing, Buyer (at its own expense) shall indemnify and hold harmless Omron and defend or settle any action brought against such Companies to the extent based on a claim that any Product made to Buyer specifications infringed intellectual property rights of another party.
- Property; Confidentiality.** Any intellectual property in the Products is the exclusive property of Omron Companies and Buyer shall not attempt to duplicate it in any way without the written permission of Omron. Notwithstanding any charges to Buyer for engineering or tooling, all engineering and tooling shall remain the exclusive property of Omron. All information and materials supplied by Omron to Buyer relating to the Products are confidential and proprietary, and Buyer shall limit distribution thereof to its trusted employees and strictly prevent disclosure to any third party.
- Export Controls.** Buyer shall comply with all applicable laws, regulations and licenses regarding (i) export of products or information; (ii) sale of products to "forbidden" or other proscribed persons; and (iii) disclosure to non-citizens of regulated technology or information.
- Miscellaneous.** (a) **Waiver.** No failure or delay by Omron in exercising any right and no course of dealing between Buyer and Omron shall operate as a waiver of rights by Omron. (b) **Assignment.** Buyer may not assign its rights hereunder without Omron's written consent. (c) **Law.** These Terms are governed by the law of the jurisdiction of the home office of the Omron company from which Buyer is purchasing the Products (without regard to conflict of law principles). (d) **Amendment.** These Terms constitute the entire agreement between Buyer and Omron relating to the Products, and no provision may be changed or waived unless in writing signed by the parties. (e) **Severability.** If any provision hereof is rendered ineffective or invalid, such provision shall not invalidate any other provision. (f) **Setoff.** Buyer shall have no right to set off any amounts against the amount owing in respect of this invoice. (g) **Definitions.** As used herein, "including" means "including without limitation"; and "Omron Companies" (or similar words) mean Omron Corporation and any direct or indirect subsidiary or affiliate thereof.

Certain Precautions on Specifications and Use

- Suitability of Use.** Omron Companies shall not be responsible for conformity with any standards, codes or regulations which apply to the combination of the Product in the Buyer's application or use of the Product. At Buyer's request, Omron will provide applicable third party certification documents identifying ratings and limitations of use which apply to the Product. This information by itself is not sufficient for a complete determination of the suitability of the Product in combination with the end product, machine, system, or other application or use. Buyer shall be solely responsible for determining appropriateness of the particular Product with respect to Buyer's application, product or system. Buyer shall take application responsibility in all cases but the following is a non-exhaustive list of applications for which particular attention must be given:
 - Outdoor use, uses involving potential chemical contamination or electrical interference, or conditions or uses not described in this document.
 - Use in consumer products or any use in significant quantities.
 - Energy control systems, combustion systems, railroad systems, aviation systems, medical equipment, amusement machines, vehicles, safety equipment, and installations subject to separate industry or government regulations.
 - Systems, machines and equipment that could present a risk to life or property. Please know and observe all prohibitions of use applicable to this Product.

NEVER USE THE PRODUCT FOR AN APPLICATION INVOLVING SERIOUS RISK TO LIFE OR PROPERTY OR IN LARGE QUANTITIES WITHOUT ENSURING THAT THE SYSTEM AS A WHOLE HAS BEEN DESIGNED TO ADDRESS THE RISKS, AND THAT THE OMRON'S PRODUCT IS PROPERLY RATED AND INSTALLED FOR THE INTENDED USE WITHIN THE OVERALL EQUIPMENT OR SYSTEM.
- Programmable Products.** Omron Companies shall not be responsible for the user's programming of a programmable Product, or any consequence thereof.
- Performance Data.** Data presented in Omron Company websites, catalogs and other materials is provided as a guide for the user in determining suitability and does not constitute a warranty. It may represent the result of Omron's test conditions, and the user must correlate it to actual application requirements. Actual performance is subject to the Omron's Warranty and Limitations of Liability.
- Change in Specifications.** Product specifications and accessories may be changed at any time based on improvements and other reasons. It is our practice to change part numbers when published ratings or features are changed, or when significant construction changes are made. However, some specifications of the Product may be changed without any notice. When in doubt, special part numbers may be assigned to fix or establish key specifications for your application. Please consult with your Omron's representative at any time to confirm actual specifications of purchased Product.
- Errors and Omissions.** Information presented by Omron Companies has been checked and is believed to be accurate; however, no responsibility is assumed for clerical, typographical or proofreading errors or omissions.

Complete “Terms and Conditions of Sale” for product purchase and use are on Omron’s website at www.omron.com/oei – under the “About Us” tab, in the Legal Matters section.

ALL DIMENSIONS SHOWN ARE IN MILLIMETERS.

To convert millimeters into inches, multiply by 0.03937. To convert grams into ounces, multiply by 0.03527.

OMRON[®]**OMRON ELECTRONICS LLC**

One Commerce Drive
Schaumburg, IL 60173

847-843-7900

For US technical support or other inquiries:

800-556-6766**OMRON CANADA, INC.**

885 Milner Avenue
Toronto, Ontario M1B 5V8

416-286-6465**OMRON ON-LINE**

Global - <http://www.omron.com>
USA - <http://www.omron.com/oei>
Canada - <http://www.omron.ca>