





7T.81



	7T.81.0.000.240x	7T.81.0.000.230x
	1 NC (SPST-NC) 10 A 250 V AC	1 NO (SPST-NO) 10 A 250 V AC
	AC1 AC15 (230 V AC) AC3 (230 V AC) DC1(30/110/220)V	2500 VA 250 VA 0.125 kW (1/0.3/0.15)A
K	7 ± 4	
	(-45...+80)°C	
IP20		

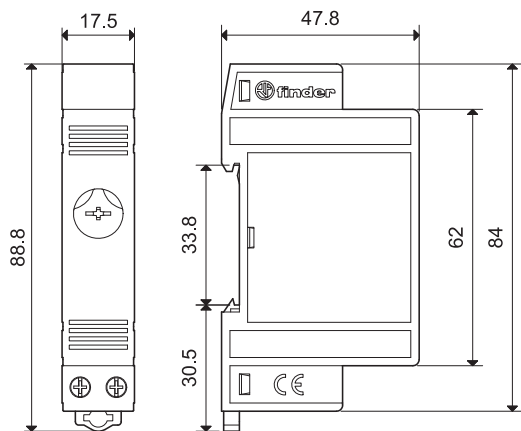

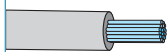
		
0.5 Nm	(1x2.5) mm² (1x12) AWG	(1x1.5) mm² (1x16) AWG

7T.81.0.000.2401 (-20...+40)°C
 7T.81.0.000.2403 (0...+60)°C

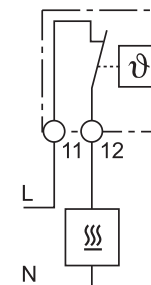
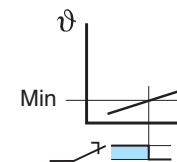
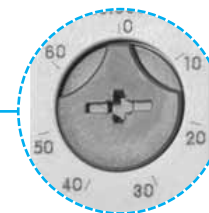
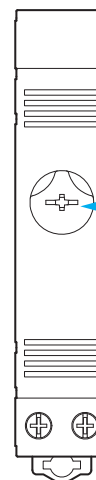

7T.81.0.000.2301 (-20...+40)°C
 7T.81.0.000.2303 (0...+60)°C

