



CT series

M30 cylindrical capacitive sensors



M30 cylindrical

features

- Sensitivity adjustment with trimmer
- Metal housing
- IP65 protection degree
- Complete protection against electrical damages
- Axial cable exit or M12 plug cable exit



web contents



- Application notes
- Photos
- Catalogue / Manuals



code description

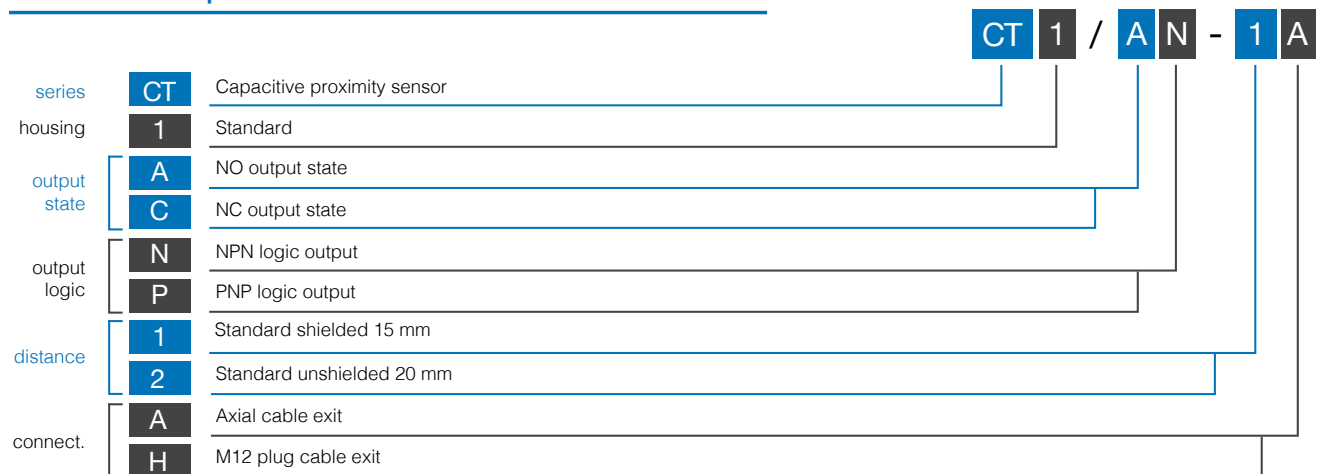

available models

diameter	installation	distance (mm)	plug	NPN/NO	NPN/NC	PNP/NO	PNP/NC
M30	shielded	15	cable	CT1/AN-1A	CT1/CN-1A	CT1/AP-1A	CT1/CP-1A
			M12	CT1/AN-1H	CT1/CN-1H	CT1/AP-1H	CT1/CP-1H
	unshielded	20	cable	CT1/AN-2A	CT1/CN-2A	CT1/AP-2A	CT1/CP-2A
			M12	CT1/AN-2H	CT1/CN-2H	CT1/AP-2H	CT1/CP-2H

C class codes

Note: The class C products could be subject to delays in delivery terms or limits for the quantities to be ordered

technical specification

M30 cylindrical

	CT1/0*-1*	CT2/0*-1*
		
nominal sensing distance Sn	2...15 mm	2...20 mm
operating distance	2...12 mm	2...16 mm
hysteresis	2...20 %	
repeatability	10 %	
supply voltage	10...30 Vdc	
ripple	≤ 10 %	
no-load supply current	8 mA	
load current	≤ 200 mA	
leakage current	≤ 10 mA	
voltage drop	0.75/1.8 V max. IL=10/200 mA	
output type	NPN or PNP - NO or NC - open collector	
switching frequency	100 Hz	
time delay before availability	100 ms	
power supply protections	impulsive polarity reversal, transient	
output protection	short circuit (autoreset)	
temperature range	-25°...+70°C	
temperature drift	20% Sr	
EMC	in conformity with the EMC Directive according to IEC 60947-5-2	
shocks and vibrations	IEC 60947-5-2	
protection degree	IP 65	
LEDs	green (supply), red (output energized)	
housing material	nichel plated brass	
active head material	PBT	
weight	185 g M12 connector 260 g cable	
tightening torque	50 Nm	

electrical diagrams of connections

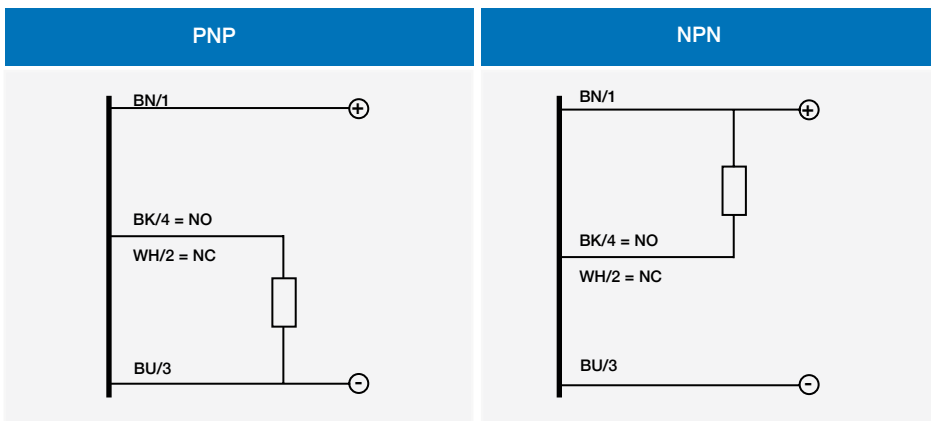



response diagram

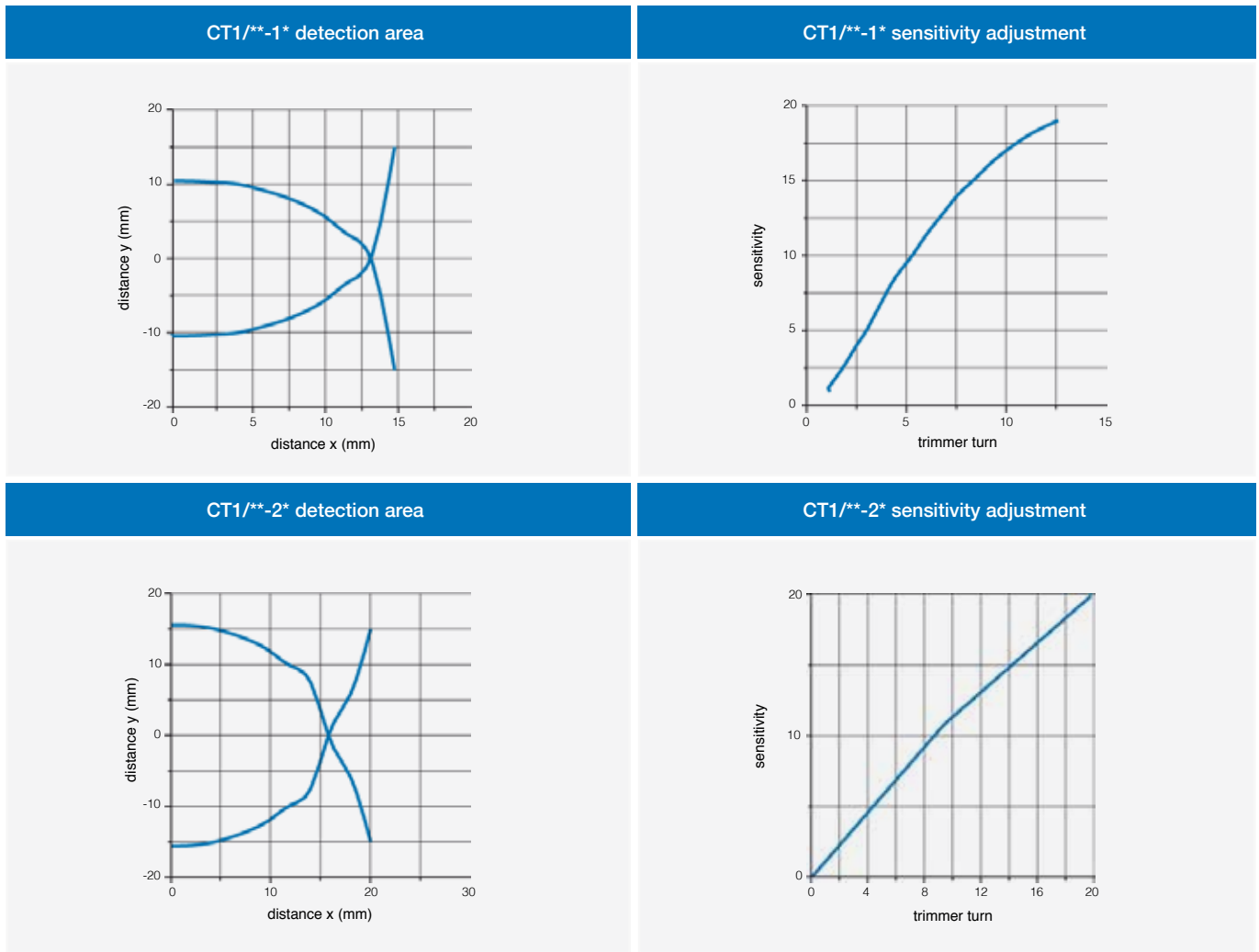

CT1/**-1A

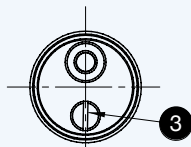
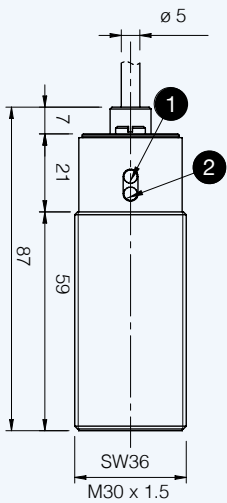

CT1/**-1H

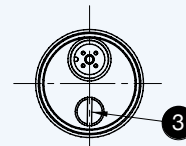
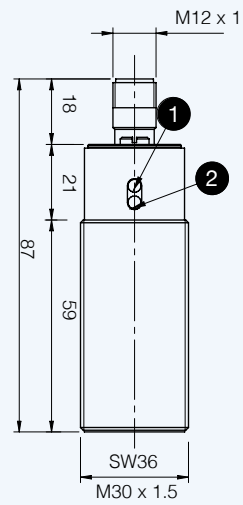



CT1/**-2A

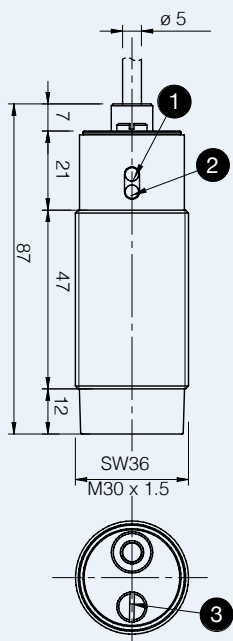

CT1/**-2H

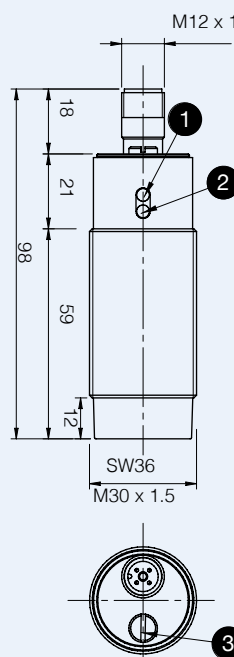

- 1 red LED (supply)
- 2 yellow LED (active NO output)
- 3 TRIMMER

dimensions (mm)

accessories included in all models

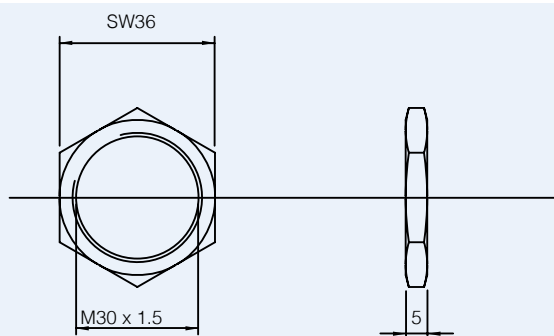

metallic nut (2 x)