



TR-4400

2/ 3/ 4-Wire Digital
Earth Resistance Tester



TR-4400

2/ 3/ 4-Wire Digital Earth Resistance
Tester

8-2 Earth Resistivity (Ω) Measurement

Making a setting of the interval between Auxiliary Earth Spikes first and measuring the earth resistance with the 4 Auxiliary Earth Spikes stuck into the ground at even intervals. Then the instrument can calculate and display earth resistivity on the LCD automatically.

Terminals to be used : E, ES, S(P), H(C) Terminals

Test Leads : connect to the E, ES, S(P) and H(C) Terminals

Auxiliary Earth Spike: 4 pcs

(1) Setting of Wiring System

Select wire (ρ) with reference to 7-2-2 Setting for measurement in this manual.

Note) The instrument doesn't accept any setting change on R_k while measuring earth resistivity(ρ).

(2) Connection of Auxiliary Earth Spikes and Test Leads (Reference To Fig. 25)

Stick the four Auxiliary Earth Spikes into the ground deeply. They should be aligned at an interval of 1-30m. The depth should be 5% or less of the interval between the spikes. (e.g. The spike should be stuck in the depth of 25cm or less when the interval of the Auxiliary Earth Spikes is 5m.) If the Spikes stuck too deep, it may result in inaccurate earth resistivity measurement.

Note) The supplied Test Leads can be used for the Spikes stuck at the interval of max 20m.

Connect the green, black, yellow Test Leads connected to the E, ES, S(P) and H(C) Terminals on the instrument to the Auxiliary Earth Spikes from the closest to the farthest in this order.

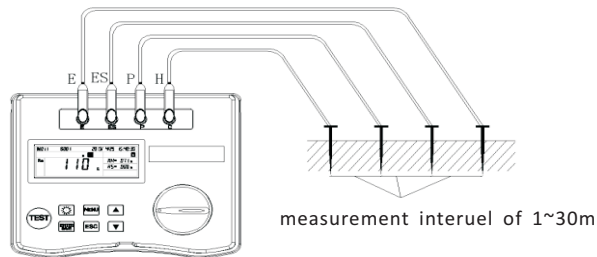

Fig.25

(3) Setting of the Interval between Auxiliary Earth Spikes

The interval of the Spikes should be entered according to the setting made at the step of 7-2-4 Setting for the interval between Auxiliary Earth Spikes at Earth Resistivity (ρ)

(4) Earth Resistivity (ρ) Measurement

Select a Range (any Range is ok) when the connection is done, and press the TEST Button. Then the measured earth resistivity (ρ) and the earth resistance R_g between the ES-S Terminals are displayed.

Press the down-arrow Key to display every information.

Press the up-arrow Key to return to the Main Screen.

If the R_g value is too large, rotate the Range Switch and select an upper Range.

Press the up-arrow Key to switch the screen from the result of testing ρ and the setting for the interval between Auxiliary Earth Spikes. And then set the interval between Auxiliary Earth Spikes (L_h), which is referenced to 7-2-4.

9. Batteries Replacement

· When the cover is wet, do not open the battery cover.

· Please do not replace the batteries when the instrument testing; Avoid electrical shock, Turn the range switch to OFF before replace the batteries, and remove the test leads and auxiliary earth spikes.

· Unscrew the battery cover screw and open the battery cover Replace the new batteries, put the battery cover and tighten the screws.

10. Accessories

4x Auxiliary Earth Spikes

4 x Earth Test Leads (one Red Earth Test Leads 15 meters, one Yellow Earth Test Leads 10 meters, one Green Earth Test Leads 5 meters, one Black Earth Test Leads 5 meters)

8 x 1.5V(AA) Batteries

1 x manual

1 x Bags

CONTENTS

1. Safety Warnings.....	1
2. Features.....	3
3. Specifications.....	3
4. Names of parts.....	5
5. Marks and messages on the LCD.....	6
6. Measurement Principle.....	6
6-1. Principle of Earth Resistance Measurements.....	6
6-2. Principle of Earth Resistivity (Ω) Measurements.....	7
7. Preparation for Measurement.....	7
7-1. Battery Voltage Check.....	7
7-2. Test parameter setting.....	7
7-2-1 Setting Items.....	7
7-2-2 Setting for Measurement Method.....	8
7-2-3 Site (location) No. Setting.....	9
7-2-4 Setting for the interval between Auxiliary Earth Spikes at Earth Resistivity (Ω).....	10
7-2-5 Date and time setting.....	11
7-2-6 Setting for the residual resistance (R_k) on the Test Leads.....	12
7-3 Backlight.....	12
7-4 Auto-Power-Off.....	13
7-5 Auxiliary Earth Resistance Measurement.....	13
7-6 Connection of Earth Test Leads and Simplified Measurement Probes.....	13
8 Measurement Method.....	13
8-1 Earth Resistance Measurement.....	13
8-1-1 Precise Measurement (3-Wire).....	13
8-1-2 Precise Measurement (4-Wire).....	14
8-1-3 Simplified Measurement (2-Wire).....	15
8-2 Earth Resistivity (Ω).....	16
9. Batteries replacement.....	16
10. Accessories.....	16

1. SAFETY WARNINGS

This instrument has been designed, manufactured and tested according to IEC 61010: Safety requirements for Electronic Measuring apparatus, and delivered in the best condition after passing quality control tests.

This instrument manual contains warnings and safety rules which have to be observed by the user to ensure safe operation of the instrument and to maintain it in safe condition. Therefore, read through these operating instructions before using the instrument.

⚠ WARNING

- Please carefully read this manual before use.
- Keep custody in order to access when needed.
- Please carry this manual with you in order to consult when needed.
- Please observe the instrument to use is specified in the manual.
- Understand and follow the safety instructions in the book. Must strictly comply with the above instructions. Failure to comply with instructions may result in injuries and accidents.

Instrument of ⚠ signs in order to use security, you must read the instruction manual.

⚠The flag is divided into the following three kinds of attention to its content.

⚠ DANGER: Indicates to ignore this flag to wrongly operating, resulting in a high risk of death or serious injury.

⚠ WARNING: Indicates to ignore this flag to wrongly operating may cause death or serious injury.

⚠ Note: to ignore this flag to wrongly operating may cause death or serious injury and equipment and other items of damage.

⚠ Danger

- Do not use loop-to-ground voltage AC/DC300V above.
 - Do not measured in inflammable places, may spark and cause an explosion.
 - Do not use the instrument when it is damp or with wet hands.
 - Please note that the simple measurement not to cause the metal head of the test line and short-circuit of the power cord. Doing so may cause personal injury.
 - Do not exceed the test range when testing.
 - When the test lines are connected, do not press the test button
- Do not open the battery cover when testing.



⚠ Warning

- If the instrument or the test lines crack or metal parts expose, stop testing immediately.
- Do not switch range when the analyte is connected with the test line.
- Do not remove the instrument to carry out the decomposition, alteration, replacement alternative parts.
- Repair or adjustment is required, please contact us.
- When the instrument is wet, do not replace the battery.
- When using the test line, make sure the plug is fully inserted.
- When open the battery cover and replace the batteries, please set the range switch to OFF.

Note

- Before the test, make sure that the range switch is set in the appropriate range.
- After use, set the range switch to OFF, and remove the testing line. Remove the battery, if long time not in use.
- Do not place the instrument in high temperature, humidity, dew and direct sunlight place.
- Do not use abrasives or solvents to clean instrument. Please use the cloth to clean with neutral detergent or water.
- Keep dry storage.
- To ensure safety, please use in the temperature range -10 °C ~ 50 °C, height of 2000m or less.

SYMBOL

CAT.IV	The circuit from the service drop the service entrance, and to the power meter and primary overcurrent protection device(distribution panel)
CAT.III	Primary electrical circuits of the equipment connected directly to the distribution panel, and feeders from the distribution panel to outlets.
	Instrument with double or reinforced insulation.
	User must refer to the explanations in the instruction manual.

This instrument meets CAT.III 300V/CAT.IV 150V. To ensure safe operation of measuring instruments, IEC 61010 established safety standards for various electrical environments, categorized as CAT.I to CAT.IV, and called measurement categories. High-numbered categories correspond to electrical environments with greater momentary energy, so a measuring instrument designed for CAT.III environments can endure greater momentary energy than one designed for CAT.II.

CAT.I: Secondary electrical circuits connected to an AC electrical outlet through a transformer or similar device.

CAT.II: Primary electrical circuits of equipment connected to an AC electrical outlet by a power cord.

CAT.III: See above table

CAT.IV: See above table

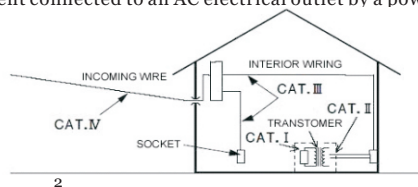

(4) Earth Resistance Measurement

Select a Range (any Range is ok) when the connection is done, and press the TEST Button. The measured earth resistances R_e are displayed on the LCD.

The operation procedure is same to that for 3-Wire measurements.

Note) The readings may not correct when the auxiliary earth resistance is too high. Stick the Auxiliary Earth Spikes S(P) and H(C) in the moist part of the soil, and make sure the fully contact of all connected parts.

Note) If a message $R_h > \text{limit}$ or $R_s > \text{limit}$ appear on the LCD, auxiliary earth resistance is too high to make measurements. Recheck the connection of Test Leads. If it has to be measured at the dry place or that with much little stone, please water the point in which the auxiliary earth spikes are pressed. Be sure to keep it wet. While making the measurement on concrete, the auxiliary earth spikes flat flooding or use wet cloth into the auxiliary earth spikes for testing.

8-1-3 Simplified Measurement (2-Wire) with Simplified Test Probes

Use this method when the Auxiliary Earth Spike cannot be stuck. In this method, an existing Earth Electrode with a low earth resistance, such as a metal water pipe, a common earth of a commercial power supply and an earth terminal of a building, can be used with the 2-Wire method. However, the measured earth resistances contain the auxiliary earth resistance and the resistance of the E Test Lead.

This instrument is supplied with a set of Simplified Measurement Test Leads (additional paid) for which both of Alligator Clips and Flat Test Bar can be replaced and used if necessary.

Terminals to be used: E, S(P), H(C) Terminals

Test Leads: one to the E Terminal, Simplified Measurement Probes to the S and H Terminals and short-circuit these Terminals.

Auxiliary Earth Spike: None is used

(1) Setting of Wiring System

Select Wire(2) with reference to 7-2-2 Setting for Measurement Method in this manual.

(2) Setting of R_k

1. Put the Alligator Clips to the 2 Test Leads (green, red), and connect the green Plug to the E Terminal and the two red Plugs to the S(P) and H(C) Terminals respectively.

2. Select the 2Ω or 20Ω Range.

3. Engage 2 Alligator clips to short-circuit both of them.

4. Save the R_k values with reference to 7-2-6 Setting for the residual resistance (R_k) on the Test Leads.

Note) A break in Test Leads or burnout of Fuse is suspected when the LCD show $R_k = OL \Omega$ while 4 Test Leads are being shorted.

(3) Connection (Reference To Fig. 24)

Connect the Test Leads as shown in Fig.24

Note) When the supplied Simplified Measurement Probes are not used, the S(P) and H(C) Terminals should be shorted.

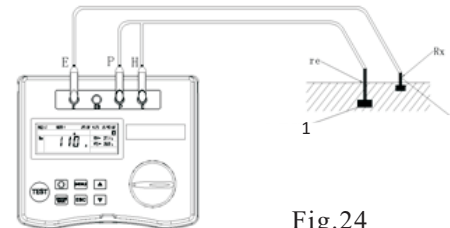

Fig.24

1. consider the low earth resistance as the auxiliary earth pole.

2. measured object connecting to earth.

(4) Earth Resistance Measurement

Select a high resistance Range when the connection is done, and press the TEST Button. Then the earth resistance values R_e are displayed on the LCD. Select a lower Range for the low earth resistances.

(5) Measured resistances at simplified measurements

Two-Wire method is used for the simplified measurements. In this method, earth resistance of the earthed electrode (r_e) connected to the S(P) Terminal is added to the true earth resistance R_x and shown as an indicated value R_e .

$$R_e (\text{indicated value}) = R_x + r_e$$

If the R_e is known beforehand, true earth resistance value R_x is calculated as follows.

$$R_x = R_e - r_e$$

Note) The R_e cannot be canceled by the setting of R_k .

(4) Earth Resistance Measurement

Select a Range (any Range is ok) when the connection is done, and press the TEST Button.

It is shown "Measuring..." when testing.

Measured earth resistance R_e are displayed on the LCD.

Press downarrow Key to display the results screen , and any information can be checked .

Press uparrow Key to the main screen .

Note) The readings may not correct when the auxiliary earth resistance is too high. Stick the Auxiliary Earth Spikes S(P) and H(C) in the moist part of the soil , and make sure the fully contact of all connected parts.

Note) If a message $R_h > \text{limit}$ or $R_s > \text{limit}$ appear on the LCD, auxiliary earth resistance is too high to make measurements. Recheck the connection of Test Leads. If it has to be measured at the dry place or that with much little stone , please water the point in which the auxiliary earth spikes are pressed . Be sure to keep it wet . While making the measurement on concrete, the auxiliary earth spikes flat flooding or use wet cloth into the auxiliary earth spikes for testing.

8-1-2 Precise Measurement (4-wire) with earth Test Leads

The ES terminal is also used with the other terminals used at the 3-wire Precise measurements. In this case, more precise results can be obtained because auxiliary earth resistances of the measured earth resistances are excluded , moreover, resistance of the Test Leads connected to the E Terminal can be canceled.

Terminals to be used: E, ES, S(P), H(C) Terminals Test Leads: Connect to the E, ES, S(P), H(C) Terminals (the ES Test Lead should be connected to the earthed equipment under test where the E Test Lead is connected)

Auxiliary Earth Spike: 2 pcs

(1) Setting of wiring System

Select Wire(4) with reference to 7-2-2 Setting for Measurement Method in the manual.

(2) Setting of R_k

The measured results obtained at 4-Wire system are not be influenced by the Test Leads Connected to the E Terminal, but setting of R_k can be made on this instrument.

1. Firmly insert each plug of 4 Test Leads (green, black, yellow, red), to the corresponding connectors on the instrument.

2. Select the 2Ω or 20Ω Range.

3. Engage 4 Alligator clips to short-circuit all of them.

4. Save the R_k values with reference to 7-2-6 Setting for the residual resistance (R_k) on the Test Leads.

Note) A break in Test Leads or burnout of Fuse is suspected when the LCD shows $R_k = OL \Omega$ while 4 Test Leads are being shorted.

(3) Connection of Auxiliary Earth Spikes and Test Leads (Reference To Fig. 23)

Stick the Auxiliary Earth Spikes S(P) and H(C) into the ground deeply. They should be aligned at an interval of 5-10m from the earthed equipment under test. Connect the green Test Lead to the earthed equipment under test, the yellow Test Lead to the Auxiliary Earth Spike S(P) and the red Test Lead to the Auxiliary Earth Spike H(C). The black Test Lead connected to the ES Terminal should be connected to the earthed equipment under test.

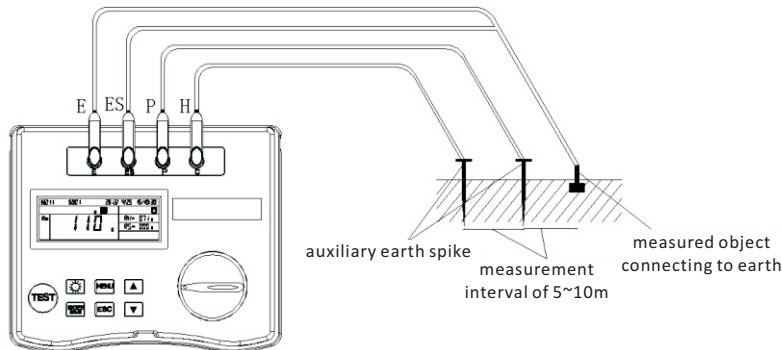

Fig.23

2. FEATURES

This instrument 2/ 3/ 4-Wire Digital Earth Resistance/ Earth Resistivity Tester equipped with a microcomputer and can measure earth resistances and calculate earth resistivities (ρ) It can also measure earth resistances on power distribution lines, in-house wiring system and electrical appliances etc. due to the low output voltage: approx 10Vrms or less.

· Designed to meet following safety standards.

IEC 61010-1 (CAT.III 300V, CAT.IV 150V, Pollution degree 2)

IEC 61010-031 (Requirements for hand-held Probes)

IEC 61557-1, 5 (Earth Resistance Tester)

· Stable measurement results can be obtained under a noisy environment by introducing the FFT (Fast Fourier Transform) technology.

· LCD display

· Backlight function to view the test results in dimly areas

· R_k Function is available to cancel the residual resistance on the Test Leads.

· Battery Check Function

· Auxiliary Earth Resistance Measurement Function

Auxiliary earth resistances are measured and displayed.

· Warning for Auxiliary Earth Resistance Measurements

Warnings are displayed on the LCD when auxiliary earth resistances are too high and may result in inaccurate measurements.

· Auto-Power-Off Function

The instrument is automatically powered off when 5 min passes without any Key operation.

· Data storage

Save 1000 test data

3. SPECIFICATIONS

IEC 61010-1 (CAT.III 300V, CAT.IV 150V, Pollution degree 2)

IEC 61010-031 (Requirements for hand-held Probes)

IEC 61557-1, 5 (Earth Resistance Tester)

IEC 61326-1 EMC Standard

Test range (temperature and humidity) $23 \pm 5^\circ C$ $45 \sim 75\% RH$

Function	Range	Resolution	Testing range	Accuracy
Earth resistance R_e (Earth resistance $\rho = R_g$)	2Ω	0.01Ω	$0.05 \sim 2.09 \Omega$	$\pm(3\%rdg.+5dgt)$ (Remarks 1)
	20Ω	0.1Ω	$0.5 \sim 20.9 \Omega$	
	200Ω	1Ω	$5 \sim 209 \Omega$	
	2000Ω	10Ω	$0.05 \sim 2.09 K\Omega$	
	$20k\Omega$	100Ω	$0.5 \sim 20.9 K\Omega$	
Auxiliary earth resistance R_h, R_s				$(R_e + R_h + R_s) 8\%$
Soil resistivity ρ (remarks 3)	2Ω		$0.3 \sim 393.7\Omega.m$	$\rho = 2 \times l \times a \times R_g$ (Remarks 2)
	20Ω		$3 \sim 3937\Omega.m$	
	200Ω		$0.03 \sim 39.37\Omega.m$	
	2000Ω		$0.3 \sim 393.7\Omega.m$	
	$20k\Omega$		$3 \sim 1999\Omega.m$	

(remarks 1) revised Auxiliary Earth Resistance $100\Omega R_k$.

(remarks 2) Depending on the test value of R_g . Between the auxiliary ground rods $[a]1.0 \sim 30.0m$

(remarks 3) Not available for voltage testing of commercial power.

- Ground resistance test methods
 - Voltage drop method (Probe current and voltage testing)
 - Test method of soil resistivity (ρ): 4-pole
 - Output: Test voltage U_m Max: 10Vrms 125Hz
 - Test current I_m Max: 80mA/ $I_m \times (R_e + R_h) < U_m$
 - Data save: 1000
 - LCD Display
 - Earth resistance: max 20.9k Ω
 - Earth resistivity : 1999k $\Omega \cdot m$
 - Low Battery Warning: Battery mark appears.
 - Continuous Measurement: 400 times or more with manganese batteries; repeating measurements at every 30 sec with a load of 1 Ω in the range 2 Ω
 - Over-range Indication :OL
 - Auto-Power-Off Function
- The instrument is automatically powered off when 5 min passes without any Key operation.
- Location for use: Indoor/ Outdoor use (Not completely waterproof), altitude 2000m or less
 - Applicable range: Testing earth resistance on power distribution lines, in-house wiring system and electrical appliances
 - Temperature & Humidity range (guaranteed accuracy) : 23 $^{\circ}C$ ation)
 - Temperature and humidity range: 0 $^{\circ}C$ ~ 40 $^{\circ}C$, relative humidity 85% or less (no condensation)
 - Operating Temperature & Humidity range :-10 $^{\circ}C$ ~ 50 $^{\circ}C$, relative humidity 75% or less (no condensation)
 - * Supplied Test leads cannot be used at 0 $^{\circ}C$ or less.
 - Storage Temperature & Humidity range :-20 $^{\circ}C$ ~ ~60 $^{\circ}C$, relative humidity 75% or less (no condensation)
 - Overload Protection : between E-S(P) and between E-H(C) terminals AC280V / 10 second it and enclosure AC3540V(50/60Hz) / 5 second
 - ircuit and enclosure 50M Ω or more / DC1000V
 - Dimension: 167 (L) x 185 (W) x 89 (D) mm
 - Weight: 900g(including batteries)
 - Power source: DC12v: size AA manganese dry battery((R6P)*8
 - **In a use of this instrument under low temperature below 0 $^{\circ}C$, a use of alkaline batteries with low temperature spec is recommended.
 - Operating error Operating error (B) from the error within the rated operating conditions, the use of machinery inherent errors (A and variable error (En) is calculated.

$$B = \pm \left(|A| + 1.15 \sqrt{E_2^2 + E_3^2 + E_4^2 + E_5^2} \right)$$

- A : Inherent error
- E2 : Changes by changes in supply voltage
- E3 : Changes by temperature changes
- E4 : Series interference voltage changes
- E5 : change by the resistance of auxiliary earth electrode

- Range to keep the maximum operating error
- Measurement range within which the maximum operating error ($\pm 30\%$) applies.
- 2 Ω Range: 0.5 Ω ~ 2.09 Ω
- 20 Ω Range: 2 Ω ~ 20.9 Ω
- 200 Ω Range: 20 Ω ~ 209 Ω
- 2000 Ω Range: 200 Ω ~ 2.09k Ω
- 20k Ω Range: 20k Ω ~ 20.9k Ω

7-4 Auto-Power-Off

This instrument is automatically powered off about in 5 min after the last switch operation. To exit from the auto-power-off mode, set the Range Switch to OFF position once, and re-set it to the Range at which a measurement to be conducted.

7-5 Auxiliary Earth Resistance Measurement

This instrument can measure and display the auxiliary earth resistances (R_h , R_s). When the R_h or R_s value is more than Regulated value or 50 Ω , a warning message $R_h > \text{limit}$ or $R_s > \text{limit}$ appear. The LCD shows $R_h = \text{OL}$ Ω or $R_s = \text{OL}$ Ω indicates values exceed 50k Ω . These parameters are measured automatically at auxiliary earth resistance measurements, and can be checked on the Result Display Screen.

Note) R_h and R_s stand for Auxiliary Earth Pole H(C) and the Auxiliary Earth Resistance of S(P) respectively.

7-6 Connection of Earth Test Leads and Simplified Measurement Probes

Connect the Earth Test Leads and Simplified Measurement Probes to the connectors on the instrument firmly. Otherwise, a contact failure occurs and wrong results may be read out on the LCD.

Note) Some numbers other than OL may be displayed on the LCD when making measurement without connecting any cord or probe at 200 Ω or upper Ranges. This is not a malfunction.

8. Measurement Method

8-1 Earth Resistance Measurement

8-1-1 Precise Measurement (3-Wire) with Earth Test Leads

This is a standard method to measure earth resistances. The measured earth resistances are free of auxiliary earth resistances but the resistances on the E terminal are contained.

Terminals to be used: E, S(P), H(C) Terminals

Test Leads: connect to the E, S(P), H(C) Terminals

Auxiliary Earth Spike: 2 pcs, connect to the S(P) and H(C) terminal

(1) Setting of Wiring System

Select Measurement (3-Wire) with reference to 7-2-2 Setting for Measurement Method in this manual.

(2) Setting of Rk

1. Firmly insert each plug of 3 test leads (green, yellow, red) to the corresponding connectors on the instrument.

2. Select the 2 Ω or 20 Ω Range.

3. Engage 3 Alligator clips to short-circuit all of them.

4. Save the Rk values with reference to 7-2-6 Setting for the residual resistance (Rk) on the Test Leads.

Note) A break in Test Leads or burnout off fuse is suspected when the LCD shows $R_k = \text{OL}$ Ω while 3 Test Leads are being shorted.

(3) Connection of Auxiliary Earth Spikes and Test Leads

Stick the Auxiliary Earth Spikes S(P) and H(C) into the ground deeply. They should be aligned at an interval of 5-10m from the earthed equipment under test. Connect the green Test Lead to the earthed equipment under test, the yellow Test Lead to the Auxiliary Earth Spike S(P) and the red Test Lead to the Auxiliary Earth Spike H(C) . The black Test Lead connected to the ES Terminal should be connected to the earthed equipment under test.(Fig. 22)

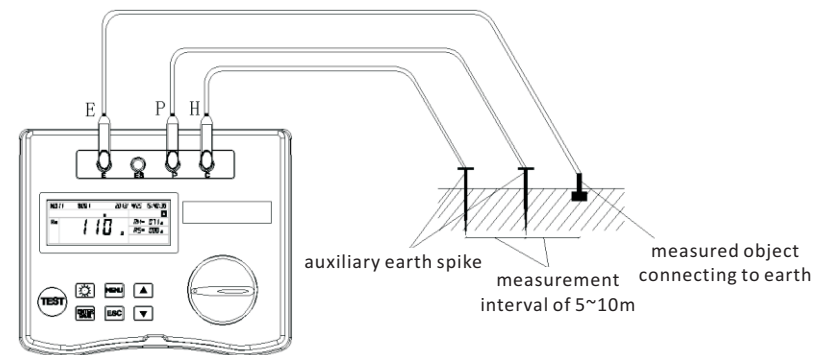

Fig.22

Press the ESC when settings are done to return to the Date Set ? (Fig.18) .
 Press the ESC Key again to exit from the setting mode and return to the CONFIG-SETTING Screen (Fig. 16) .
 Then the Date starts. Note) The backup battery may be exhausted when clock becomes wrong after powering on/off the instrument. In this case, please contact our local distributor. The life time of the backup battery is 2 years.

7-2-6 Setting for the residual resistance (Rk) on the Test Leads

This instrument can store the residual resistance (RK) of the Test Leads before starting measurements on 2/3/4-wire system, and can deduct the resistance from the measured result.

The setting of Rk can be done in following procedure.

Set the range to 2Ω or 20Ω. It can not be measured the residual resistance (RK) on the Test Leads on the other ranges . Select Rk Set ? (Fig. 19) with the arrow keys on the CONFIG_SETTING Screen, and press the ENTER/SAVE Key to display the Rk Setting Screen (Fig.20) .

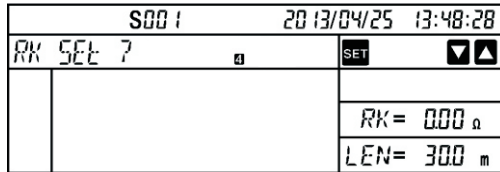

Fig.19

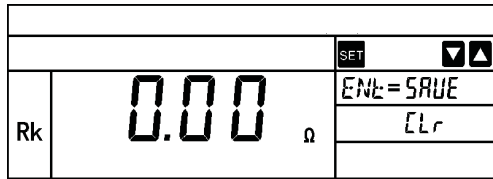

Fig.20

Connection of 4-Wire , 3-Wire or 2-Wire measurement are different, please see 8-1-1 ,8-1-2 or 8-1-3. Press the Test Button to measure Rk. The measured results will not be saved until the ENTER/SAVE is pressed. The CONFIG_SETTING Screen (Fig. 19) is displayed when the ESC is pressed down .

The Rk value is being kept even powering off the instrument. To clear the saved Rk values, select “Clr” on the Rk Setting Screen and press the ENTER/SAVE Key. Then the value restores to 0.00Ω. Then CONFIG_SETTING Screen (Fig. 19) is displayed again. Note)Rk values cannot be saved when a signal showing low power displays. Rk values exceeding following values cannot be saved : 2ΩRange: max 2Ω ; 2 0Ω Range: max 9Ω ; A message shown in Fig.21 is displayed when the measured Rk is exceeding above values.

The message shown in Fig.21 is also displayed when a fuse blows.

Following message appears and shows that the data cannot be saved when the ENTER/SAVE Key is

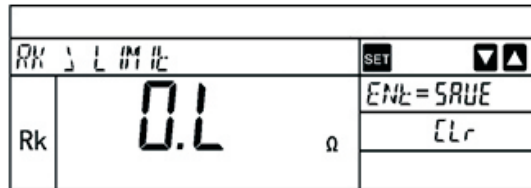

Fig.21

Following message “Rang > 20” appears on the 200Ω or upper Ranges , the value cannot be saved . But the Rk values saved at 2Ω and 20Ω Ranges are kept effective at 200Ω or upper Ranges.

Following message “2/3/4-W Only ” appears and shows that the data cannot be saved when trying to save Rk at Wire (ρ).

7-3 Backlight

To facilitate working in dimly-lit situations or in night time, a backlight function is provided which illuminates the LCD.

Press the backlight Key to operate this function. The backlight will light up for about 30 seconds and turned off automatically.

Press the backlight Key while the backlight is on can turn it off.

- Variation of Supply Voltage : until the Battery Warning mark appears
- Temperature Variation : -10℃ ~ 50℃
- Auxiliary earth electrode resistance : within following range or 50kΩ

Rh, Rs limit	
Re < 0.40 Ω	≤ 1k Ω
0.40 Ω ≤ Re < 1.00 Ω	≤ 2k Ω
1.00 Ω ≤ Re < 2.00 Ω	≤ 3.5k Ω
2.00 Ω ≤ Re	= Rex100+5k Ω (Rh, Rs < 50k Ω)

4. NAMES OF PARTS

- 1 LCD
- 2 TEST
- 3 Backlight
- 4 ENTER/SAVE
- 5 MENU
- 6 ESC
- 7 Cursor Key
- 8 Range power
- 9 E port
- 10 ES port
- 11 S port
- 12 H port

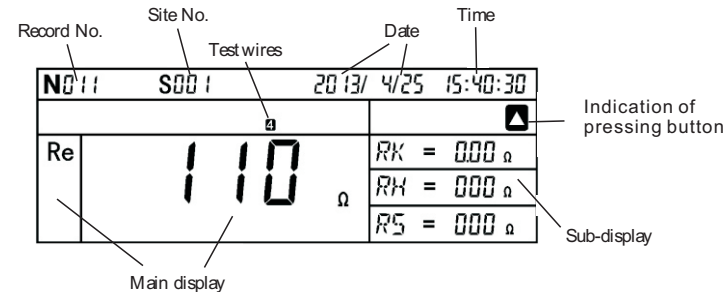
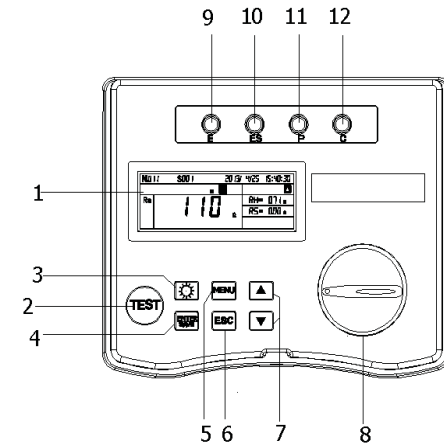

5. MARKS AND MESSAGE DISPLAYED ON THE LCD

Marks and Message	Details
BATT	Low Battery .
MEASURING...	The meter is under measurement.
OL	Over Range.
---	Can not measure.
RK > LIMIT	Rk exceeds limit .
RANGE 1 20	Setting for Rk can be made at 20Ω
2/3/4-W ONLY	Setting for Rk can be made only at 2w,3w,4w measurements.
RH > LIMIT RS > LIMIT	Rh and rs values exceed the allowable range. Correct results might not be obtained.
MEM EMPTY	No saved data exists.
MEMORY FULL	Memory is full. No more data can be saved.
DEL ONE ITEM?	A confirmation message before deleting the selected.
DEL ALL ITEM?	A confirmation message before deleting all selected.
DELETE SUCCEEDED	All items have been deleted.
NO 11/ 105	Nxxx is a memory no., and the left message saying 105 data have been stored. (Displayed at the Data Review Screen.)
NO 11	Indicating the measured result is saved with Memory NO. 011.
S001	The character S stands for Site. Selectable from 000 to 999.
SAVE DATE SUCC	Data is successfully saved.

6. MEASUREMENT PRINCIPLE

6-1 Principle of Earth Resistance Measurements

This instrument makes earth resistance measurement with fall-of-potential method, which is a method to obtain earth resistance value R_x by applying AC constant current I between the measurement object E (earth electrode) and $H(C)$ (current electrode), and finding out the potential difference V between E (earth electrode) and $S(P)$ (potential electrode) See Fig.1.

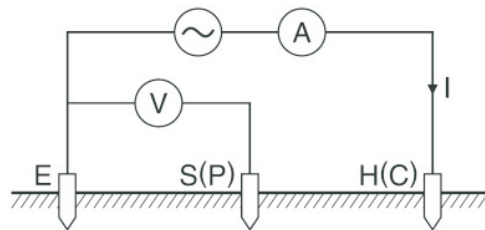

$$R_x = V/I$$

Fig.1

Press the up cursor Key to increase number and the down Cursor Key to reduce numbers.

Press the ENTER/SAVE key when the suitable number is shown . Then return to the Length Setting screen (Fig. 14) .

Repeat this procedure to change the other digits. Press the ESC Key when settings are done. Then the CONFIG-SETTING Screen with a new interval will be displayed (Fig. 13) . And the setting value will be seen followed by item LEN in the vice display area.

Note) Intervals can be set within a range of 1.0 to 30.0m. If "39.9m" is shown in the Setting Screen, it will be changed to 30.0m when pressing the ENTER/SAVE key.

7-2-5 Date and Time Setting

This instrument has a clock function and can save the measured data with time and date information. The clock will not be reset once it has been set even after powering off the instrument. A manual adjustment is required to keep the clock time always right. Time setting can be done in following procedure. Select Date/Time Set ? (Fig. 16) with the Cursor Key on the CONFIG-SETTING Screen, and press the ENTER/SAVE Key to display the Time (Fig. 17) and Date (Fig. 18) Setting Screen.

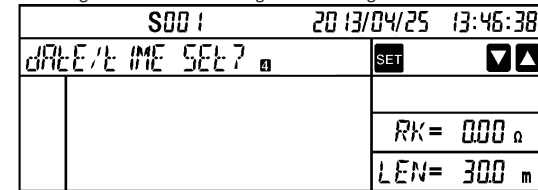

Fig.16

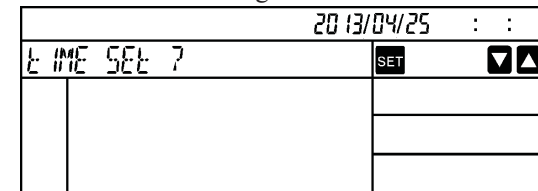

Fig.17

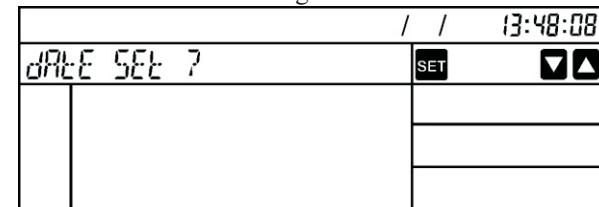

Fig.18

(1) Time Setting (24-hour display) Press the arrow keys to Time Set ? (Fig. 17) and the time number in the LCD is flashing. Press the ENTER/SAVE Key, and display the time Setting Screen.

Press the arrow keys to select Hour Set ? / Minute Set ? / Second Set ? .

Press the ENTER/SAVE Key to display the screen in which the digits to be adjusted , and the selected digits is flashing. Put the up-arrow key to increase numbers and the down-arrow key to reduce numbers. Press the ENTER/SAVE Key to confirm the available number shown in the LCD , then skip to the next selection . Repeat this procedure to change the other digits.

Press the ESC when settings are done to return to the Time Set ? (Fig. 17) .

Press the ESC Key again to exit from the setting mode and return to the CONFIG-SETTING Screen (Fig. 16) . Then the clock starts.

(2) Date Setting Date is displayed in the following order: Year/ Month/ Day.

Press the arrow keys to Date Set ? (Fig. 18) and the date number in the LCD is flashing.

Press the ENTER/SAVE Key, and display the date Setting Screen.

Press the arrow keys to select Year Set ? / Month Set ? / Day Set ? .

Press the ENTER/SAVE Key to display the screen in which the digits to be adjusted , and the selected digits is flashing. Put the up-arrow key to increase numbers and the down-arrow key to reduce numbers. Press the ENTER/SAVE Key to confirm the available number shown in the LCD , then skip to the next selection . Repeat this procedure to change the other digits.

Select the setting digit with the Cursor Key , and the selected digit is flashing. Then press ENTER/SAVE key to stop flashing to enter selected digit screen (Fig. 12) . It can be changed with the CursorKey right now .

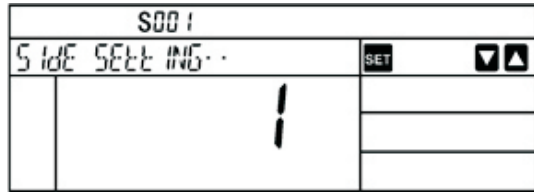

Fig.12

Press the up cursor Key to increase number and the down Cursor Key to reduce numbers.Press the ENTER/SAVE key when the suitable number is shown . Then return to the Site Setting screen (Fig. 11) . Repeat this procedure to set the next digits. After all settings are done , press the ESC key to return the Fig. 10 on the CONFIG SETTING mode . The saved number on the LCD represents the set site number .

7-2-4 Setting for the interval between Auxiliary Earth Spikes at Earth Resistivity (Ω)
 Making setting of the intervals between auxiliary earth spikes is necessary to measure earth resistivity .

The setting order is as follows .

Select Length Set ? (Fig. 13) with the Cursor Key on the CONFIG-SETTING Screen, and press the ENTER/SAVE key to display the Length Setting Screen (Fig. 14) .

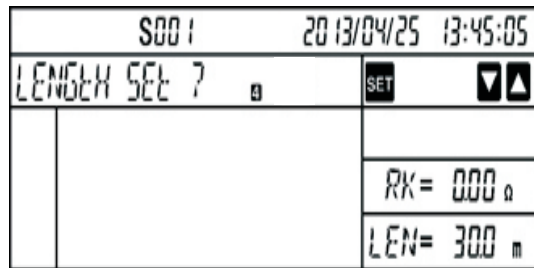

Fig.13



Fig.14

Select the setting digit with the Cursor Key , and the selected digit is flashing. Then press ENTER/SAVE key to stop flashing to enter selected digit screen (Fig. 15) . It can be changed with the CursorKey right now .

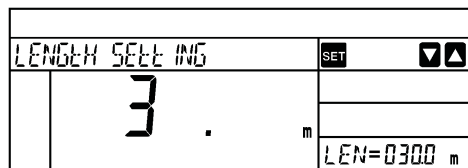

Fig.15

6-2 Principle of Earth Resistivity

According to the Wenner 4-pole method, apply AC current I between the E (earth electrode) and H(C) (current electrode) to find out the potential difference V between the potential electrode S(P) and auxiliary earth electrodes ES.

To Obtain the earth resistance “ $R_g (\Omega)$ ” where the interval between electrodes is a(m). Then use a formula: $\rho=2\pi aR_g(m\Omega)$

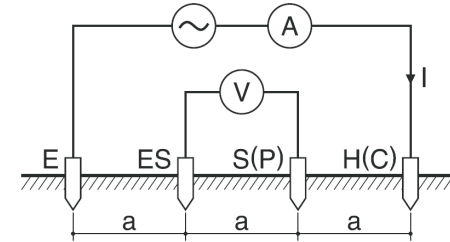

Fig.2

7. PREPARATION FOR MEASUREMENT

7-1 Battery Voltage Check

Power on the instrument. If the display is clear without the Low battery mark "LOW-B" showing, battery voltage is sufficient. Measurements cannot be made, even the Test Button is pressed, while the Low Battery Mark is displayed on the LCD. Measurements are fault when the Low Battery Mark appears on the LCD.

7-2 Test parameter setting

7-2-1 Setting Items

This instrument starts with Measurement mode (Fig.3 Main Screen) when it is powered on while the Range Switch has been set to the position other than OFF.

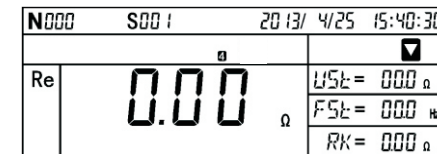

Fig.3

Measurement conditions should be set before starting measurements. Setting the date and time enables a saving measured data with time information .Press the MENU Key and enter into the SYSTEM_MENU.(Fig.4)

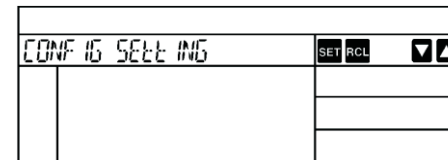

Fig.4

In the Fig.4 the flashing “SET” indicates it is the option for setting function, and press the ENTER/SAVE Key to enter into the CONFIG_SETTING mode. (Fig.5)

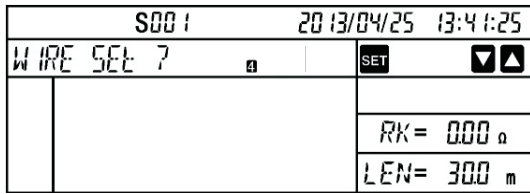

Fig.5

In the Fig.4 pressing the \square and \triangle can skip to the Fig.6 in which "RCL" keeps flash. That means it is the option to look back the records. And pressing "ENTRE/SAVE" can look back the saved data.

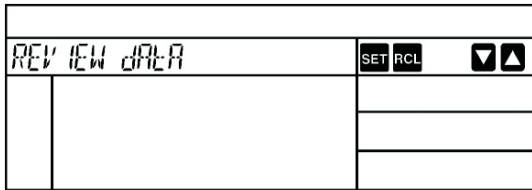

Fig.6

After all the settings have been finished, press the ESC Key twice to exit from the CONFIG-SETTING mode and return to Measurement mode.

Settings of following parameters can be made on this instrument

Wire: Measurement method (Wiring System)

Freq: Measurement frequency

Site: Site (location) No

Lh: Interval of the auxiliary earth spikes at Earth resistivity (ρ) measurement

Date/Time: Year/ Month/ Day, Time (24-hour display)

Rk : Residual resistance on the Test Leads

7-2-2 Setting for Measurement Method

Measurement method is selectable from: 2-wire (2-wire system), 3-wire (3-wire system), 4-wire (4-wire system) and (earth resistivity).

Select Wire with the Cursor Key on the CONFIG_SETTING Screen and press the ENTER/SAVE Key to proceed to the Wiring Setting Screen Fig.7

Select the appropriate Wiring System with the Cursor Key and the undetermined selection is in the flash condition Fig.8.

Press the ENTER/SAVE Key. to return the CONFIG_SETTING Screen with the selected Wiring System will be displayed Fig.9 The confirmable measurement method can be seen at the place where display the selected wiring system.

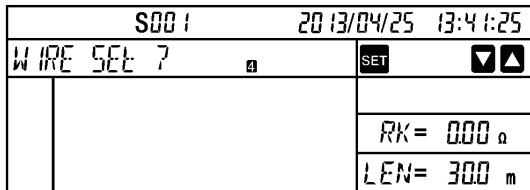

Fig.7

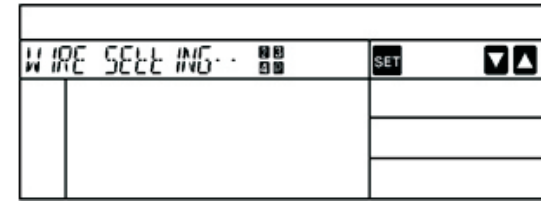

Fig.8

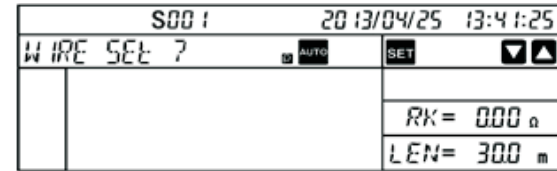

Fig.9

7-2-3 Site (location) no. setting

The site (location) where measurements done can be saved with numbers from 000~999 .

Select Site Set ? (Fig. 10) with the Cursor Key on the CONFIG SETTING screen, and press the ENTER/SAVE key to enter the Site Setting screen (Fig. 11) .

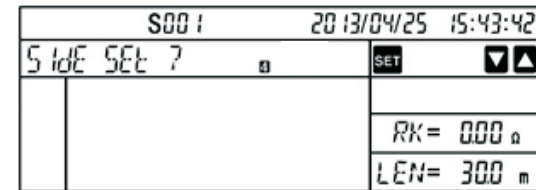

Fig.10



Fig.11