



SPECIFICATION FOR APPROVAL

TO : _____

REF. No. _____

<p>APPROVED DATE</p> 	<p>CHECKED DATE</p> 	<p>PREPARED DATE</p> 
---	--	---

MODEL No. AD0624HB-A76GL P.S. (T)

DESCRIPTION: DC FAN REV. A

ID No. _____

THIS OFFER IS MADE ACCORDING TO YOUR CURRENT INQUIRY.
UNLESS OTHERWISE REVISED, THIS SPECIFICATION WILL BE FINAL FOR
ALL FUTURE PRODUCTION OF ORDERS FROM YOUR RESPECTED COMPANY

KINDLY STUDY IN DETAILS AND RETURN TO US THE DUPLICATE DULLY
SIGNED AS YOUR CONFIRMATION OF SAME.



ADDA CORPORATION



BRUSHLESS AXIAL COOLING FANS

Customer :		Ref:
Adda Model No. :	AD0624HB-A76GL	P.S:(T)
Samples attached : 0 piece(s),		
Safety Approval : CE		
Specifications =====		
ITEM	SPECIFICATION / CONDITION	
DIMENSIONS	:	60x60x25 MM
BEARING TYPE	:	BALL
RATED VOLTAGE	:	24.0 VDC
OPERATING VOLTAGE RANGE	:	21.6 VDC - 26.4 VDC
START-UP VOLTAGE	:	17.0 VDC, NOMINAL
RATED CURRENT	:	0.150 Amp. + 10% MAX
RATED POWER	:	3.60 Watt.
RATED SPEED	:	4500 RPM \pm 10% (IN FREE AIR AT RATED VOLTAGE)
AIR FLOW	:	23.2 CFM (IN FREE AIR AT RATED VOLTAGE)
STATIC AIR PRESSURE	:	0.188 Inch Water (IN FREE AIR AT RATED VOLTAGE)
NOISE LEVEL	:	32.3 dB
MOTOR PROTECTION	:	BY IMPEDANCE
CONNECTION LEAD TYPE	:	WIRE, AWG#24
LIFE EXPECTANCY	:	50000 Hours at 25°C /65%
NET WEIGHT	:	68 Gram.
PACKING	:	300 pcs. per Export Carton.
MEASUREING CONDITION IS 25°C, 65% FOR ABOVE ITEMS.		
ADDA CORPORATION	Model No.:AD0624HB-A76GL	P.S:(T)
		 Page 1/4

SPECIFICATION

1.0 SCOPE

This documentation defines the mechanical & electrical Characteristics of DC Brushless Fans.

2.0 MATERIAL

2.1 Housing : UL94V-0 Glass Filled polyester (P.B.T)

2.2 Fan Blade : UL94V-0 Glass Filled polyester (P.B.T)

2.3 Bearing Sys. : () Sleeve, oil impregnated.
(V) Two Ball Bearing
() One Ball one Sleeve
() Hypro Bearing

3.0 DIMENSIONS & CONSTRUCTION

All dimensions, Direction of rotation and air flow were specified as per drawing attached.

4.0 CHARACTERISTICS & DEFINITION

4.1 All rated characteristics were specified as per data sheet enclosed.

4.2 Rated Current : Rated Current shall be measured after 3 minutes of continuous rotation at rated voltage.

4.3 Rated Speed : Rated Speed shall be measured after 3 minutes of continuous rotation at rated voltage.

4.4 Start Voltage : The voltage which is able to start the fan to operate by suddenly switching 'ON'.

4.5 Input Power : Input Power shall be measured after 3 minutes of continuous rotation at rated voltage.

4.6 Locked Rotor Current : Locked current shall be measured within one minute of rotor locked, after 3 minutes of continuous rotation at rated voltage in clean air.

4.7 Air Flow & Static Pressure : The air flow data and static pressures should be determined in accordance with AMCA standard or DIN24163 specification in a doublechamber testing with intake - side measurement.

4.8 Noise Level : The measurement of noise level is carried out with reference to CNS8753 in an echoic chamber with the microphone positioned 1 meter from the air intake. Testing fan shall be hung in clean air.

NOISE LEVEL MEASUREMENT

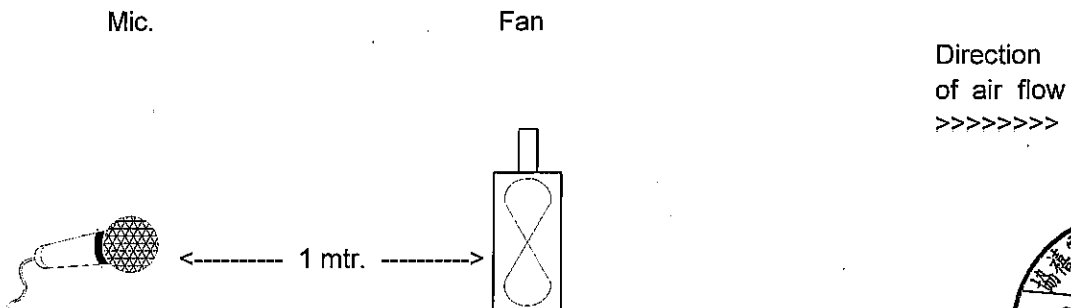

SPECIFICATION

5.0 MECHANICAL INSPECTION

5.1 Rotation Direction

Clockwise with label side facing up. The same direction also indicated by an arrow mark on one side of the housing.

5.2 Protection

All fans have integrated protection against locked rotor condition so that there will be no damage to winding or any electronic component.

Restarting is automatic as soon as any constraint to rotation has been released.

As fan placed at dead angle position, and the switch was changed from off to on. Restarting was automatic normal as soon as and proved that this fan is good fan.

5.3 Locked Rotor Protection

No damage shall be found after 72 hours continuously at condition of rotation locked.

Restarting is automatic as soon as constraint to running has been released.

5.4 Avoid the damage, check the correct voltage and proper polarity before connecting with power.

5.5 Free Drop Shock

In minimum package condition, the fan should withstand drops on any three faces from a height of 30cm onto a wood board of 10mm thick.

5.6 Please do not stick a grease and/or an oil to the fan housing or blade which may have a harmful influence by a chemical reaction at high humidity.

6.0 ELECTRICAL INSPECTION

6.1 Insulation Resistance

Not less than 10M ohm between housing and positive end of lead wire (red) at 500V DC.

6.2 Dielectric Strength

No damage should be found at 1,500 VAC for 60 seconds, measured with 5mA trip current between housing and positive end of lead wire.

6.3 Life Expectancy

The continuous duty life at given temperature after which, 90% of testing units shall still be running.

7.0 ENVIRONMENTAL

7.1 Operating Temperature / Humidity

-10°C to +70 at humidity 65%+/-20% RH.

7.2 Storage Temperature

All function shall be normal after 500 hours storage at -40°C to +70 °C with a 24 hour recovery period at room temperature.

7.3 Humidity

After 96 hours, 95% RH, 40+/-2°C per MIL-STD-202F, method 103B humidity test, the measured data on insulation resistance and dielectric strength shall meet the specification.



SPECIFICATION

8.0 REMARKS

- 8.1 Material and construction are subject to change without advance notice. The changes should be within specification.
- 8.2 All fans shall meet the quality inspection under sampling plan MIL-STD-105D as follow:

Critical	0.25%
Major	1.00%
Minor	2.50%

9.0 OUTLINE STYLING & DIMENSIONS

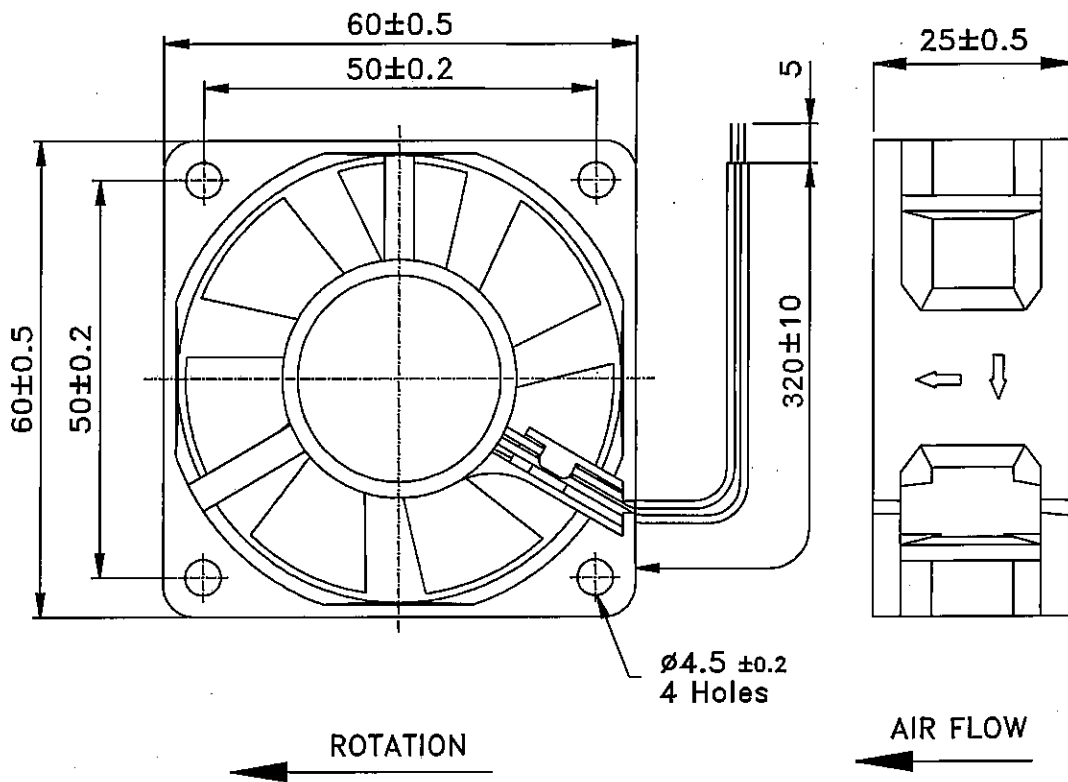

please do not touch and push Fan Blade with fingers or others.
 Fan Blade and Ball Bearings may be damaged.
 And it causes noise defect.

LEAD WIRES : UL 1007, AWG24 , L = 320 +/- 10 MM
 Red = positive ; Black = negative.



FG-6A

Output of locked signal

* Output type.....Open collector type

* Electrical specification

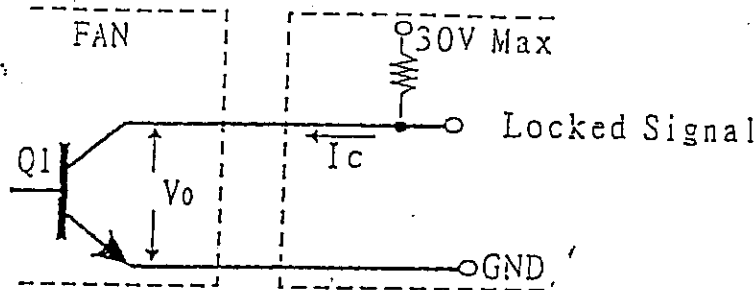

* Transistor Q1 at "ON" position

Collector current $I_c = 10\text{mA Max}$
 Saturation Voltage $V_{OL} = 1.0\text{V Max}$
 (Between Collector and Emitter at $I_c=10\text{mA}$)

* Transistor Q1 at "OFF" position

* Release Voltage..... $V_{OH} = 30\text{V Max}$

* Output waveform

