

Cam switches



10	Cam operated switches
11	General characteristics
12	Reference system
13	Technical data
14	Dimensions
18	Auxiliary contacts
19	Mounting possibilities
20	Mounting schemes
22	Special mountings
25	Accessories
31	Enclosures
32	Standard electrical schemes
46	Special diagrams
48	Main switches with undervoltage release
50	Discrepancy switches



Cam operated switches

A5 cam operated switches have been designed to operate as switch-disconnectors, main switches, load break switches, changeover switches, motor control switches,...

According to Standards

- IEC 60947-3
- UL 508

General characteristics

- Permits any electrical diagrams and makes the number of possible diagrams limitless.
- Abrupt breaking mechanism with 30, 45, 60 or 90° positions, according to diagram and requirements.
- Contact decks made of self-extinguishing polyester reinforced with glass fiber.
- Silver alloy low resistance contacts with high arcing and welding characteristics.
- Connection with protected cable clamps until 125A.
- Electrolytic treatment against oxidation of their ferrous components.
- High number of mechanical operations.
- According to RoHS standard.

General characteristics

Internal and external links

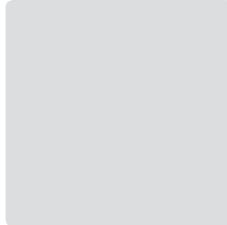

Simple "click" front plate fixing

Front plate designed for easy fixing by simple push-in on the mounting plate

Metallic shaft

Optimal mechanical effort transmission on the operating cams based on the use of strong metallic shaft. V shape position indication



Marking

Product marked with permanent ink indicating reference and electrical characteristics



Insert bolts

Bolts inserted on the breaking mechanism making simple switch mounting, saving time and avoiding loose components



Clamp-yoke connection

Contact surfaces grooved for optimal grip and conductivity

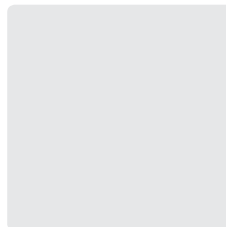
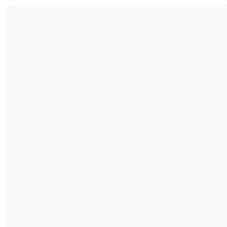

Protection degree IP20

Terminals protected against solid objects up to 12,5mm according to IEC 60529

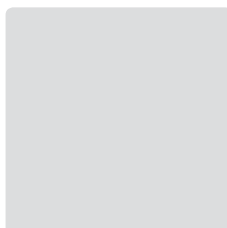

Plus/Minus Z screws

Reliability and maximum tightening torque using Z bits

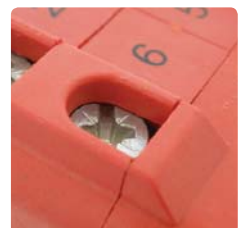



Reference system

Cam switches technology is typically defined by its large production flexibility permitting special solutions to multiple specific requirements that we find in the industrial world. These requirements are characterised by a variety of electrical schemes, large number of mounting possibilities and an assortment of

accessories. Referencing tailor made solutions is determined by production units and will generate a constructive file permitting lifelong tracking and future duplicates. Most common products can be ordered by standardised references as detailed on the following reference system description.

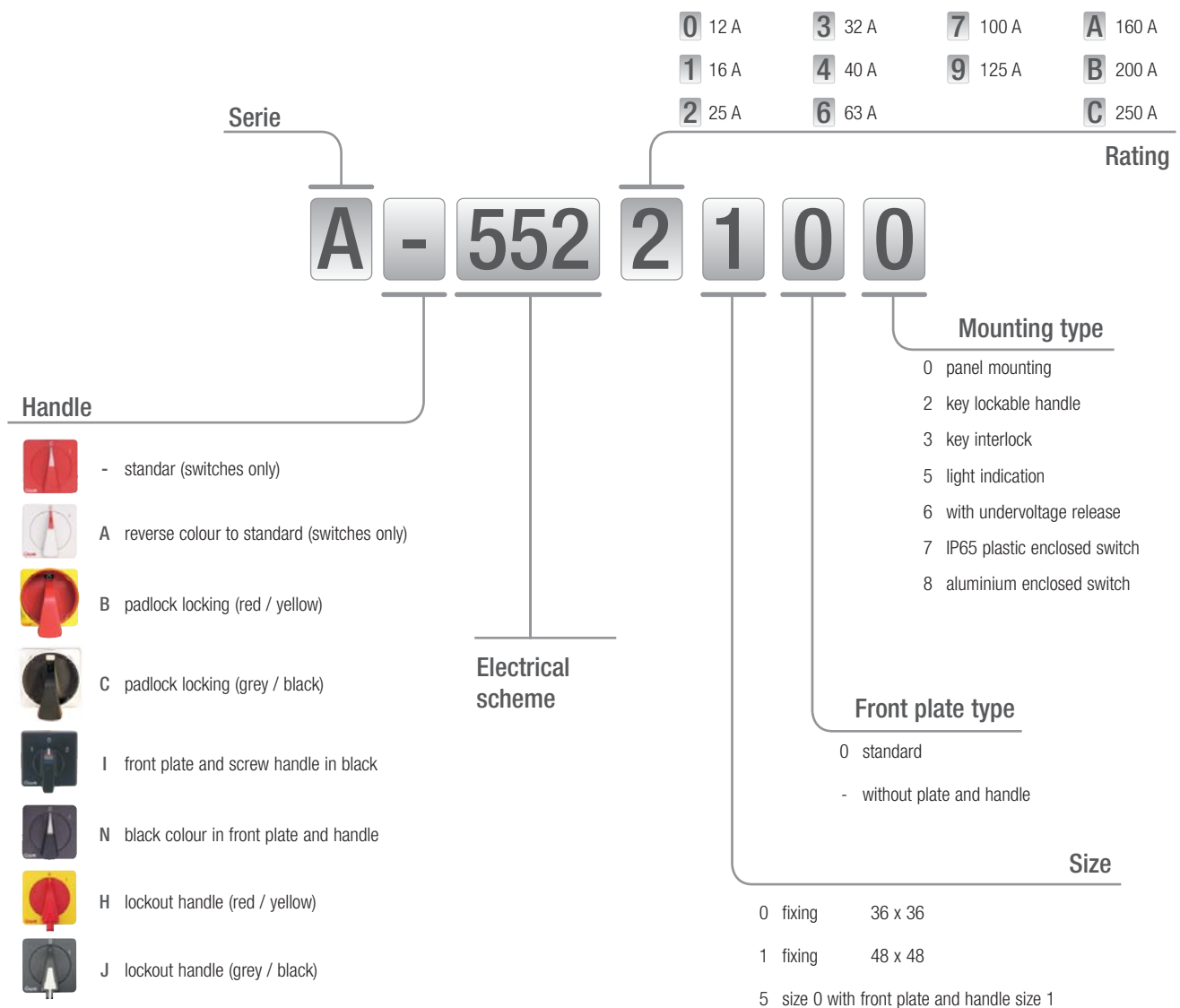

Technical data



		size 0					size 1						
		12A	16A	25A	25A	32A	40A	63A	100A	125A	160A	200A	250A
thermal rating	Ith A	16	20	30	32	40	50	70	100	125	160	200	250
max. fuse protection (gG-aM)	In A	20	25	25	32	40	50	80	125	125	200	200	250
impulse voltage	Uimp KV	4	4	4	4	4	4	4	4	4	4	4	4
conditional shortcircuit current	Icc KA	6	6	6	6	6	6	8	8	8	-	-	-
operating voltage	Ue V~	690	690	690	690	690	690	690	690	690	690	690	690
insulating voltage	V~	690	690	690	690	690	690	690	690	690	690	690	690
insulating voltage	V...	400	400	400	600	600	600	600	600	600	600	600	600
operational rating	Ie A	12	16	25	25	32	40	63	100	125	160	200	250
wire section													
	stranded mm2	2,5 - 6	2,5 - 6	2,5 - 6	10 - 25	10 - 25	10 - 25	16 - 50	16 - 50	16 - 50	70	95	120
	flexible mm2	2,5 - 6	2,5 - 6	2,5 - 6	10 - 16	10 - 16	10 - 16	16 - 50	16 - 50	16 - 50	70	95	120
	AWG	10	10	10	6	6	6	6 - 1	6 - 1	6 - 1	00	000	250 kcmil
torque	Nm	1,6	1,6	1,6	2	2	2	3,5	3,5	3,5	6	6	6
connection screws		M4	M4	M4	M5	M5	M5	M8	M8	M8	M8	M8	M8
terminal													
AC 21	kW 3 x 230V	3	5,5	7,5	11	11	15	22	37	37	45	55	75
	dummy kW 3 x 400V	7,5	11	15	18,5	18,5	22	37	55	75	90	110	132
	cosØ >0,95 kW 3 x 500V	11	15	18,5	22	22	30	45	75	90	110	132	160
AC 22	kW 3 x 230V	2,2	4	7,5	7,5	7,5	11	22	30	30	37	45	55
	mixed load kW 3 x 400V	5,5	7,5	11	15	15	22	30	45	55	75	90	110
	0,65 <cosØ <0,95 kW 3 x 500V	7,5	11	15	18,5	18,5	22	37	55	75	90	110	132
AC 23	kW 3 x 230V	2,2	3	4	4,5	5,5	7,5	15	18,5	18,5	30	38	-
	motor load VA kW 3 x 400V	4	5,5	7,5	10	11	18,5	22	30	37	52	65	-
	0,45 <cosØ <0,65 kW 3 x 500V	5,5	7,5	11	12	15	22	30	37	45	65	80	-
AC 11	VA 3 x 110V	600	1000	1400	2000	2000	-	-	-	-	-	-	-
	circuit loads VA 3 x 230V	1200	2000	2800	4000	4000	-	-	-	-	-	-	-
	magnetic VA 3 x 430V	2000	3500	4800	7000	7000	-	-	-	-	-	-	-
UL 508	1-phase 110-120V	hp	1	1,5	2	1,5	2	2	5	10	10	-	-
	1-phase 220-240V	hp	1,5	2	3	3	3	5	10	15	15	-	-
	3-phase 220-240V	hp	1	2	2	5	7,5	7,5	15	25	25	-	-
manual motor controller	3-phase 380-415V	hp	2	2	3	7,5	10	10	25	30	30	-	-
	3-phase 440-480V	hp	3	3	5	10	10	15	30	40	40	-	-
	3-phase 550-600V	hp	3	5	7	10	15	20	32	50	50	-	-

Dimensions standard connection

12A - 16A - 25A

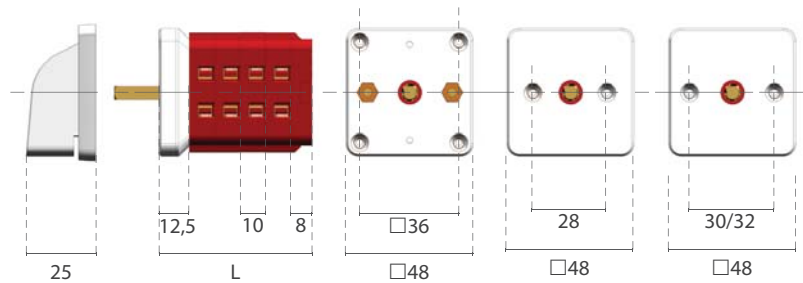

cells	1	2	3	4	5	6	7	8	9	10	11	12
length (L)	30,5	40,5	50,5	60,5	70,5	80,5	90,5	100,5	110,5	120,5	130,5	140,5

32A - 40A

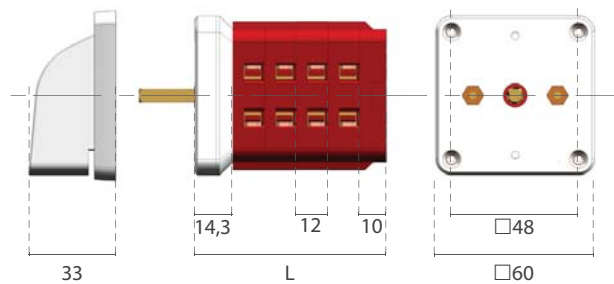

cells	1	2	3	4	5	6	7	8	9	10	11	12
length (L)	36,3	48,3	60,3	72,3	84,3	96,3	108,3	120,3	132,3	144,3	156,3	168,3

63A - 100A - 125A

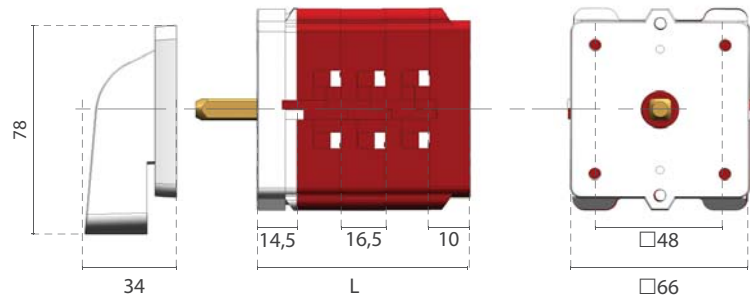

cells	1	2	3	4	5	6	7	8	9	10
length (L)	46,0	62,5	79,0	95,5	112,0	128,5	145,0	161,5	178,0	194,5

* lever handle on 100-125A switches

160A - 200A - 250A

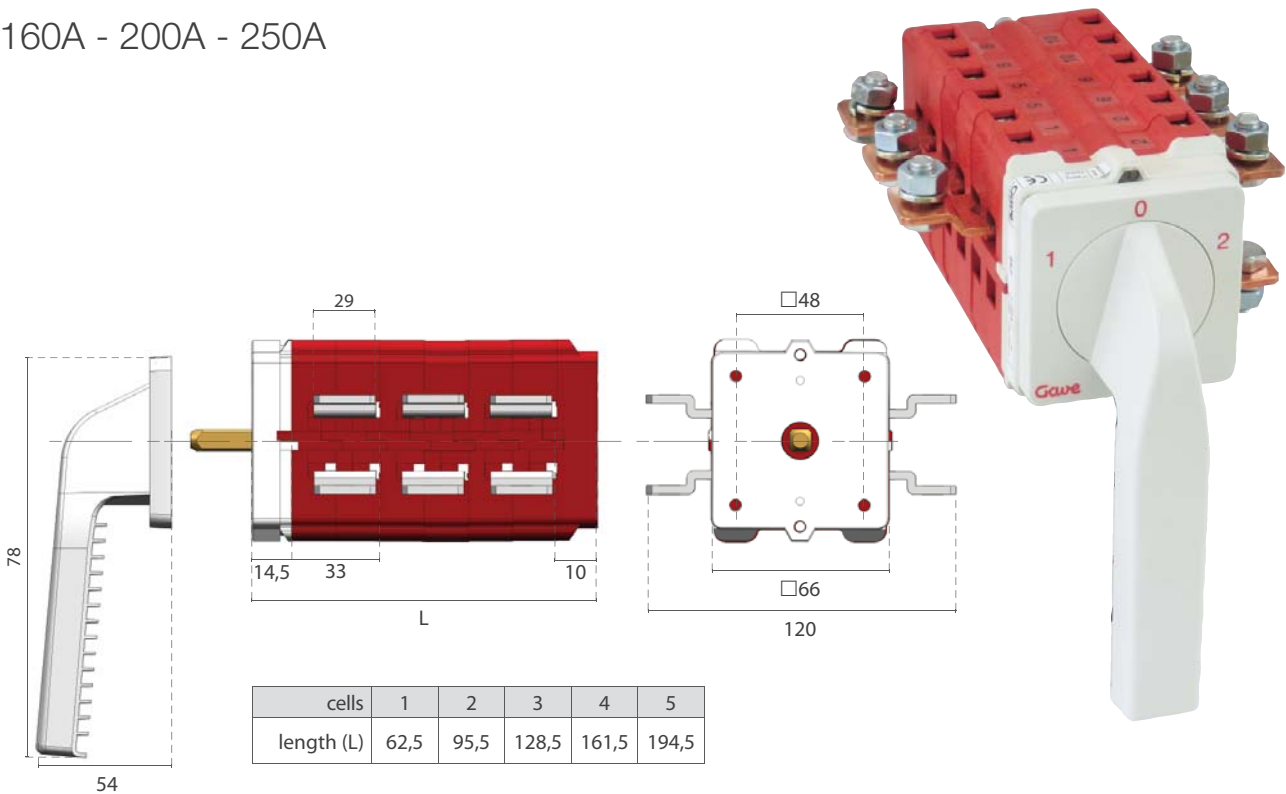

cells	1	2	3	4	5
length (L)	62,5	95,5	128,5	161,5	194,5

Dimensions lateral connection

12A - 16A - 25A

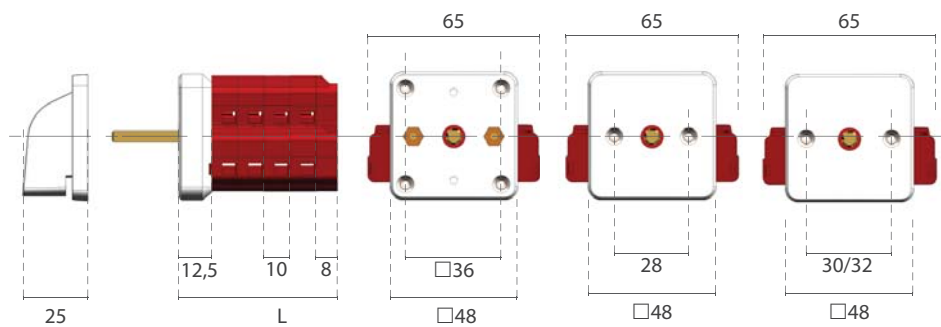

cells	1	2	3	4	5	6	7	8	9	10	11	12
length (L)	30,5	40,5	50,5	60,5	70,5	80,5	90,5	100,5	110,5	120,5	130,5	140,5

32A - 40A

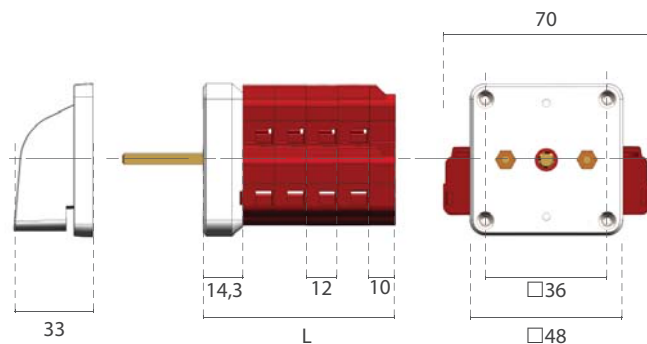

cells	1	2	3	4	5	6	7	8	9	10	11	12
length (L)	36,3	48,3	60,3	72,3	84,3	96,3	108,3	120,3	132,3	144,3	156,3	168,3

63A - 100A - 125A

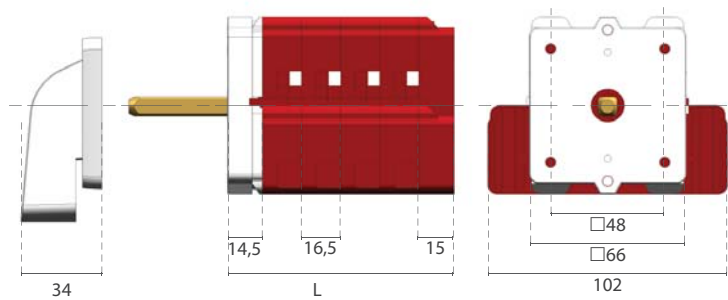

cells	1	2	3	4	5	6	7	8	9	10
length (L)	46,0	62,5	79,0	95,5	112,0	128,5	145,0	161,5	178,0	194,5

160A - 200A - 250A

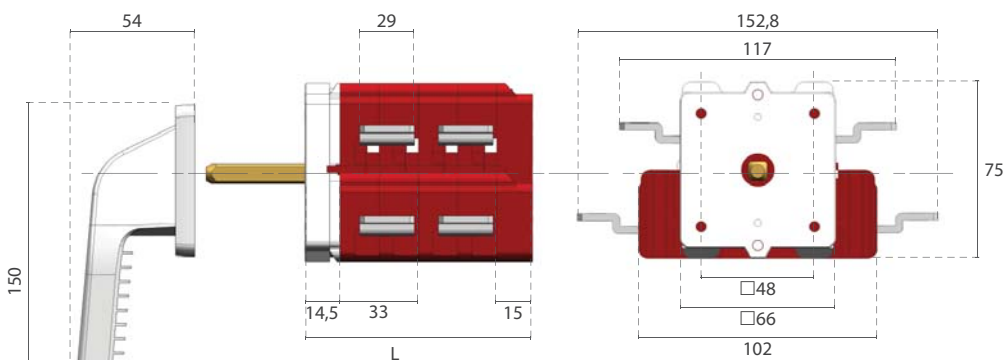
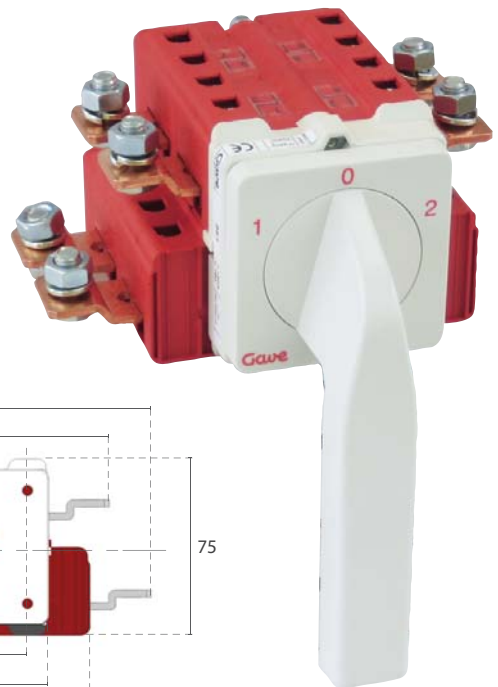

cells	1	2	3	4	5
length (L)	62,5	95,5	128,5	161,5	194,5

Auxiliary contacts



General characteristics

- On 55x, 56x and 57x electrical references
- Auxiliary contact 12A
- Mounted on independent cells

Reference system

The first digit on the electrical scheme is exchanged by a letter indicating the auxiliary contact type.

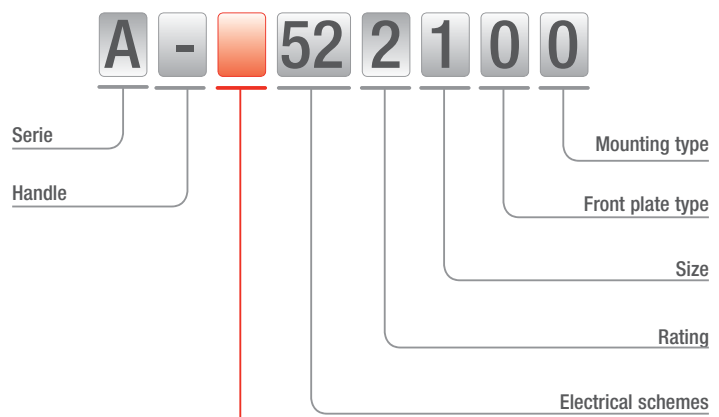

Auxiliary contacts:

- A 1 simultaneous auxiliary contact (close at the same time with main contacts)
- B 1 early make / late break auxiliary contact (close before main contacts)
- C 1 early break / late make auxiliary contact (open before main contacts)
- D 2 simultaneous auxiliary contacts (close at the same time with main contacts)
- E 2 early make / late break auxiliary contact (close before main contacts)
- F 2 early break / late make auxiliary contact (open before main contacts)
- G 2 simultaneous auxiliary contacts 1NO+1NC (only on-off switches)
- H 4 simultaneous auxiliary contacts (close at the same time with main contacts)

Dimensions

Size 1

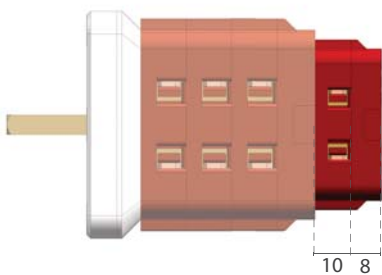

Size 2

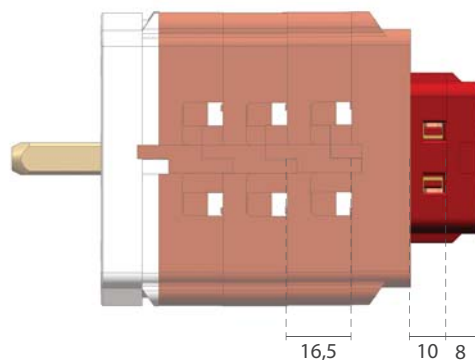

Mounting possibilities

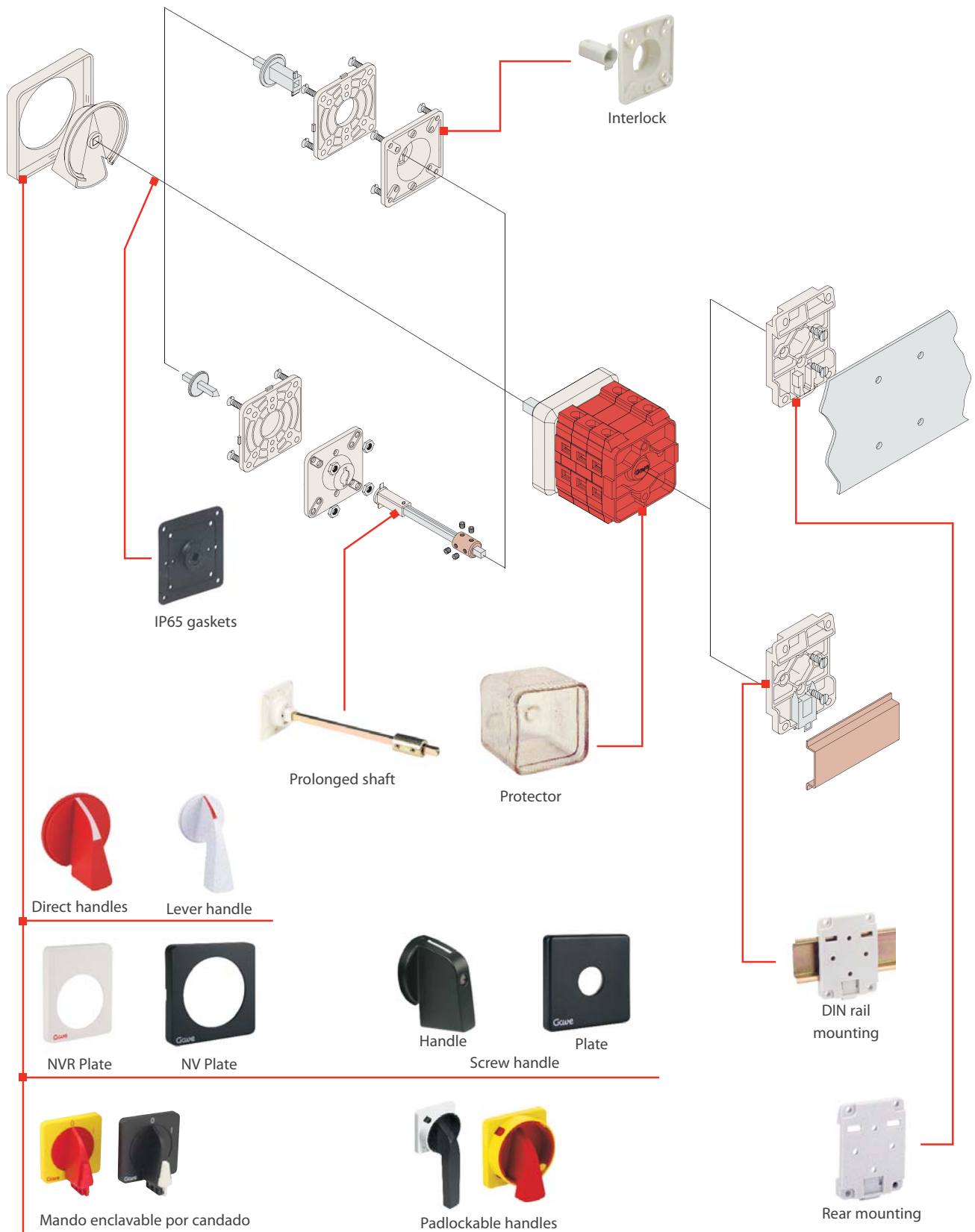

Mounting schemes

Direct mounting

frontal mounting

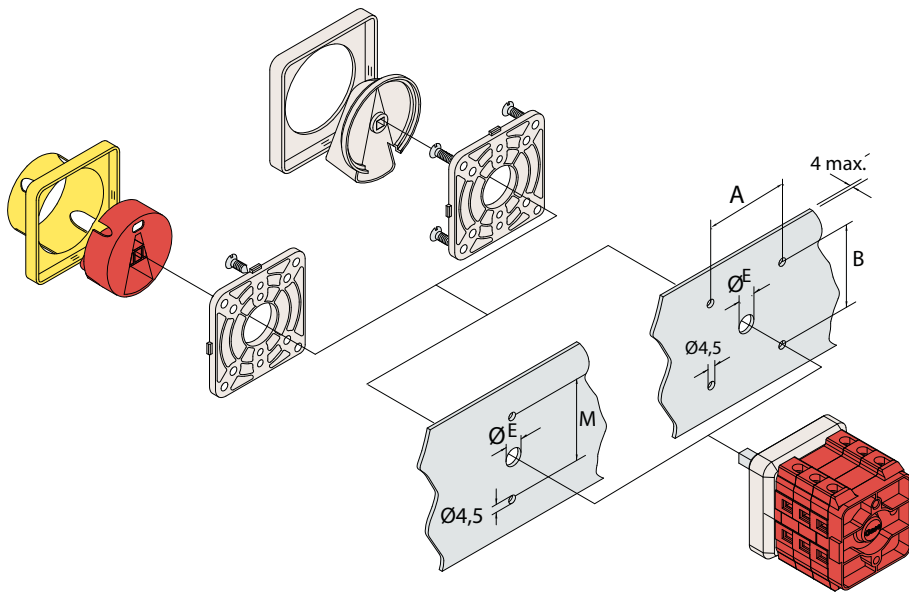

DIN rail or rear mounting

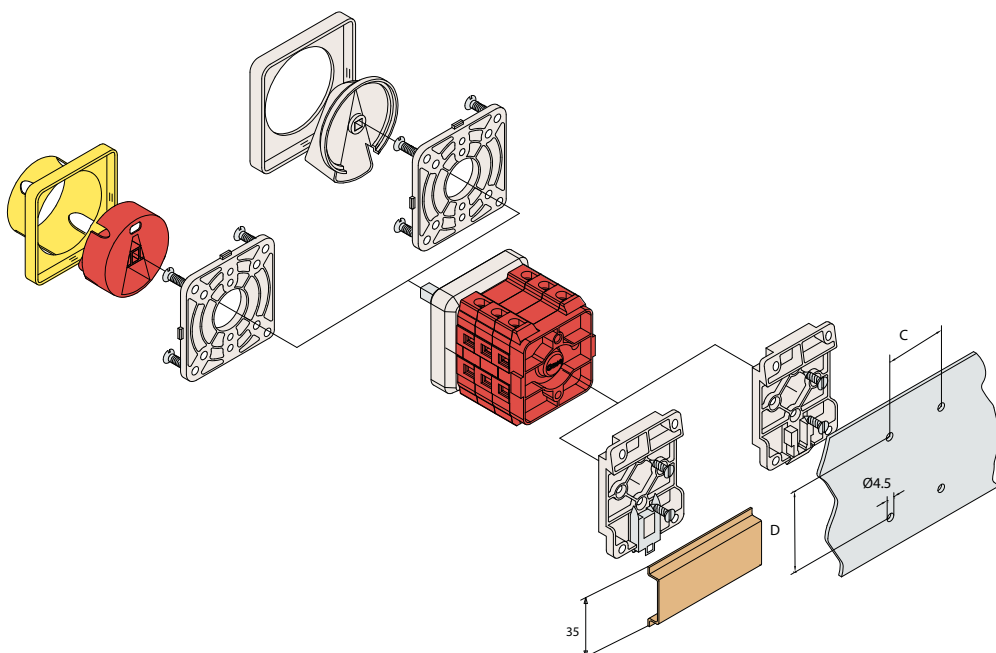

Interlock mounting

interlock

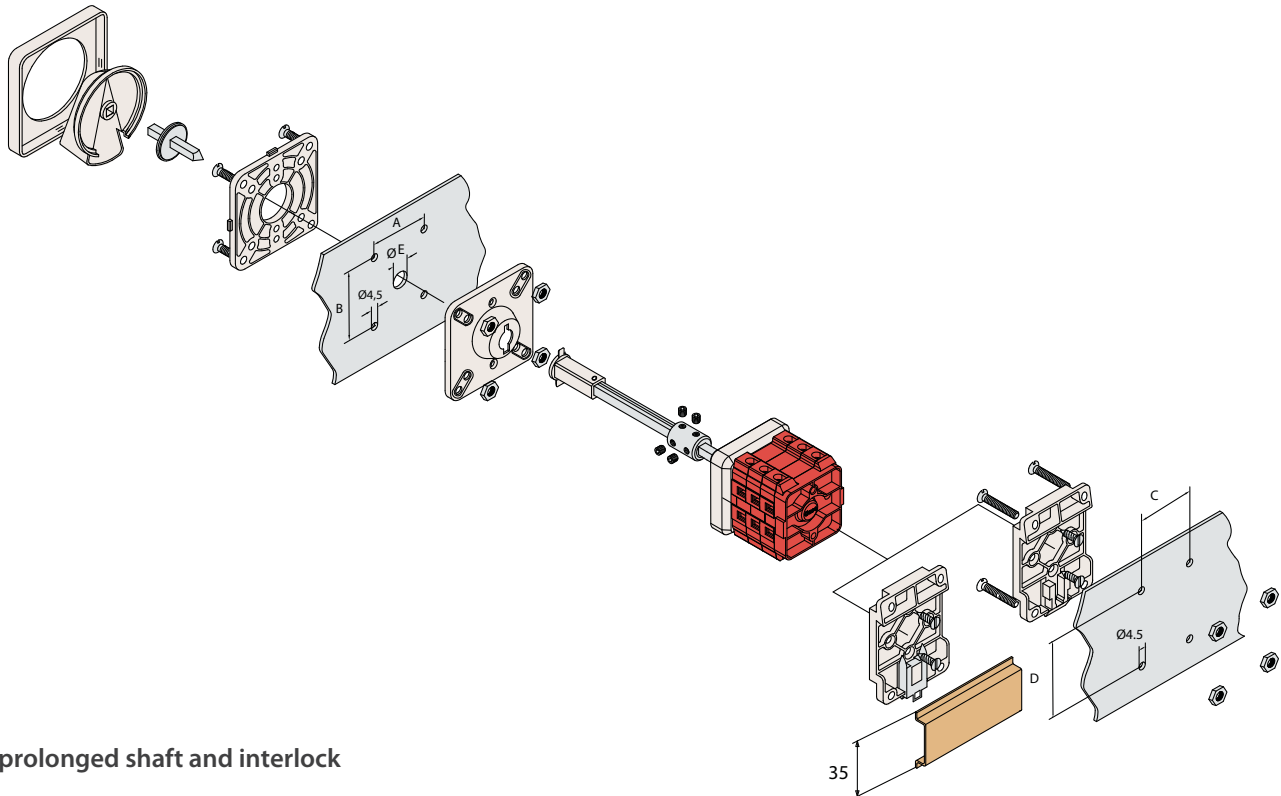

prolonged shaft and interlock

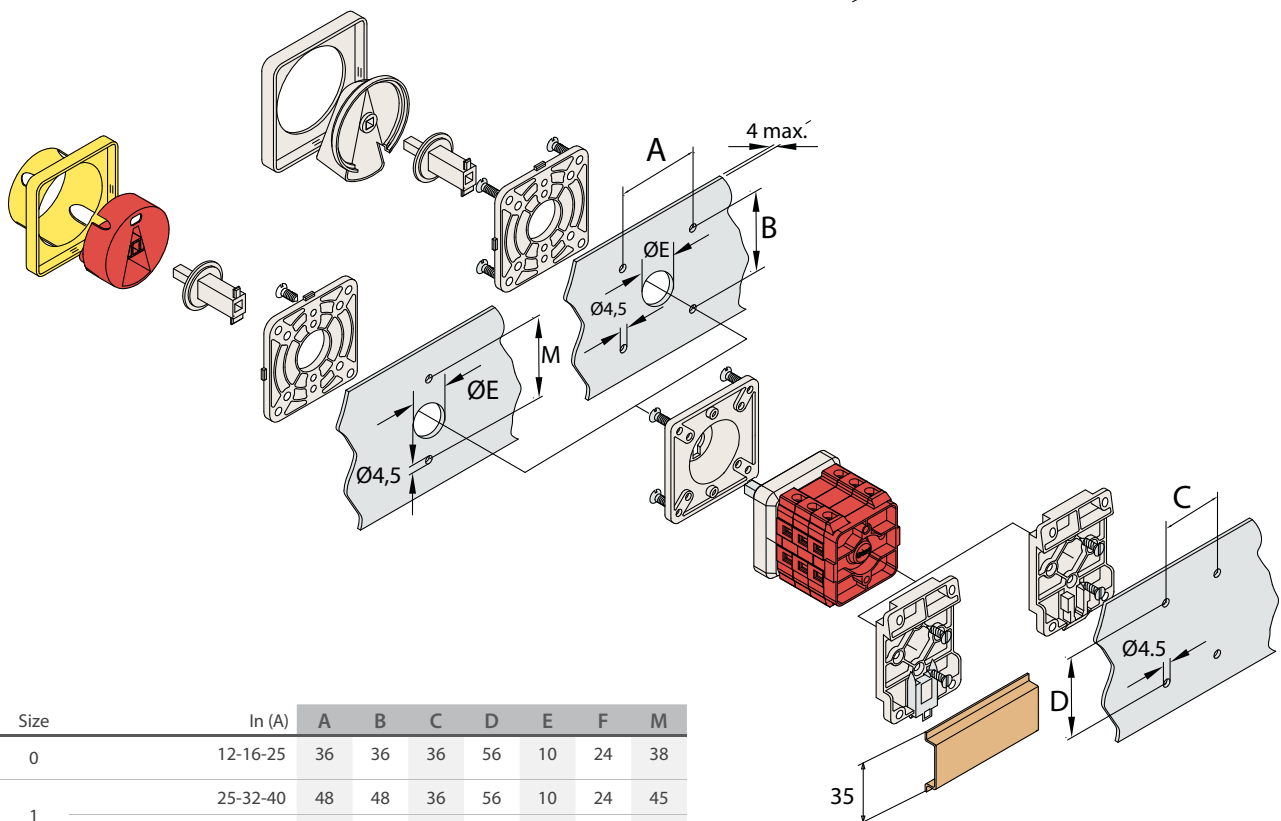

Size	In (A)	A	B	C	D	E	F	M
0	12-16-25	36	36	36	56	10	24	38
1	25-32-40	48	48	36	56	10	24	45
	63-100-125-160-200-250	48	48	78	78	14	24	45

values in mm

Special mountings



Mechanical red/green flag indicator

Characteristics	availability		
	size 0	size 1	size 5
central red/green flag indicates latest executed operation. Mounting from origin		●	●



Voltage selector lock

Characteristics	availability		
	size 0	size 1	size 5
front plate and handle with screw insert lock that allows operation from position 0 to 220 or 380		● (up to 40A)	●



Push and turn

Characteristics	availability		
	size 0	size 1	size 5
to operate the switch into a specific position is required to push the handle and turn	●	●	

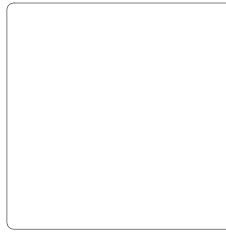

Key operating padlock

Characteristics	availability		
	size 0	size 1	size 5
standard key removable and lockable up to four different positions. Mounting from origin	●	● (up to 40A)	●
security KABA key removable and lockable only in on position. Mounting from origin		● (up to 40A)	●



Light indication

Characteristics	availability		
	size 0	size 1	size 5
frontplate with red pilot light at 380V. Mounting from origin	●	● (up to 40A)	●



Unidirectional

Characteristics	availability		
	size 0	size 1	size 5
allows to operate in a single direction	●	●	

Special mountings



Key interlock

Characteristics	availability		
	size 0	size 1	size 5
key removable and lockable in all positions		●	●



Switch lock mounting

Characteristics	availability		
	size 0	size 1	size 5
one position in main switch locks operation on secondary switch		● (up to 40A)	●



Tandem operation

Characteristics	availability		
	size 0	size 1	size 5
switches above 24 contacts		● (up to 40A)	●



Push button interlock

Characteristics	availability		
	size 0	size 1	size 5
push button releases cam switch handle always with DIN rail		● (up to 40A)	●

Mounting and installation accessories and options

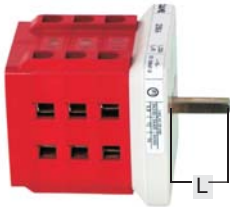

length L non standard

Special shafts

Characteristics	availability		
	size 0	size 1	size 5
Custom made shaft length	●	● (up to 40A)	●
Specific material construction			



Base mounting plates

References	availability		
	size 0	size 1	size 5
AK0000003	●	● (up to 40A)	●
AK0000006		● (63-250A)	



DIN rail mounting plates

References	availability		
	size 0	size 1	size 5
AK0100007	●	● (up to 40A)	●



Prolonged shaft

References	Length	availability		
		size 0	size 1	size 5
AK0800003	200 mm	●	● (up to 40A)	●
AK0800006	200 mm		● (63-250A)	



Allen screws

Characteristics	availability		
	size 0	size 1	size 5
Allen screws for improved access		● (63-250A)	



Gold contacts

Characteristics	availability		
	size 0	size 1	size 5
gold plated contacts for low voltages	●		

Clutches

Devices that permit back plate or DIN rail switch mounting while keeping with external handle operation. The handle unit detaches from the rotary shaft when opening the panel door. Compatible with direct handle and

padlockable handle. The assembly kits are supplied with rear mounting plate or DIN rail mounting plate. The kit without interlock permits panel door opening in all positions. The kit with interlock increases



assembly safety permitting panel door opening uniquely on 0 disconnect position. It is specially adequate on main switch or safety switch functions.



Kit without interlock

References	Shaft	Mounting plate	availability		
			size 0	size 1	size 5
AK0230003	-	rear	●	● (up to 40A)	●
AK0230006	-	rear		● (63-200A)	
AK1630003	200 mm	rear	●	● (up to 40A)	●
AK1630006	200 mm	rear		● (63-200A)	
AK0240003	-	DIN rail	●	● (up to 40A)	●
AK0240006	-	DIN rail		● (63-200A)	
AK1640003	200 mm	DIN rail	●	● (up to 40A)	●
AK1640006	200 mm	DIN rail		● (63-200A)	



Kit with interlock

References	Shaft	Mounting plate	availability		
			size 0	size 1	size 5
AK0330003	-	rear	●	● (up to 40A)	●
AK0330006	-	rear		● (63-200A)	
AK1730003	200 mm	rear	●	● (up to 40A)	●
AK1730006	200 mm	rear		● (63-200A)	
AK0340003	-	DIN rail	●	● (up to 40A)	●
AK0340006	-	DIN rail		● (63-200A)	
AK1740003	200 mm	DIN rail	●	● (up to 40A)	●
AK1740006	200 mm	DIN rail		● (63-200A)	

See mounting schemes at page 22-23

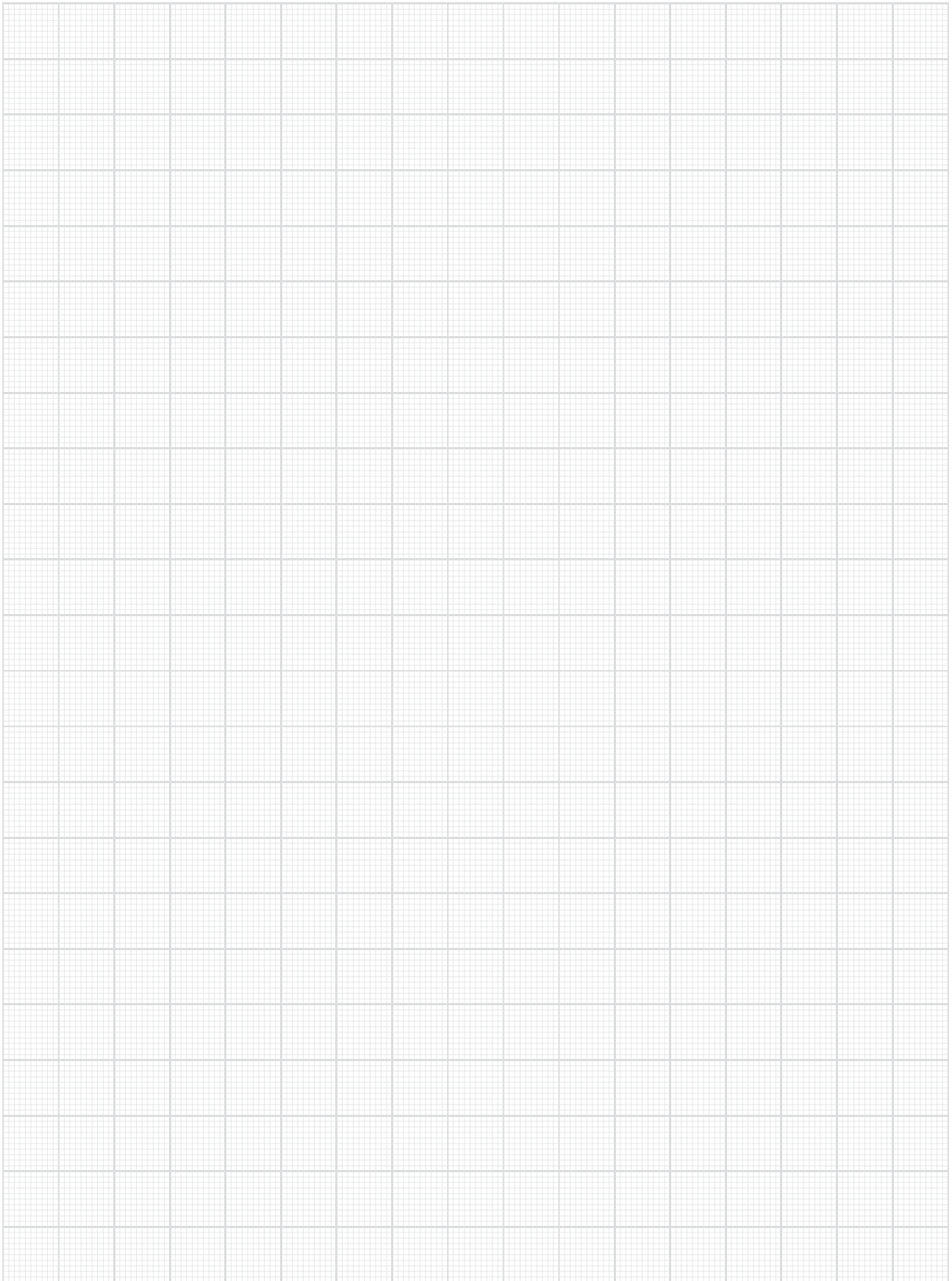

Handles and sets



Handles

References	Colour	availability		
		size 0	size 1	size 5
AK1000010	grey	●		
AK1000020	red	●		
AK1000040	black	●		
AK1000011	grey		●	
AK1000021	red		●	
AK1000041	black		●	
AK1000016	grey		● (63-100A)	
AK1000026	red		● (63-100A)	
AK1000046	black		● (63-100A)	



Screw handles

References	Colour	availability		
		size 0	size 1	size 5
AK1010040	black	●		
AK1010041	black		● (up to 40A)	
AK1010046	black		● (63-100A)	



Lever handles

References	Colour	availability		
		size 0	size 1	size 5
AK1000010	grey		● (up to 40A)	
AK1000020	red		● (up to 40A)	
AK1000016	grey		● (63-200A)	
AK1000026	red		● (63-200A)	
AK1000046	black		● (63-200A)	



see page 24

Front plate and handle set Voltage selector lock

References	availability		
	size 0	size 1	size 5
AK2700010		● (up to 40A)	
AK2700046		● (63-100A)	



Front plate and handle set
Padlockable handle

References	Colour	Mando	availability		
			size 0	size 1	size 5
AK1200523	■ ■ red/yellow	Short	●	● (up to 40A)	●
AK1200526	■ ■ red/yellow	Long		● (63-125A)	
AK1200528	■ ■ red/yellow	Lever		● (160-200A)	
AK1200143	■ ■ black/grey	Short	●	● (up to 40A)	●
AK1200146	■ ■ black/grey	Long		● (63-125A)	
AK1200148	■ ■ black/grey	Lever		● (160-200A)	



Front plate and handle set
Lockout handle

References	Colour	availability		
		size 0	size 1	size 5
AK1300523	■ ■ red/yellow	●		
AK1300143	■ ■ black/grey	●		

Plates and inscriptions

NV plates (without inscriptions)



References	Colour	availability		
		size 0	size 1	size 5
AK1800100	■ grey	●		
AK1800200	■ red	●		
AK1800400	■ black	●		
AK1830400	■ black and screw fixing	●		
AK1800104	■ grey		●	●
AK1800204	■ red		●	●
AK1800404	■ black		●	●
AK1830404	■ black and screw fixing		●	●

NVR plates (without inscriptions)



References	Colour	availability		
		size 0	size 1	size 5
AK1900100	■ grey	●		
AK1900200	■ red	●		
AK1900104	■ grey		●	●
AK1900204	■ red		●	●

Protection accessories

Protectors



References	Cells	availability		
		size 0	size 1	size 5
AK0601000	1 and 2 cells	●		
AK0602000	3 to 5 cells	●		
AK0603000	6 to 8 cells	●		
AK0601001	1 and 2 cells		●	●
AK0602001	3 to 5 cells		●	●
AK0603001	6 to 8 cells		●	●



IP65 gaskets

References	availability		
	size 0	size 1	size 5
AK2240003	●	● (up to 40A)	●
AK2240006		● (63-250A)	●



Terminal shrouds

References	Cells	availability		
		size 0	size 1	size 5
AK0702009	2 cells		● (160-250A)	
AK0703009	3 cells		● (160-250A)	
AK0704009	4 cells		● (160-250A)	

Enclosures



IP55 Plastic enclosure

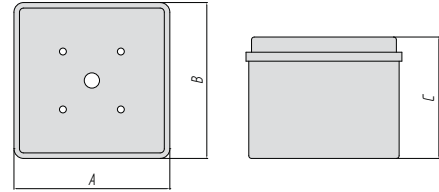

References	Cells	dimensions			availability		
		A	B	C	size 0	size 1	size 5
AK1401000	1 to 6 cells	113	113	88	●		
AK1401001	1 to 4 cells	113	113	88		● (up to 40A)	●



IP40 Metal enclosure

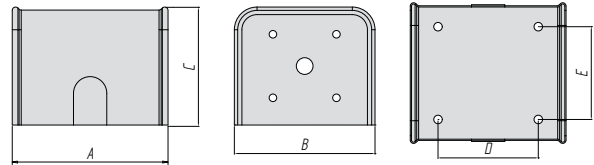

References	Cells	dimensions					availability		
		A	B	C	D	E	size 0	size 1	size 5
AK0901000	1 to 6 cells	103	93	82	80	67	●		
AK0902001	1 to 4 cells	103	93	82	80	67		● (up to 40A)	●
AK0903001	5 to 10 cells	103	93	62	80	67		● (up to 40A)	●
AK0904001	7 to 12 cells	103	93	62	80	67		● (up to 40A)	●





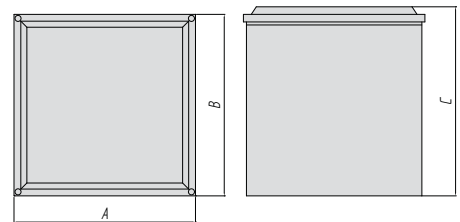









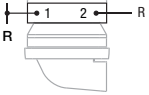

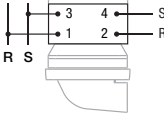
IP65 Aluminium enclosure

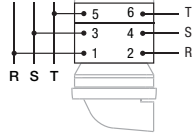

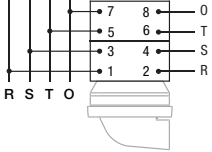

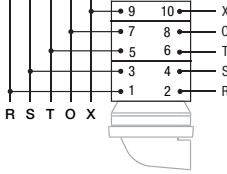

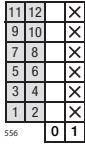
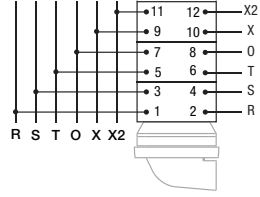

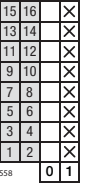
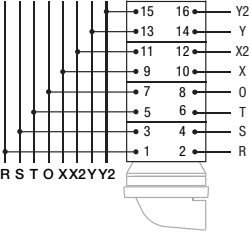

References	Cells	dimensions			availability		
		A	B	C	size 0	size 1	size 5
AK1501000	1 and 2 cells	110	110	50		● (up to 40A)	●
AK1501000	1 to 3 cells	110	110	50			●
AK1501001	3 to 8 cells	110	110	120		● (up to 40A)	●
AK1501001	4 to 10 cells	110	110	120			●
AK1502006	1 to 5 cells	200	300	105		● (63-125A)	

Standard electrical schemes

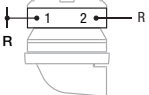
Switches

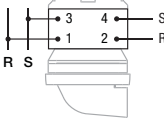
 <p>550 1 pole 1 cell</p>  	 <p>551 2 poles 1 cell</p>  	 <p>552 3 poles 2 cells</p>  
 <p>553 4 poles 2 cells</p>  	 <p>555 5 poles 3 cells</p>  	 <p>556 6 poles 3 cells</p>  
 <p>558 8 poles 4 cells</p>  		

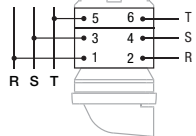
Switches spring return to off

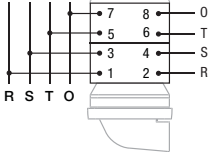
 <p>820 1 poles 1 cell</p>  	 <p>821 2 poles 1 cell</p>  	 <p>822 3 poles 2 cells</p>  
 <p>823 4 poles 2 cells</p>  		

Changeover switches with off position

<p>560 1 pole 1 cell</p>	<p>561 2 poles 2 cells</p>	<p>562 3 poles 3 cells</p>		
<p>563 4 poles 4 cells</p>	<p>565 5 poles 5 cells</p>	<p>566 6 poles 6 cells</p>		
<p>567 7 poles 7 cells</p>				

Standard electrical schemes

Changeover switches spring return to off

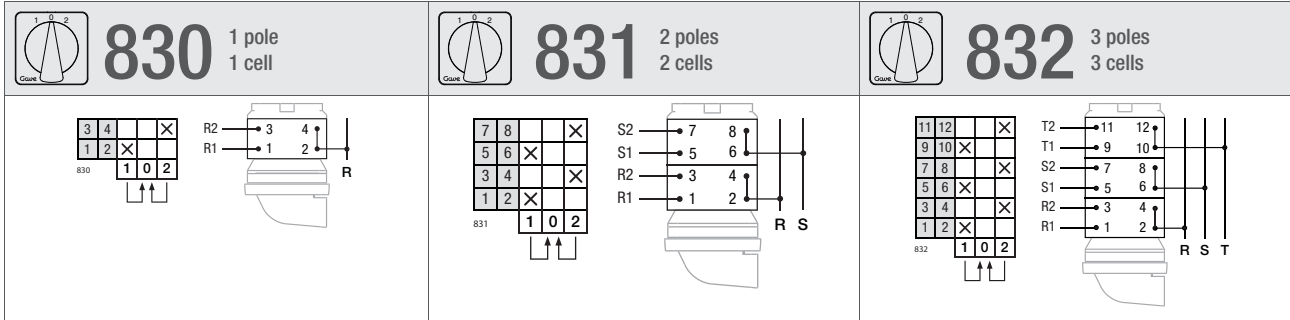

Changeover switches without off position

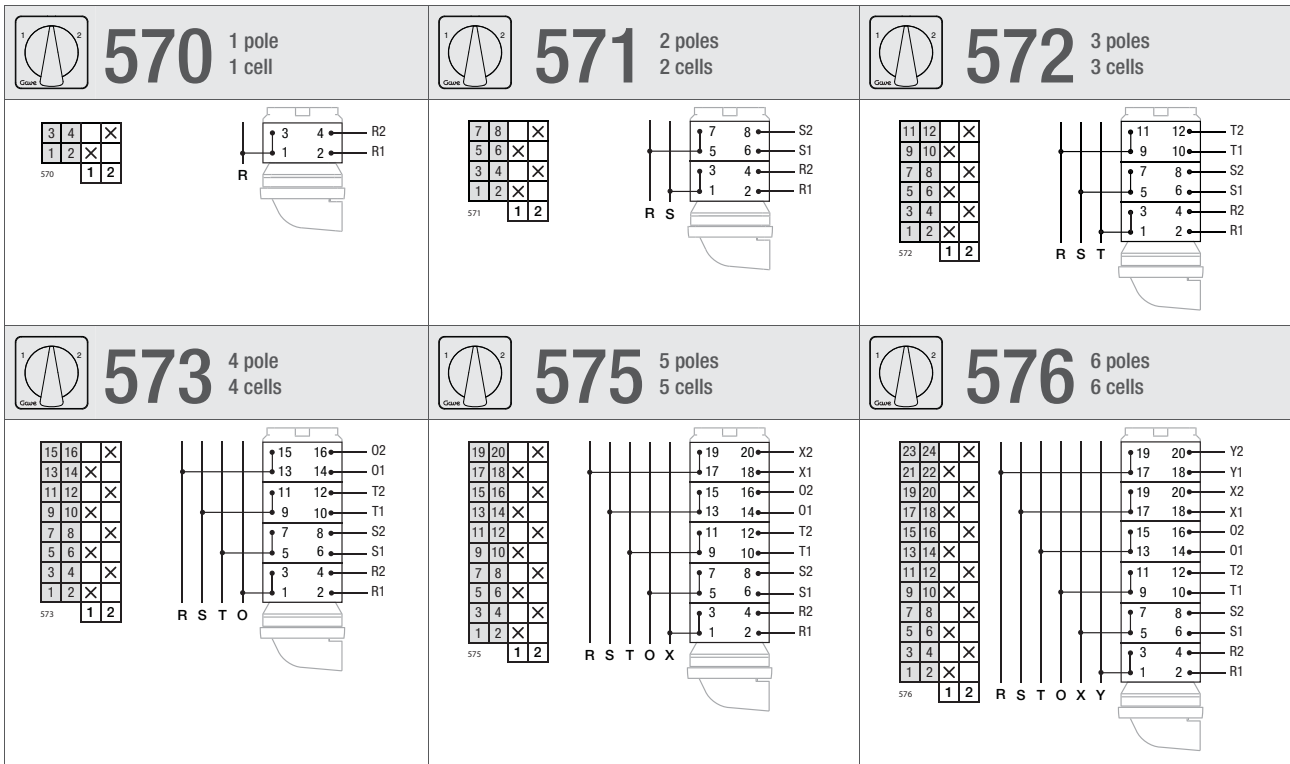

Step switches without off position
SINGLE POLE

<p>580 3 positions 2 cells</p>	<p>581 4 positions 2 cells</p>	<p>582 5 positions 3 cells</p>
<p>583 6 positions 3 cells</p>		

DOUBLE POLE

<p>590 3 positions 3 cells</p>	<p>591 4 positions 4 cells</p>	<p>592 5 positions 5 cells</p>
<p>593 6 positions 6 cells</p>		

Standard electrical schemes

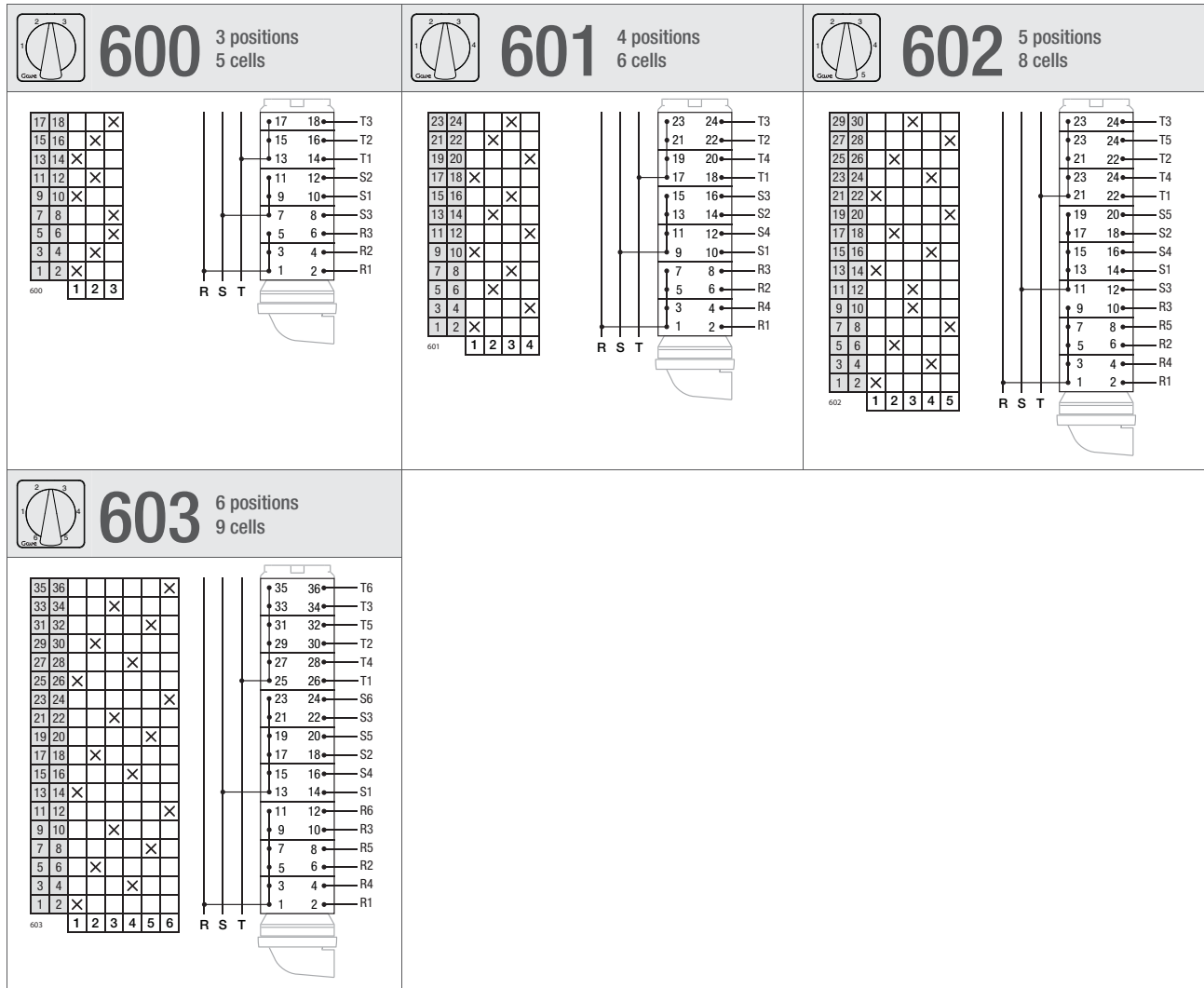

Step switches without off position
TRIPLE POLE



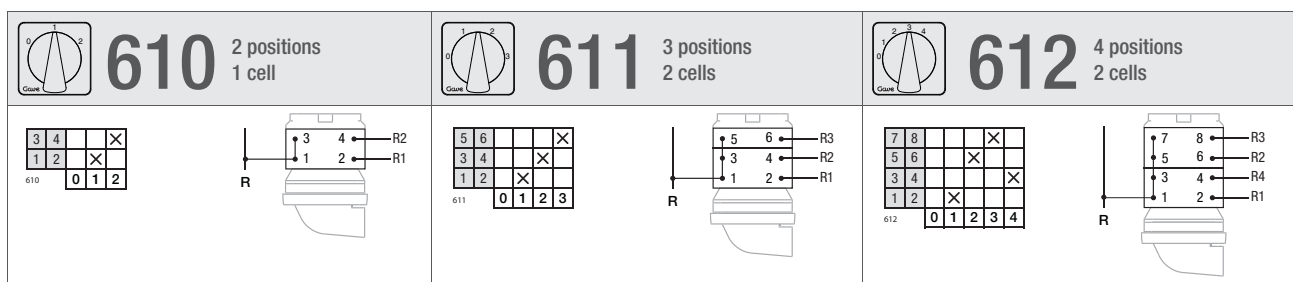



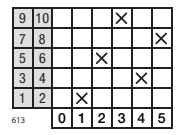
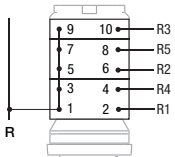
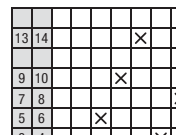
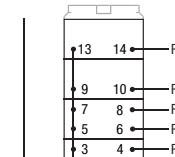

Step switches with off position
SINGLE POLE

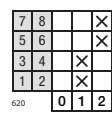
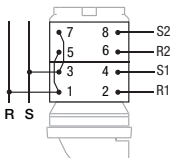
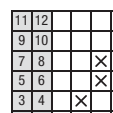
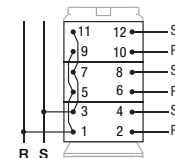
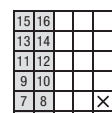
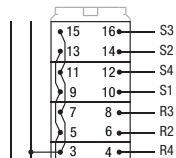

Step switches with off position
SINGLE POLE

 <p>613 5 positions 3 cells</p>	 <p>614 6 positions 4 cells</p>
 	 

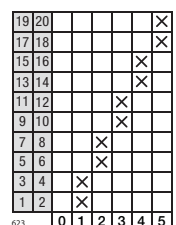
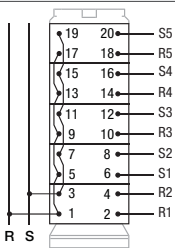

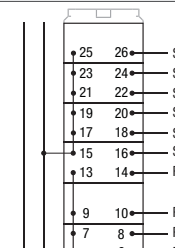



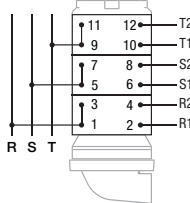

DOUBLE POLE

 <p>620 2 positions 2 cells</p>	 <p>621 3 positions 3 cells</p>	 <p>622 4 positions 4 cells</p>
 	 	 
 <p>623 5 positions 5 cells</p>	 <p>624 6 positions 7 cells</p>	
 	 	

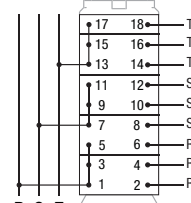
Standard electrical schemes

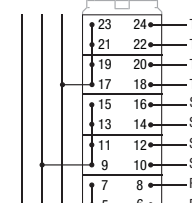
Step switches with off position

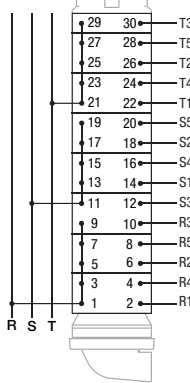
TRIPLE POLE

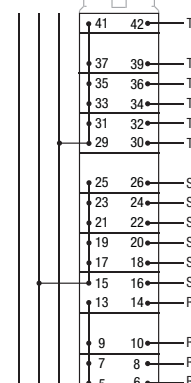
 <p>630 2 positions 3 cells</p> <table border="1" data-bbox="167 571 271 716"> <tr><td>11</td><td>12</td><td></td><td>X</td></tr> <tr><td>9</td><td>10</td><td>X</td><td></td></tr> <tr><td>7</td><td>8</td><td></td><td>X</td></tr> <tr><td>5</td><td>6</td><td>X</td><td></td></tr> <tr><td>3</td><td>4</td><td></td><td>X</td></tr> <tr><td>1</td><td>2</td><td>X</td><td></td></tr> </table>  <p>R S T</p>	11	12		X	9	10	X		7	8		X	5	6	X		3	4		X	1	2	X		 <p>631 3 positions 5 cells</p> <table border="1" data-bbox="590 571 694 716"> <tr><td>17</td><td>18</td><td></td><td>X</td></tr> <tr><td>15</td><td>16</td><td></td><td>X</td></tr> <tr><td>13</td><td>14</td><td>X</td><td></td></tr> <tr><td>11</td><td>12</td><td></td><td>X</td></tr> <tr><td>9</td><td>10</td><td>X</td><td></td></tr> <tr><td>7</td><td>8</td><td></td><td>X</td></tr> <tr><td>5</td><td>6</td><td>X</td><td></td></tr> <tr><td>3</td><td>4</td><td></td><td>X</td></tr> <tr><td>1</td><td>2</td><td>X</td><td></td></tr> </table>  <p>R S T</p>	17	18		X	15	16		X	13	14	X		11	12		X	9	10	X		7	8		X	5	6	X		3	4		X	1	2	X		 <p>632 4 positions 6 cells</p> <table border="1" data-bbox="1021 571 1125 716"> <tr><td>23</td><td>24</td><td></td><td>X</td></tr> <tr><td>21</td><td>22</td><td></td><td>X</td></tr> <tr><td>19</td><td>20</td><td>X</td><td></td></tr> <tr><td>17</td><td>18</td><td>X</td><td></td></tr> <tr><td>15</td><td>16</td><td></td><td>X</td></tr> <tr><td>13</td><td>14</td><td>X</td><td></td></tr> <tr><td>11</td><td>12</td><td></td><td>X</td></tr> <tr><td>9</td><td>10</td><td>X</td><td></td></tr> <tr><td>7</td><td>8</td><td></td><td>X</td></tr> <tr><td>5</td><td>6</td><td>X</td><td></td></tr> <tr><td>3</td><td>4</td><td></td><td>X</td></tr> <tr><td>1</td><td>2</td><td>X</td><td></td></tr> </table>  <p>R S T</p>	23	24		X	21	22		X	19	20	X		17	18	X		15	16		X	13	14	X		11	12		X	9	10	X		7	8		X	5	6	X		3	4		X	1	2	X																								
11	12		X																																																																																																																																		
9	10	X																																																																																																																																			
7	8		X																																																																																																																																		
5	6	X																																																																																																																																			
3	4		X																																																																																																																																		
1	2	X																																																																																																																																			
17	18		X																																																																																																																																		
15	16		X																																																																																																																																		
13	14	X																																																																																																																																			
11	12		X																																																																																																																																		
9	10	X																																																																																																																																			
7	8		X																																																																																																																																		
5	6	X																																																																																																																																			
3	4		X																																																																																																																																		
1	2	X																																																																																																																																			
23	24		X																																																																																																																																		
21	22		X																																																																																																																																		
19	20	X																																																																																																																																			
17	18	X																																																																																																																																			
15	16		X																																																																																																																																		
13	14	X																																																																																																																																			
11	12		X																																																																																																																																		
9	10	X																																																																																																																																			
7	8		X																																																																																																																																		
5	6	X																																																																																																																																			
3	4		X																																																																																																																																		
1	2	X																																																																																																																																			
 <p>633 5 positions 8 cells</p> <table border="1" data-bbox="167 1012 271 1158"> <tr><td>29</td><td>30</td><td></td><td>X</td></tr> <tr><td>27</td><td>28</td><td></td><td>X</td></tr> <tr><td>25</td><td>26</td><td>X</td><td></td></tr> <tr><td>23</td><td>24</td><td></td><td>X</td></tr> <tr><td>21</td><td>22</td><td>X</td><td></td></tr> <tr><td>19</td><td>20</td><td></td><td>X</td></tr> <tr><td>17</td><td>18</td><td>X</td><td></td></tr> <tr><td>15</td><td>16</td><td></td><td>X</td></tr> <tr><td>13</td><td>14</td><td>X</td><td></td></tr> <tr><td>11</td><td>12</td><td></td><td>X</td></tr> <tr><td>9</td><td>10</td><td>X</td><td></td></tr> <tr><td>7</td><td>8</td><td></td><td>X</td></tr> <tr><td>5</td><td>6</td><td>X</td><td></td></tr> <tr><td>3</td><td>4</td><td></td><td>X</td></tr> <tr><td>1</td><td>2</td><td>X</td><td></td></tr> </table>  <p>R S T</p>	29	30		X	27	28		X	25	26	X		23	24		X	21	22	X		19	20		X	17	18	X		15	16		X	13	14	X		11	12		X	9	10	X		7	8		X	5	6	X		3	4		X	1	2	X		 <p>634 6 positions 11 cells</p> <table border="1" data-bbox="590 1012 694 1158"> <tr><td>41</td><td>42</td><td></td><td>X</td></tr> <tr><td>37</td><td>38</td><td></td><td>X</td></tr> <tr><td>35</td><td>36</td><td></td><td>X</td></tr> <tr><td>33</td><td>34</td><td>X</td><td></td></tr> <tr><td>31</td><td>32</td><td></td><td>X</td></tr> <tr><td>29</td><td>30</td><td>X</td><td></td></tr> <tr><td>25</td><td>26</td><td></td><td>X</td></tr> <tr><td>23</td><td>24</td><td></td><td>X</td></tr> <tr><td>21</td><td>22</td><td>X</td><td></td></tr> <tr><td>19</td><td>20</td><td></td><td>X</td></tr> <tr><td>17</td><td>18</td><td>X</td><td></td></tr> <tr><td>15</td><td>16</td><td></td><td>X</td></tr> <tr><td>13</td><td>14</td><td>X</td><td></td></tr> <tr><td>9</td><td>10</td><td></td><td>X</td></tr> <tr><td>7</td><td>8</td><td>X</td><td></td></tr> <tr><td>5</td><td>6</td><td></td><td>X</td></tr> <tr><td>3</td><td>4</td><td>X</td><td></td></tr> <tr><td>1</td><td>2</td><td></td><td>X</td></tr> </table>  <p>R S T</p>	41	42		X	37	38		X	35	36		X	33	34	X		31	32		X	29	30	X		25	26		X	23	24		X	21	22	X		19	20		X	17	18	X		15	16		X	13	14	X		9	10		X	7	8	X		5	6		X	3	4	X		1	2		X
29	30		X																																																																																																																																		
27	28		X																																																																																																																																		
25	26	X																																																																																																																																			
23	24		X																																																																																																																																		
21	22	X																																																																																																																																			
19	20		X																																																																																																																																		
17	18	X																																																																																																																																			
15	16		X																																																																																																																																		
13	14	X																																																																																																																																			
11	12		X																																																																																																																																		
9	10	X																																																																																																																																			
7	8		X																																																																																																																																		
5	6	X																																																																																																																																			
3	4		X																																																																																																																																		
1	2	X																																																																																																																																			
41	42		X																																																																																																																																		
37	38		X																																																																																																																																		
35	36		X																																																																																																																																		
33	34	X																																																																																																																																			
31	32		X																																																																																																																																		
29	30	X																																																																																																																																			
25	26		X																																																																																																																																		
23	24		X																																																																																																																																		
21	22	X																																																																																																																																			
19	20		X																																																																																																																																		
17	18	X																																																																																																																																			
15	16		X																																																																																																																																		
13	14	X																																																																																																																																			
9	10		X																																																																																																																																		
7	8	X																																																																																																																																			
5	6		X																																																																																																																																		
3	4	X																																																																																																																																			
1	2		X																																																																																																																																		

Star-delta changeover switches

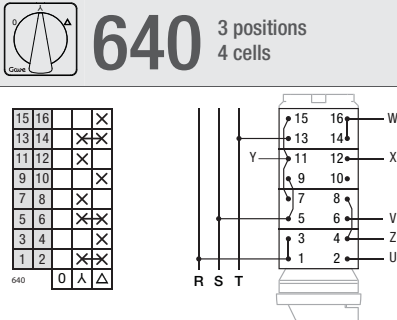
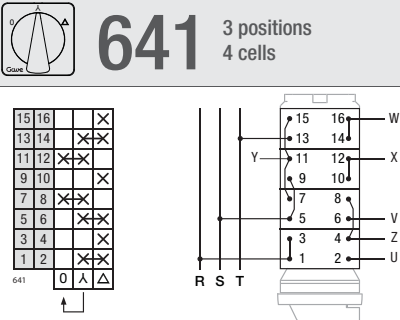
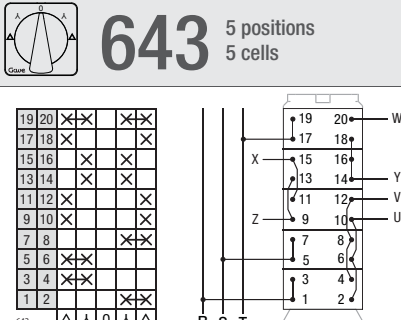
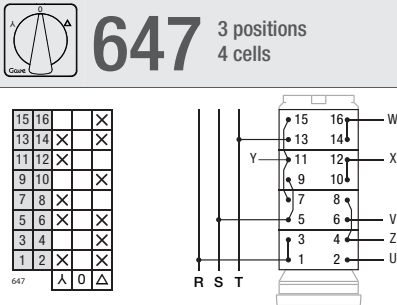
 <p>640 3 positions 4 cells</p> <p>U • V • W • 2 6 16</p> <p>4 12 11 Z • X • Y •</p>	 <p>641 3 positions 4 cells</p> <p>U • V • W • 2 6 16</p> <p>4 12 11 Z • X • Y •</p>	 <p>643 5 positions 5 cells</p> <p>U • V • W • 10 12 20</p> <p>9 15 14 Z • X • Y •</p>
 <p>647 3 positions 4 cells</p> <p>U • V • W • 2 6 16</p> <p>4 12 11 Z • X • Y •</p>		

Reversing switches

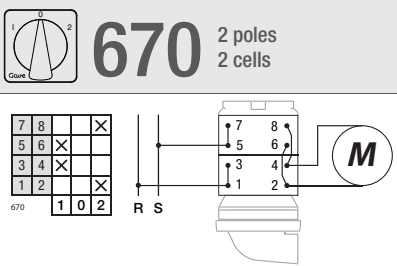
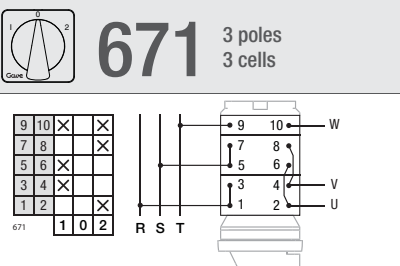
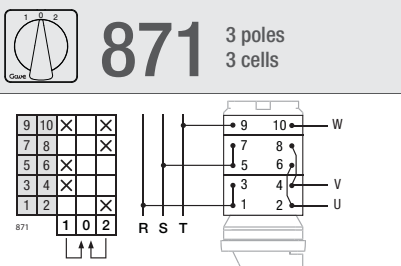
 <p>670 2 poles 2 cells</p> <p>U • V • W • 2 4 10</p> <p>2 4 10</p>	 <p>671 3 poles 3 cells</p> <p>U • V • W • 2 4 10</p> <p>2 4 10</p>	 <p>871 3 poles 3 cells</p> <p>U • V • W • 2 4 10</p> <p>U • V • W • 2 4 10</p>
---	---	---

Standard electrical schemes

Pole changing switches for 2 speeds

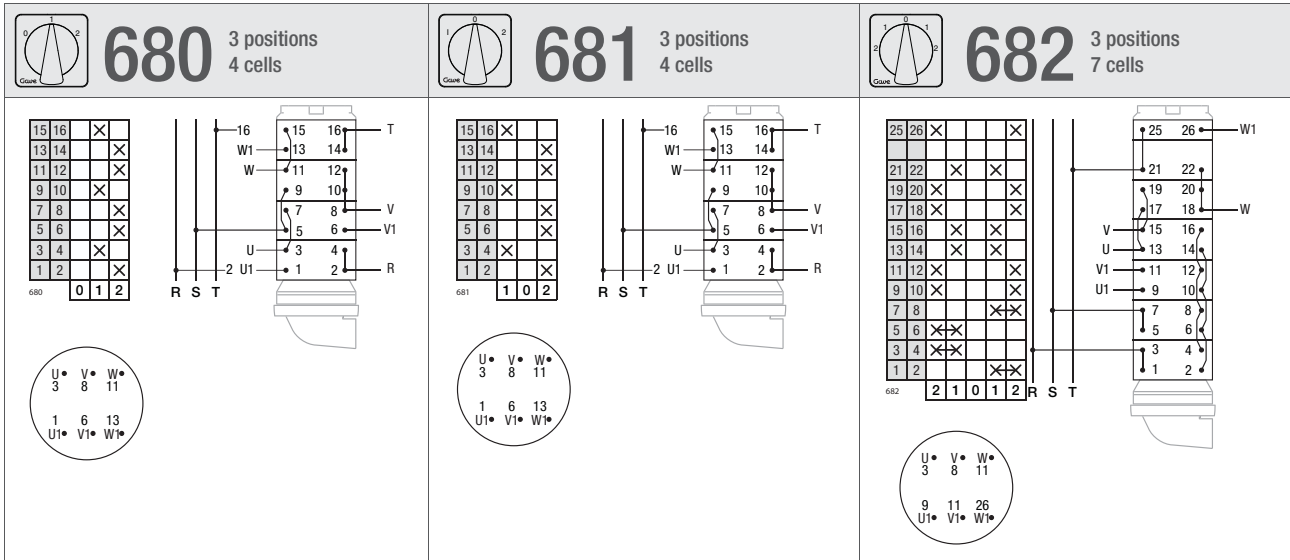

Pole changing switches for 3 speeds

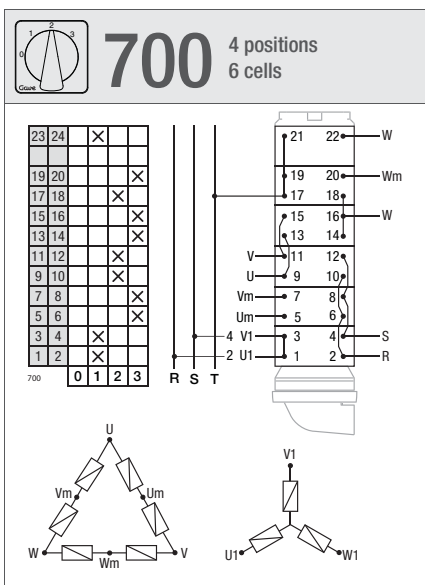



Voltmeter changeover switches



743 3 phases
2 cells

7	8		X	X
5	6	X	X	
3	4	X		
1	2		X	

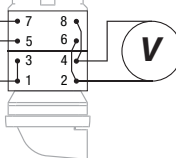
0	RS	ST	TR
---	----	----	----







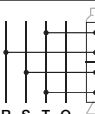
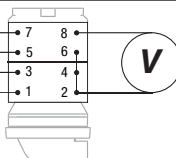

744 3 phases + N
2 cells

7	8	X	X
5	6	X	
3	4	X	
1	2		X

0	RO	SO	TO
---	----	----	----







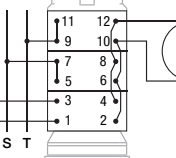

746 3 phases + N
4 cells

11	12		X	X
9	10		X	X
7	8	X		X
5	6		X	X
3	4	X	X	
1	2	X	X	

0	RO	SO	TO	0	TR	ST	RS
---	----	----	----	---	----	----	----







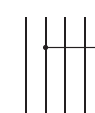
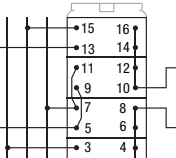

747 3 phases
4 cells

15	16		X	X
13	14	X	X	
11	12		X	X
9	10		X	
7	8		X	X
5	6	X		
3	4		X	X
1	2	X	X	

0	RS	ST	TR	0	RS	ST	TR
LINE 1				LINE 2			



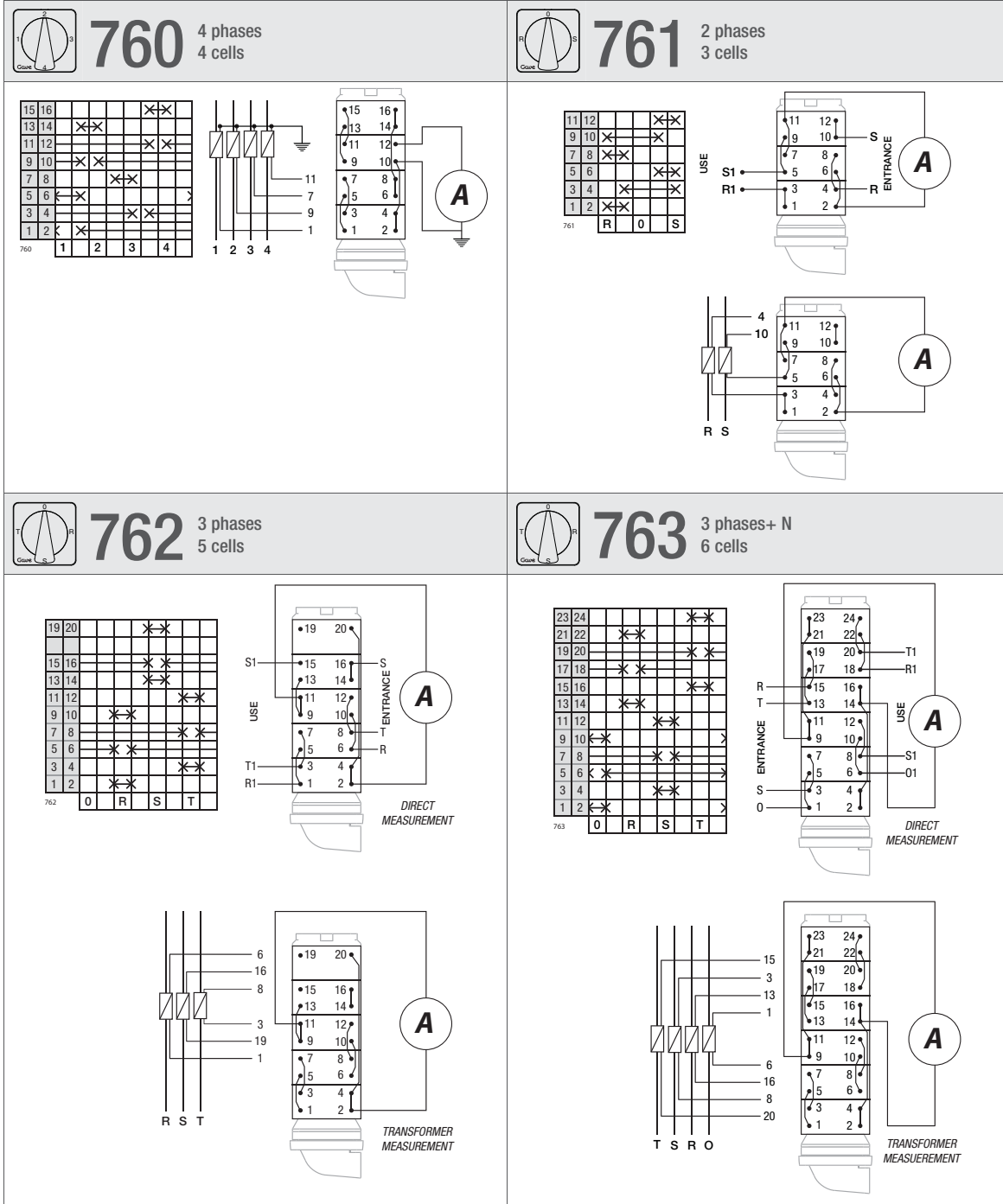

Standard electrical schemes

Ammeter changeover switches

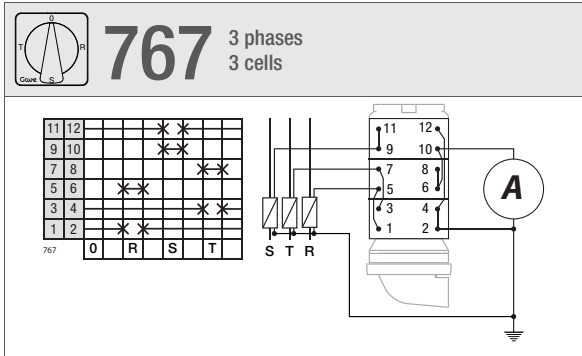

Ammeter changeover switches





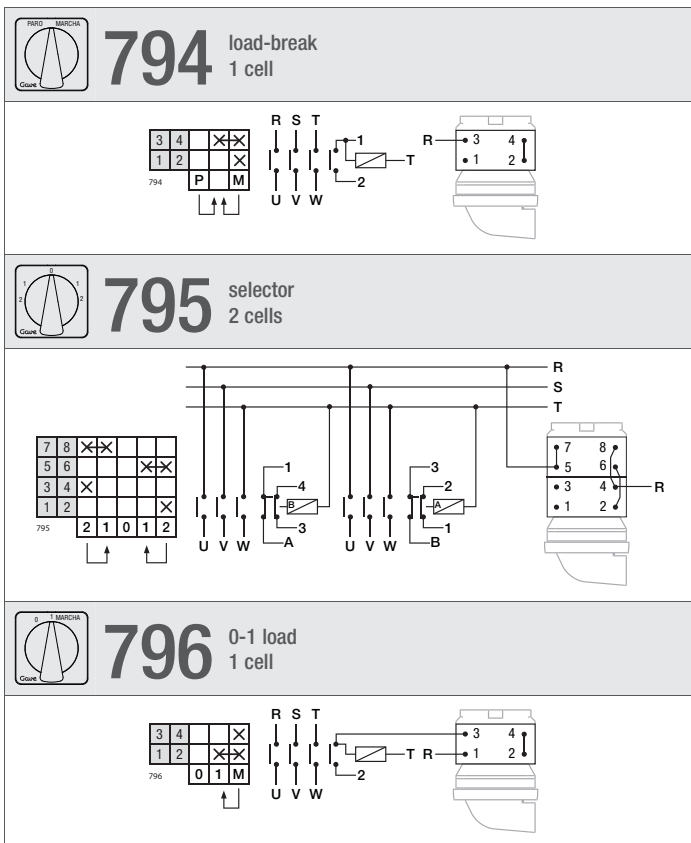





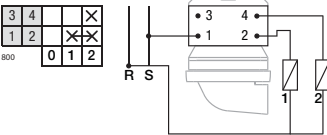

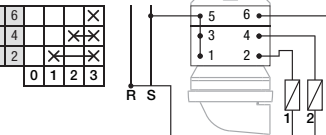

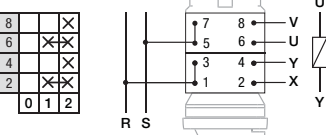
Manipulator changeover switches

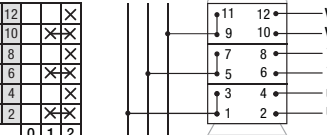
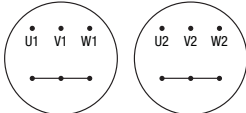

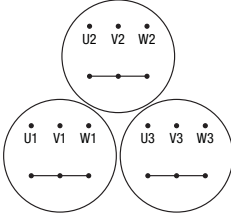
Standard electrical schemes

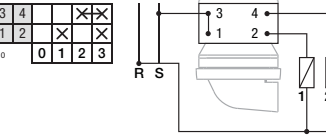
Group changeover switches

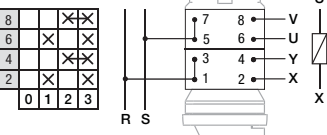
 <p>800 two selectors 1 cell</p> 	 <p>801 three selectors 2 cells</p> 	 <p>802 two selectors 2 cells</p> 
 <p>804 two selectors 3 cells</p>  	 <p>805 three selectors 5 cells</p>  	 <p>810 two selectors 1 cell</p> 
 <p>811 two selectors 2 cells</p> 		

Circuit breaker for motor starting



840 2 poles
2 cells

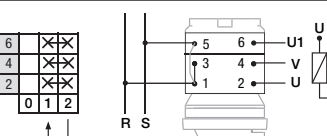

Overlapping changeover switches

<p>540 1 pole 1 cell</p>	<p>541 2 poles 2 cells</p>	<p>542 3 poles 3 cells</p>
<p>543 4 poles 4 cells</p>		

By-Pass changeover switches

<p>983 4 poles 4 cells</p>	<p>984 4 poles 6 cells</p>
---------------------------------------	---------------------------------------

Special diagrams

Photocopy and complete the following form to request special diagrams.

Gawe

Reference

Number of units

Customer

Outside connections																	
<input type="checkbox"/>	<input type="checkbox"/>	<input type="checkbox"/>	<input type="checkbox"/>	<input type="checkbox"/>	<input type="checkbox"/>	<input type="checkbox"/>	<input type="checkbox"/>	<input type="checkbox"/>	<input type="checkbox"/>	<input type="checkbox"/>	<input type="checkbox"/>	<input type="checkbox"/>	<input type="checkbox"/>	<input type="checkbox"/>	<input type="checkbox"/>	<input type="checkbox"/>	<input type="checkbox"/>
1	3	5	7	9	11	13	15	17	19	21	23	25	27	29	31	33	35
<input type="checkbox"/>	<input type="checkbox"/>	<input type="checkbox"/>	<input type="checkbox"/>	<input type="checkbox"/>	<input type="checkbox"/>	<input type="checkbox"/>	<input type="checkbox"/>	<input type="checkbox"/>	<input type="checkbox"/>	<input type="checkbox"/>	<input type="checkbox"/>	<input type="checkbox"/>	<input type="checkbox"/>	<input type="checkbox"/>	<input type="checkbox"/>	<input type="checkbox"/>	<input type="checkbox"/>
2	4	6	8	10	12	14	16	18	20	22	24	26	28	30	32	34	36
<input type="checkbox"/>	<input type="checkbox"/>	<input type="checkbox"/>	<input type="checkbox"/>	<input type="checkbox"/>	<input type="checkbox"/>	<input type="checkbox"/>	<input type="checkbox"/>	<input type="checkbox"/>	<input type="checkbox"/>	<input type="checkbox"/>	<input type="checkbox"/>	<input type="checkbox"/>	<input type="checkbox"/>	<input type="checkbox"/>	<input type="checkbox"/>	<input type="checkbox"/>	<input type="checkbox"/>
37	39	41	43	45	47												
<input type="checkbox"/>	<input type="checkbox"/>	<input type="checkbox"/>	<input type="checkbox"/>	<input type="checkbox"/>	<input type="checkbox"/>												

Plate inscription	Inside connections																	

Legend

close contact
 close contact in different positions with no interruption
 return from the last position to the previous one

Outside connections

bridge

maximum number of characters for printing in 45° / 90°

maximum number of characters for printing in 30° / 60°

Operation rating Ie (A)

Size 0	<input type="checkbox"/> 12	Size 1	<input type="checkbox"/> 25	<input type="checkbox"/> 125
	<input type="checkbox"/> 16		<input type="checkbox"/> 32	<input type="checkbox"/> 160
	<input type="checkbox"/> 25		<input type="checkbox"/> 40	<input type="checkbox"/> 200
			<input type="checkbox"/> 63	<input type="checkbox"/> 250
			<input type="checkbox"/> 100	

Prolonged shaft

Special long shaft

Length (L): _____ mm

Comments

Handle type

short

Black
 Red
 Grey

Lever

Black
 Red
 Grey

NOTE: Contacts order and switching angle might change due to constructional reasons.

46 **Gawe** low voltage electrical material

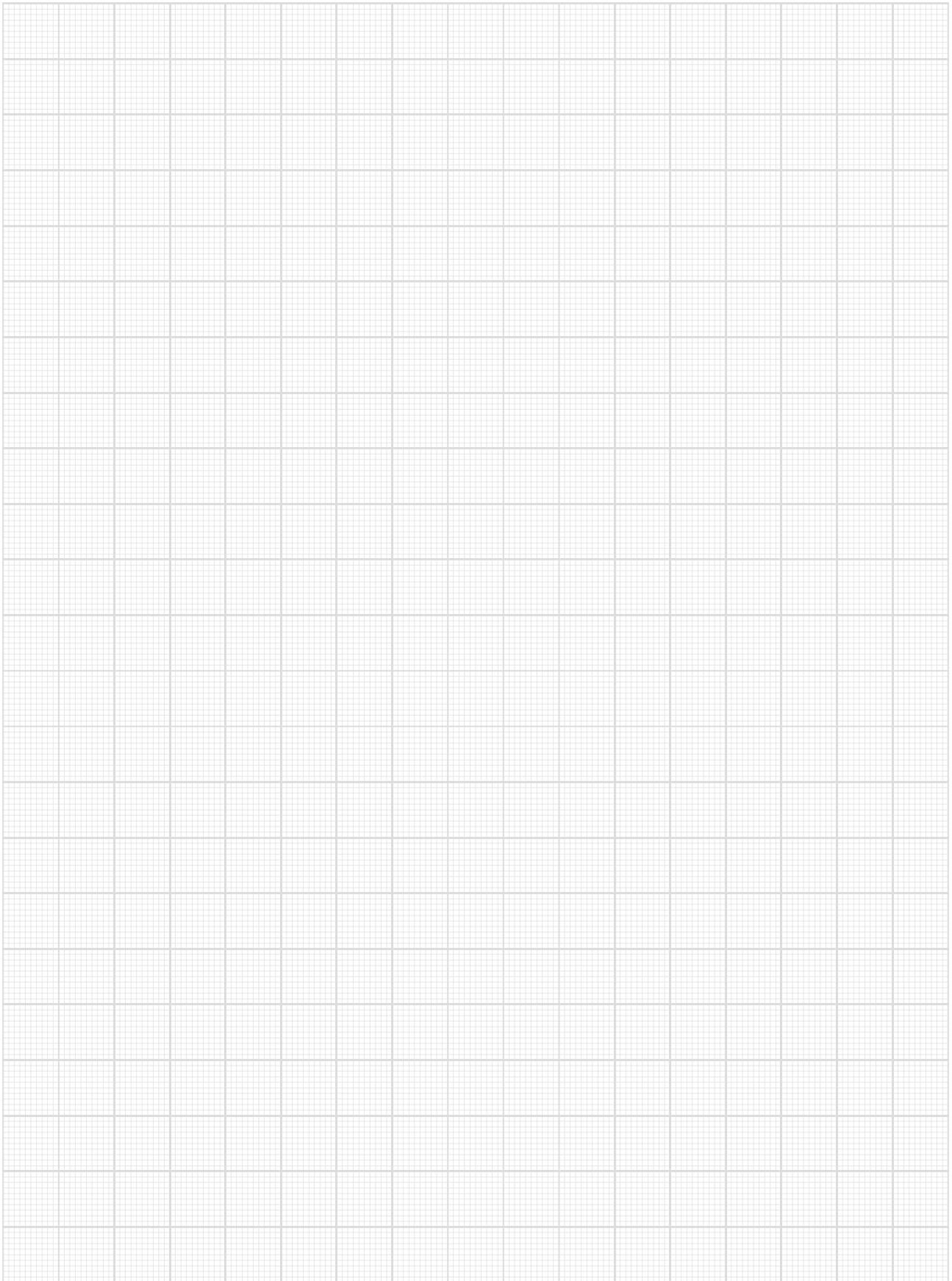



Main switches with undervoltage release

Undervoltage release switches have as a main function to guarantee user safety avoiding risks associated to power failure. They are multipole manually operated switch disconnectors that after power failure jump back to "stop" position and prevent machine automatic restarting at recovery voltage, requiring manual operation for machine restart.

According to

- IEC 60947-3
- IEC 60204-7
- UL508

General characteristics

- Triple pole main switch disconnectors with undervoltage release.
- Maximum padlock diameter 9mm.
- Complete range from 25 up to 63A.
- 230 and 400V coil releases.
- Protection degree IP54.
- Red/Yellow padlockable handle..

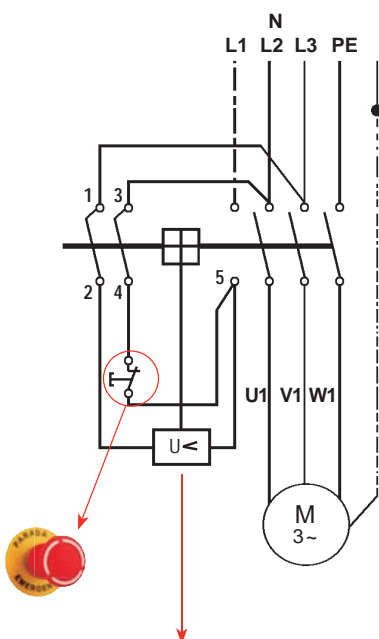

Energising = 85%
De-energising 35...75%
Continuous operation 100%

«Safety on machinery electrical equipment standard IEC/EN 60204-1 requires on section 7.5 *Protection against automatic restart after power failure and reappearance voltage.*»

Connection diagram

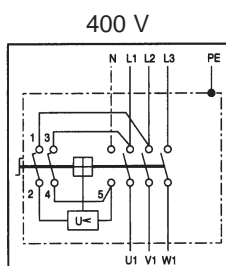
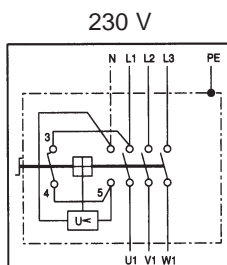

Technical data

description		values		
operational rating	I_e	25	40	63
connection screws		M 3,5	M 4	M 5
wire section				
	stranded mm^2	1 - 4	1 - 6	1,5 - 10
	flexible mm^2	1 - 2,5	1 - 4	1,5 - 6
impulse voltage	U_{imp} KV	6	6	6
	AC23 kW 3 x 400V	7,5	11	18,5
	AC3 kW 3 x 400V	11	15	22
conditional shortcircuit current	I_{cc} kA	6	6	6

Dimensions

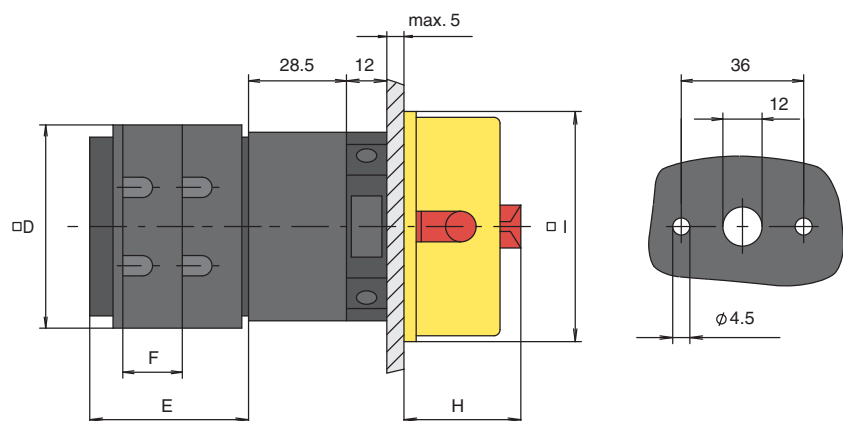
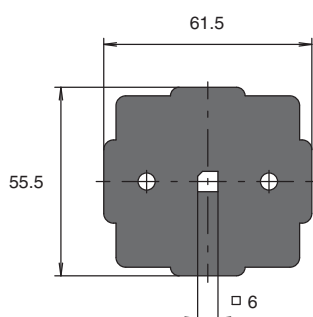

	D	E	F	H	I
25A	49	36	12,5	32	66
40A	62	38	12,5	32	66
63A	72	47	17,5	32	66



Discrepancy switches

«An advanced solution introducing new technological advantages on discrepancy applications»

Discrepancy switches are used to control, monitor position of disconnecter switches and circuit breakers, and signal any discrepancy on their operation. They are also used to send short impulses to remote controlled solenoids, meters,...

Discrepancy switches use latest developments on Led technology increasing signal reliability and

remarkable for being maintenance free. Specific electronics permit multivoltage connection limiting the number of references required and simplifying panel designs and product logistics.

According to standards

- IEC 60947-3
- EN 60947-3
- IEC 61000

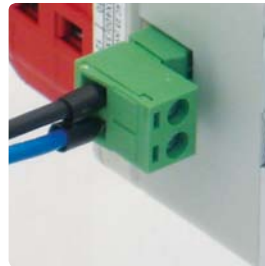
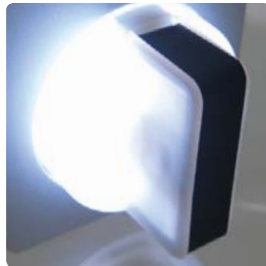

General characteristics

Combining electronic and electromechanic technology on this product has achieved a solution that distinguishes by its well achieved integration and its simple installation and operation.

- High luminosity low consumption multiled technology (100.000 hours live expectancy)
- Multivoltage 24-240VAC - 24-150VDC
- Vibration proof
- Polarity free easy connection by plug-in terminal blocks
- Encapsulated electronics. Maximum protection and safety.
- Simple mounting. Insert bolts on frontal breaking mechanism.
- Easy "push & click" front plate mounting

Applications



Rail transport industry



Medium voltage energy distribution

Mimic diagram

The association between discrepancy switch and disconnecter/circuit breaker is directly identified on the mimic diagram by the front plate shape.

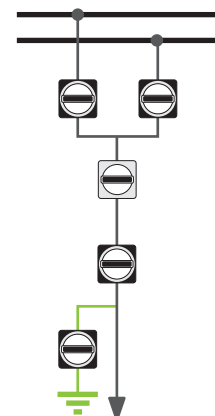

control discrepancy mimic diagram exemple

Operation

Control discrepancy

Discrepancy control switches have two fixed positions for pre-selection contacts at 90° and two additional impulse positions with 30° spring return.

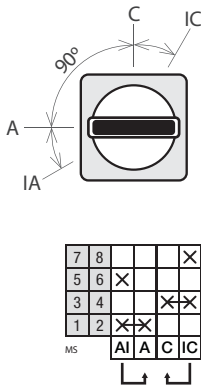

Discrepancy

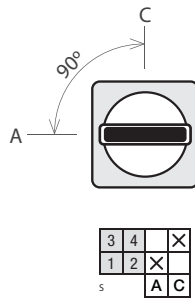

Push-turn control discrepancy

ES push-turn discrepancy control switches have two fixed positions for pre-selection contacts at 90° and two additional push-turn impulse positions with 30° spring return.

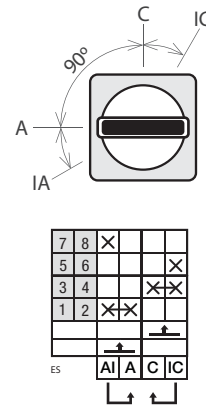

Dimensions and mounting

Control and discrepancy switches

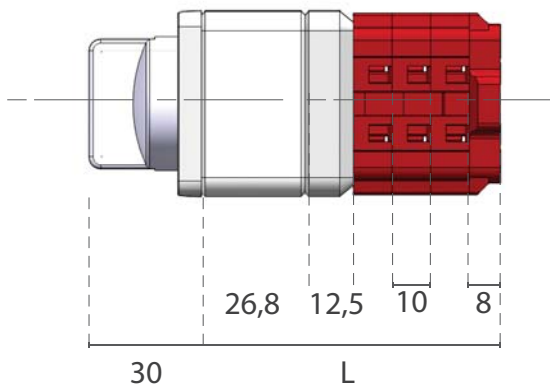

Push-turn control discrepancy switches

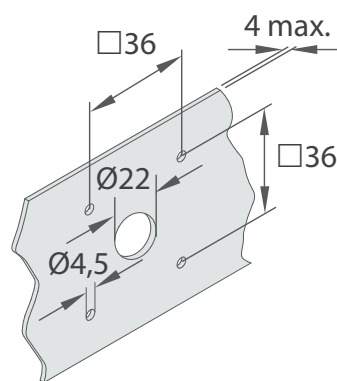
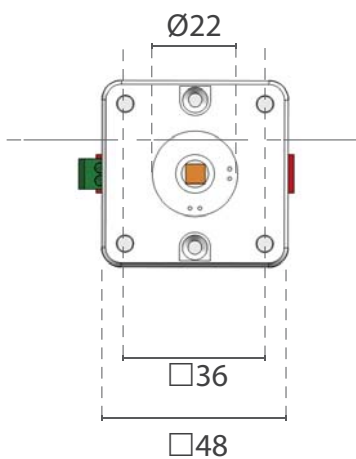
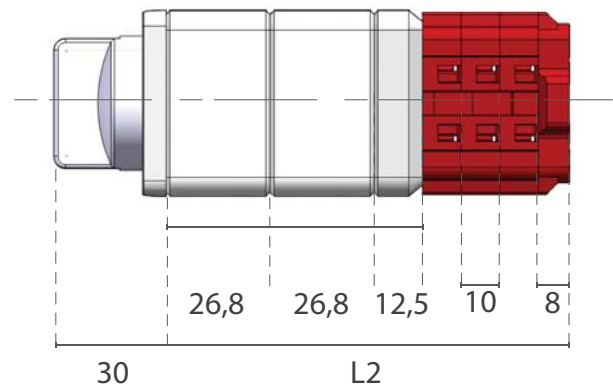

cells	1	2	3	4
L	57,3	67,3	77,3	87,3
L2	84,1	94,1	104,1	114,1

in mm.

References

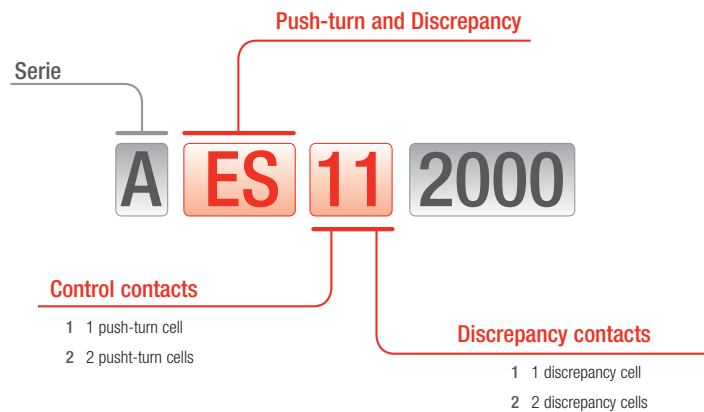
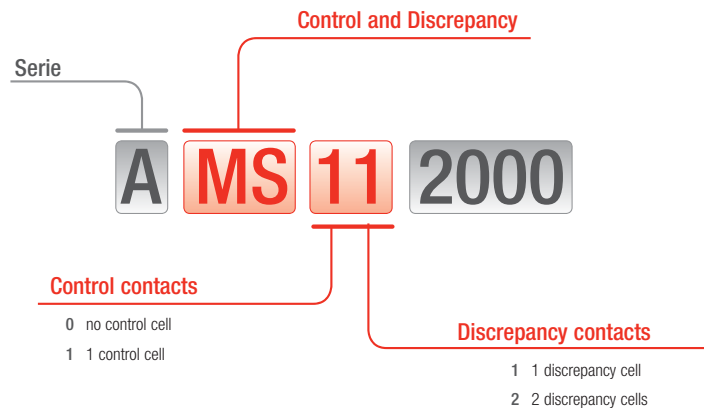

Switches

References	Type	In
AES112000	push-turn control and discrepancy	25 A
AES122000	push-turn control and discrepancy	25 A
AMS112000	control and discrepancy	25 A
AMS122000	control and discrepancy	25 A
AMS012000	discrepancy	25 A
AMS022000	discrepancy	25 A

Switches supplied without plate

Accessories

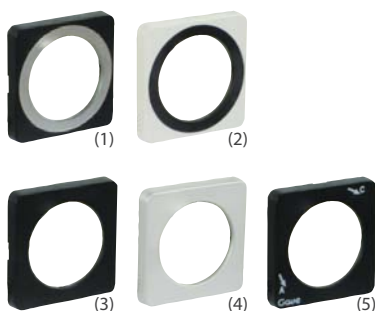

References	Description
AP326904-	black front plate with silver circle (picture 1)
AP327906-	grey front plate with black circle (picture 2)
AP325904-	square black front plate (picture 3)
AP325906-	square front plate silver (picture 4)
AP3289040	black front plate with inscription (picture 5)