

Multilayer ceramic capacitors

Leaded, X7R

Series/Type: **Leaded**

Date: February2009

The following products presented in this data sheet are being withdrawn.

Substitute Products: See www.epcos.com/withdrawal_mlcc

Ordering Code	Substitute Product	Date of Withdrawal	Deadline Last Orders	Last Shipments
B37987M0225K054		2009-06-26	2010-06-30	2010-12-31
B37987M0225K051		2009-06-26	2010-06-30	2010-12-31
B37987M0225K000		2009-06-26	2010-06-30	2010-12-31

© EPCOS AG 2009. Reproduction, publication and dissemination of this publication, enclosures hereto and the information contained therein without EPCOS' prior express consent is prohibited.



Ordering Code	Substitute Product	Date of Withdrawal	Deadline Last Orders	Last Shipments
B37987M5683K054		2009-06-26	2010-06-30	2010-12-31
B37987M5683K051		2009-06-26	2010-06-30	2010-12-31
B37987M5683K000		2009-06-26	2010-06-30	2010-12-31
B37987M5104K054		2009-06-26	2010-06-30	2010-12-31
B37987M5104K051		2009-06-26	2010-06-30	2010-12-31
B37987M5104K000		2009-06-26	2010-06-30	2010-12-31
B37987M5154K054		2009-06-26	2010-06-30	2010-12-31
B37987M5154K051		2009-06-26	2010-06-30	2010-12-31
B37987M5154K000		2009-06-26	2010-06-30	2010-12-31
B37981M5332K054		2009-06-26	2010-06-30	2010-12-31
B37981M5332K051		2009-06-26	2010-06-30	2010-12-31
B37987M5224K054		2009-06-26	2010-06-30	2010-12-31
B37987M5224K051		2009-06-26	2010-06-30	2010-12-31
B37987M5224K000		2009-06-26	2010-06-30	2010-12-31
B37987M5334K054		2009-06-26	2010-06-30	2010-12-31
B37987M5334K051		2009-06-26	2010-06-30	2010-12-31
B37981M5332K000		2009-06-26	2010-06-30	2010-12-31
B37981M5472K054		2009-06-26	2010-06-30	2010-12-31
B37981M5472K051		2009-06-26	2010-06-30	2010-12-31
B37981M5472K000		2009-06-26	2010-06-30	2010-12-31
B37981M5682K054		2009-06-26	2010-06-30	2010-12-31
B37987M5334K000		2009-06-26	2010-06-30	2010-12-31
B37987M5474K054		2009-06-26	2010-06-30	2010-12-31
B37987M5474K051		2009-06-26	2010-06-30	2010-12-31
B37987M5474K000		2009-06-26	2010-06-30	2010-12-31
B37987M1223K054		2009-06-26	2010-06-30	2010-12-31
B37981M5682K051		2009-06-26	2010-06-30	2010-12-31
B37981M5682K000		2009-06-26	2010-06-30	2010-12-31
B37981M5103K054		2009-06-26	2010-06-30	2010-12-31
B37981M5103K051		2009-06-26	2010-06-30	2010-12-31
B37987M1223K051		2009-06-26	2010-06-30	2010-12-31
B37987M1223K000		2009-06-26	2010-06-30	2010-12-31
B37987M1333K054		2009-06-26	2010-06-30	2010-12-31
B37987M1333K051		2009-06-26	2010-06-30	2010-12-31
B37987M1333K000		2009-06-26	2010-06-30	2010-12-31
B37987M1473K054		2009-06-26	2010-06-30	2010-12-31
B37987M1473K051		2009-06-26	2010-06-30	2010-12-31
B37987M1473K000		2009-06-26	2010-06-30	2010-12-31



Ordering Code	Substitute Product	Date of Withdrawal	Deadline Last Orders	Last Shipments
B37987M1683K054		2009-06-26	2010-06-30	2010-12-31
B37987M1683K051		2009-06-26	2010-06-30	2010-12-31
B37987F1683K000		2009-06-26	2010-06-30	2010-12-31
B37987F1104K054		2009-06-26	2010-06-30	2010-12-31
B37987F1104K051		2009-06-26	2010-06-30	2010-12-31
B37987F1104K000		2009-06-26	2010-06-30	2010-12-31
B37987F1154K054		2009-06-26	2010-06-30	2010-12-31
B37987F1154K051		2009-06-26	2010-06-30	2010-12-31
B37987F1154K000		2009-06-26	2010-06-30	2010-12-31
B37987F5683K054		2009-06-26	2010-06-30	2010-12-31
B37987F5683K051		2009-06-26	2010-06-30	2010-12-31
B37987F5683K000		2009-06-26	2010-06-30	2010-12-31
B37987F5104K054		2009-06-26	2010-06-30	2010-12-31
B37987F5104K051		2009-06-26	2010-06-30	2010-12-31
B37987F5104K000		2009-06-26	2010-06-30	2010-12-31
B37987F5154K054		2009-06-26	2010-06-30	2010-12-31
B37987F5154K051		2009-06-26	2010-06-30	2010-12-31
B37987F5154K000		2009-06-26	2010-06-30	2010-12-31
B37987F5224K054		2009-06-26	2010-06-30	2010-12-31
B37987F5224K051		2009-06-26	2010-06-30	2010-12-31
B37987F5224K000		2009-06-26	2010-06-30	2010-12-31
B37987F1223K054		2009-06-26	2010-06-30	2010-12-31
B37987F1223K051		2009-06-26	2010-06-30	2010-12-31
B37987F1223K000		2009-06-26	2010-06-30	2010-12-31
B37987F1333K054		2009-06-26	2010-06-30	2010-12-31
B37987F1333K051		2009-06-26	2010-06-30	2010-12-31
B37987F1333K000		2009-06-26	2010-06-30	2010-12-31
B37987F1473K054		2009-06-26	2010-06-30	2010-12-31
B37987F1473K051		2009-06-26	2010-06-30	2010-12-31
B37987F1473K000		2009-06-26	2010-06-30	2010-12-31
B37981M5103K000		2009-06-26	2010-06-30	2010-12-31
B37981M5153K054		2009-06-26	2010-06-30	2010-12-31
B37981M5153K051		2009-06-26	2010-06-30	2010-12-31
B37981M5153K000		2009-06-26	2010-06-30	2010-12-31
B37981M5223K054		2009-06-26	2010-06-30	2010-12-31
B37981M5223K051		2009-06-26	2010-06-30	2010-12-31
B37981M5223K000		2009-06-26	2010-06-30	2010-12-31
B37981M5333K054		2009-06-26	2010-06-30	2010-12-31



Ordering Code	Substitute Product	Date of Withdrawal	Deadline Last Orders	Last Shipments
B37981M5333K051		2009-06-26	2010-06-30	2010-12-31
B37981M5333K000		2009-06-26	2010-06-30	2010-12-31
B37987M1683K000		2009-06-26	2010-06-30	2010-12-31
B37987M1104K054		2009-06-26	2010-06-30	2010-12-31
B37987M1104K051		2009-06-26	2010-06-30	2010-12-31
B37987M1104K000		2009-06-26	2010-06-30	2010-12-31
B37987M1154K054		2009-06-26	2010-06-30	2010-12-31
B37981M5473K054		2009-06-26	2010-06-30	2010-12-31
B37981M5473K051		2009-06-26	2010-06-30	2010-12-31
B37981M5473K000		2009-06-26	2010-06-30	2010-12-31
B37981M5104K054		2009-06-26	2010-06-30	2010-12-31
B37981M5104K051		2009-06-26	2010-06-30	2010-12-31
B37987M1154K051		2009-06-26	2010-06-30	2010-12-31
B37987M1154K000		2009-06-26	2010-06-30	2010-12-31
B37981M5104K000		2009-06-26	2010-06-30	2010-12-31
B37981M1471K054		2009-06-26	2010-06-30	2010-12-31
B37981M1471K051		2009-06-26	2010-06-30	2010-12-31
B37981M1471K000		2009-06-26	2010-06-30	2010-12-31
B37981M1681K054		2009-06-26	2010-06-30	2010-12-31
B37981M1681K051		2009-06-26	2010-06-30	2010-12-31
B37981M1681K000		2009-06-26	2010-06-30	2010-12-31
B37981M1102K054		2009-06-26	2010-06-30	2010-12-31
B37981M1102K051		2009-06-26	2010-06-30	2010-12-31
B37981M1102K000		2009-06-26	2010-06-30	2010-12-31
B37981F5153K054		2009-06-26	2010-06-30	2010-12-31
B37981F5153K051		2009-06-26	2010-06-30	2010-12-31
B37981F5153K000		2009-06-26	2010-06-30	2010-12-31
B37981M1152K054		2009-06-26	2010-06-30	2010-12-31
B37981M1152K051		2009-06-26	2010-06-30	2010-12-31
B37981M1152K000		2009-06-26	2010-06-30	2010-12-31
B37981M1222K054		2009-06-26	2010-06-30	2010-12-31
B37981M1222K051		2009-06-26	2010-06-30	2010-12-31
B37981F5223K054		2009-06-26	2010-06-30	2010-12-31
B37981F5223K051		2009-06-26	2010-06-30	2010-12-31
B37981F5223K000		2009-06-26	2010-06-30	2010-12-31
B37981F5333K054		2009-06-26	2010-06-30	2010-12-31
B37981F5333K051		2009-06-26	2010-06-30	2010-12-31
B37981M1222K000		2009-06-26	2010-06-30	2010-12-31



Ordering Code	Substitute Product	Date of Withdrawal	Deadline Last Orders	Last Shipments
B37981M1332K054		2009-06-26	2010-06-30	2010-12-31
B37981M1332K051		2009-06-26	2010-06-30	2010-12-31
B37981M1332K000		2009-06-26	2010-06-30	2010-12-31
B37981M1472K054		2009-06-26	2010-06-30	2010-12-31
B37981F5333K000		2009-06-26	2010-06-30	2010-12-31
B37981F5473K054		2009-06-26	2010-06-30	2010-12-31
B37981F5473K051		2009-06-26	2010-06-30	2010-12-31
B37981F5473K000		2009-06-26	2010-06-30	2010-12-31
B37981F1471K054		2009-06-26	2010-06-30	2010-12-31
B37981M1472K051		2009-06-26	2010-06-30	2010-12-31
B37981M1472K000		2009-06-26	2010-06-30	2010-12-31
B37981M1682K054		2009-06-26	2010-06-30	2010-12-31
B37981M1682K051		2009-06-26	2010-06-30	2010-12-31
B37981M1682K000		2009-06-26	2010-06-30	2010-12-31
B37987F1683K054		2009-06-26	2010-06-30	2010-12-31
B37987F1683K051		2009-06-26	2010-06-30	2010-12-31
B37981F1471K051		2009-06-26	2010-06-30	2010-12-31
B37981F1471K000		2009-06-26	2010-06-30	2010-12-31
B37981F1681K054		2009-06-26	2010-06-30	2010-12-31
B37981F1681K051		2009-06-26	2010-06-30	2010-12-31
B37981F1681K000		2009-06-26	2010-06-30	2010-12-31
B37981M1103K054		2009-06-26	2010-06-30	2010-12-31
B37981M1103K051		2009-06-26	2010-06-30	2010-12-31
B37981M1103K000		2009-06-26	2010-06-30	2010-12-31
B37981M1153K054		2009-06-26	2010-06-30	2010-12-31
B37981M1153K051		2009-06-26	2010-06-30	2010-12-31
B37981F1102K054		2009-06-26	2010-06-30	2010-12-31
B37981F1102K051		2009-06-26	2010-06-30	2010-12-31
B37981F1102K000		2009-06-26	2010-06-30	2010-12-31
B37981F1152K054		2009-06-26	2010-06-30	2010-12-31
B37981F1152K051		2009-06-26	2010-06-30	2010-12-31
B37981M1153K000		2009-06-26	2010-06-30	2010-12-31
B37981F1152K000		2009-06-26	2010-06-30	2010-12-31
B37981F1222K054		2009-06-26	2010-06-30	2010-12-31
B37981F1222K051		2009-06-26	2010-06-30	2010-12-31
B37981F1222K000		2009-06-26	2010-06-30	2010-12-31
B37981F1332K054		2009-06-26	2010-06-30	2010-12-31
B37981F1332K051		2009-06-26	2010-06-30	2010-12-31



Ordering Code	Substitute Product	Date of Withdrawal	Deadline Last Orders	Last Shipments
B37981F1332K000		2009-06-26	2010-06-30	2010-12-31
B37981F1472K054		2009-06-26	2010-06-30	2010-12-31
B37981F1472K051		2009-06-26	2010-06-30	2010-12-31
B37981F1472K000		2009-06-26	2010-06-30	2010-12-31
B37981F1682K054		2009-06-26	2010-06-30	2010-12-31
B37981F1682K051		2009-06-26	2010-06-30	2010-12-31
B37981F1682K000		2009-06-26	2010-06-30	2010-12-31
B37981F1103K054		2009-06-26	2010-06-30	2010-12-31
B37981F1103K051		2009-06-26	2010-06-30	2010-12-31
B37981F1103K000		2009-06-26	2010-06-30	2010-12-31
B37981F1153K054		2009-06-26	2010-06-30	2010-12-31
B37981F1153K051		2009-06-26	2010-06-30	2010-12-31
B37981F1153K000		2009-06-26	2010-06-30	2010-12-31
B37981F5332K054		2009-06-26	2010-06-30	2010-12-31
B37981F5332K051		2009-06-26	2010-06-30	2010-12-31
B37981F5332K000		2009-06-26	2010-06-30	2010-12-31
B37981F5472K054		2009-06-26	2010-06-30	2010-12-31
B37981F5472K051		2009-06-26	2010-06-30	2010-12-31
B37981F5472K000		2009-06-26	2010-06-30	2010-12-31
B37981F5682K054		2009-06-26	2010-06-30	2010-12-31
B37981F5682K051		2009-06-26	2010-06-30	2010-12-31
B37981F5682K000		2009-06-26	2010-06-30	2010-12-31
B37981F5103K054		2009-06-26	2010-06-30	2010-12-31
B37981F5103K051		2009-06-26	2010-06-30	2010-12-31
B37981F5103K000		2009-06-26	2010-06-30	2010-12-31
B37984M5684K054		2009-06-26	2010-06-30	2010-12-31
B37984M5684K051		2009-06-26	2010-06-30	2010-12-31
B37984M5684K000		2009-06-26	2010-06-30	2010-12-31
B37984M5105K054		2009-06-26	2010-06-30	2010-12-31
B37984M5105K051		2009-06-26	2010-06-30	2010-12-31
B37984M5105K000		2009-06-26	2010-06-30	2010-12-31

For further information please contact your nearest EPCOS sales office, which will also support you in selecting a suitable substitute. The addresses of our worldwide sales network are presented at www.epcos.com/sales.

X7R

Ordering code system



B37981M		1	101	J	0	54																
Type and size <table border="1"> <thead> <tr> <th>With radial leads EIA standards</th> <th>Temperature characteristic X7R</th> </tr> </thead> <tbody> <tr> <td>Lead spacing 2.5 mm</td> <td></td> </tr> <tr> <td>5.5 × 5.0 × 2.5</td> <td>B37981M</td> </tr> <tr> <td>6.5 × 5.0 × 2.5</td> <td>B37987M</td> </tr> <tr> <td>Lead spacing 5.0 mm</td> <td></td> </tr> <tr> <td>5.5 × 5.0 × 2.5</td> <td>B37981F</td> </tr> <tr> <td>6.5 × 5.0 × 2.5</td> <td>B37987F</td> </tr> <tr> <td>9.0 × 7.5 × 2.5</td> <td>B37984M</td> </tr> </tbody> </table>		With radial leads EIA standards	Temperature characteristic X7R	Lead spacing 2.5 mm		5.5 × 5.0 × 2.5	B37981M	6.5 × 5.0 × 2.5	B37987M	Lead spacing 5.0 mm		5.5 × 5.0 × 2.5	B37981F	6.5 × 5.0 × 2.5	B37987F	9.0 × 7.5 × 2.5	B37984M					
With radial leads EIA standards	Temperature characteristic X7R																					
Lead spacing 2.5 mm																						
5.5 × 5.0 × 2.5	B37981M																					
6.5 × 5.0 × 2.5	B37987M																					
Lead spacing 5.0 mm																						
5.5 × 5.0 × 2.5	B37981F																					
6.5 × 5.0 × 2.5	B37987F																					
9.0 × 7.5 × 2.5	B37984M																					
Rated voltage 5 (Code) \triangleq 50 VDC 1 (Code) \triangleq 100 VDC																						
Capacitance, coded (example) 101 \triangleq 10 · 10 ¹ pF = 100 pF 222 \triangleq 22 · 10 ² pF = 2.2 nF 473 \triangleq 47 · 10 ³ pF = 47 nF																						
Capacitance tolerance K \triangleq \pm 10% (standard for X7R) M \triangleq \pm 20%																						
Internal coding																						
Packaging 51 \triangleq cardboard tape, reel packing (360-mm reel) 54 \triangleq Ammo packing (standard) 00 \triangleq bulk																						

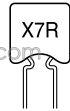

Features

- High volumetric efficiency
- Non-linear capacitance change
- High insulation resistance
- High pulse strength

Applications

- Blocking
- Coupling and decoupling
- Interference suppression

Termination

- Parallel wire leads, iron-nickel, tinned
- Crimped leads
- Non-standard lead lengths on request

Marking

- Rated capacitance, tolerance, manufacturer's logo, ceramic material, voltage

Options

- Alternative capacitance values and tolerances available on request

Delivery mode

- Cardboard tape in Ammo packing (standard)
- Cardboard tape on 360-mm reel or bulk on request

Electrical data

Temperature characteristic			X7R	
Max. relative capacitance change	within $-55 \dots +125 \text{ }^\circ\text{C}$	$\Delta\text{C}/\text{C}$	± 15	%
Climatic category	(IEC 60068-1)		55/125/56	
Standard			EIA	
Dielectric			Class 2	
Rated voltage ¹⁾		V_R	50, 100	VDC
Test voltage		V_{rest}	$2.5 \cdot V_R/5 \text{ s}$	VDC
Capacitance range / E series		C_R	470 pF ... 1 μF	
Dissipation factor	(limit value)	$\tan \delta$	$< 25 \cdot 10^{-3}$	
Insulation resistance ²⁾	(at $+25 \text{ }^\circ\text{C}$)	R_{ins}	$> 10^5$	M Ω
Insulation resistance ²⁾	(at $+125 \text{ }^\circ\text{C}$)	R_{ins}	$> 10^4$	M Ω
Time constant ²⁾	(at $+25 \text{ }^\circ\text{C}$)	τ	> 1000	s
Time constant ²⁾	(at $+125 \text{ }^\circ\text{C}$)	τ	> 100	s
Operating temperature range		T_{op}	$-55 \dots +125$	$^\circ\text{C}$
Ageing ³⁾			yes	

1) Note: No operation on AC line.

2) For $C_R \geq 10 \text{ nF}$ the time constant $\tau = C \cdot R_{\text{ins}}$ is given.

3) Refer to chapter "General technical information", "Ageing".

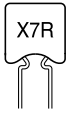

Multilayer ceramic capacitors

X7R

www.DataSheet4U.com

Capacity tolerance

Code letter	K (standard)	M
Tolerance	±10 %	±20 %

Dimensional drawing

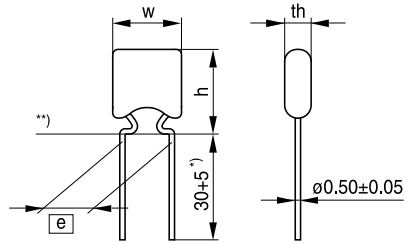





^{*)} Lead length for bulk packaging

^{**)} Seating plane to IEC 600717

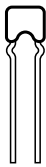
KKE0456-R-E

Dimensions (mm)

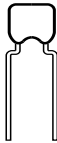
	Lead spacing $e = 2.5 +0.6/-0.1$ mm	
Type	B37981M	B37987M
		
h_{max}	5.5	6.0
w_{max}	5.0	5.0
th_{max}	2.5	2.5

	Lead spacing $e = 5.0 +0.6/-0.1$ mm		
Type	B37981F	B37987F	B37984M
			
h_{max}	5.5	6.5	9.0
w_{max}	5.0	5.0	7.5
th_{max}	2.5	2.5	2.5

Termination

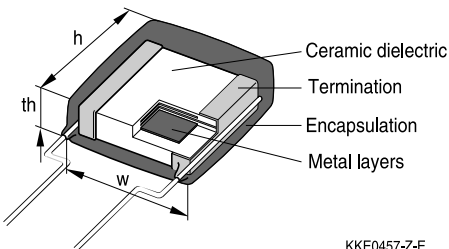

KKE0457-Z-E

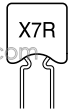

Product range for leaded capacitors, X7R

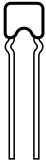
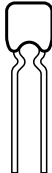
Lead spacing	2.5 mm				
					
h x w x th	5.5 × 5.0 × 2.5		6.5 × 5.0 × 2.5		
Type	B37981M		B37987M		
C _R \ V _R (VDC)	50	100	25	50	100
470 pF					
680 pF					
1.0 nF					
1.5 nF					
2.2 nF					
3.3 nF					
4.7 nF					
6.8 nF					
10 nF					
15 nF					
22 nF					
33 nF					
47 nF					
68 nF					
100 nF					
150 nF					
220 nF					
330 nF					
470 nF					
2.2 μF					

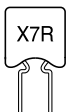
Product range for leaded capacitors, X7R

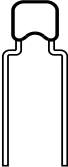
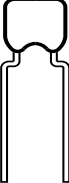
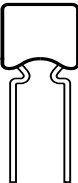
Lead spacing	5.0 mm				
					
h x w x th	5.5 × 5.0 × 2.5		6.5 × 5.0 × 2.5		9.0 × 7.5 × 2.5
Type	B37981F		B37987F		B37984M
$C_R \setminus V_R$ (VDC)	50	100	50	100	50
470 pF					
680 pF					
1.0 nF					
1.5 nF					
2.2 nF					
3.3 nF					
4.7 nF					
6.8 nF					
10 nF					
15 nF					
22 nF					
33 nF					
47 nF					
68 nF					
100 nF					
150 nF					
220 nF					
680 nF					
1.0 μF					

Ordering codes and packing for X7R, 25 VDC, lead spacing 2.5 mm

C_R	Ordering code	Ammo packing	Reel packing	Bulk
		** \triangle 54	** \triangle 51	** \triangle 00
	pcs.	pcs./reel	pcs.	

B37987M, 25 VDC

2.2 μF	B37987M0225K0**	2500	2500	2000
--------	-----------------	------	------	------

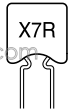
Ordering codes and packing for X7R, 50 VDC, lead spacing 2.5 mm

C _R	Ordering code	Ammo packing	Reel packing	Bulk
		** \triangle 54	** \triangle 51	** \triangle 00
		pcs.	pcs./reel	pcs.
B37981M, 50 VDC				
3.3 nF	B37981M5332K0**	2500	2500	2000
4.7 nF	B37981M5472K0**	2500	2500	2000
6.8 nF	B37981M5682K0**	2500	2500	2000
10 nF	B37981M5103K0**	2500	2500	2000
15 nF	B37981M5153K0**	2500	2500	2000
22 nF	B37981M5223K0**	2500	2500	2000
33 nF	B37981M5333K0**	2500	2500	2000
47 nF	B37981M5473K0**	2500	2500	2000
100 nF	B37981M5104K0**	2500	2500	2000

B37987M, 50 VDC

68 nF	B37987M5683K0**	2500	2500	2000
100 nF	B37987M5104K0**	2500	2500	2000
150 nF	B37987M5154K0**	2500	2500	2000
220 nF	B37987M5224K0**	2500	2500	2000
330 nF	B37987M5334K0**	2500	2500	2000
470 nF	B37987M5474K0**	2500	2500	2000

Ordering codes and packing for X7R, 50 VDC, lead spacing 5.0 mm

C _R	Ordering code	Ammo packing	Reel packing	Bulk
		** \triangle 54	** \triangle 51	** \triangle 00
		pcs.	pcs./reel	pcs.
B37981F, 50 VDC				
3.3 nF	B37981F5332K0**	2500	2500	2000
4.7 nF	B37981F5472K0**	2500	2500	2000
6.8 nF	B37981F5682K0**	2500	2500	2000
10 nF	B37981F5103K0**	2500	2500	2000
15 nF	B37981F5153K0**	2500	2500	2000
22 nF	B37981F5223K0**	2500	2500	2000
33 nF	B37981F5333K0**	2500	2500	2000
47 nF	B37981F5473K0**	2500	2500	2000

B37984M, 50 VDC

680 nF	B37984M5684K0**	2000	2000	2000
1.0 μ F	B37984M5105K0**	2000	2000	2000

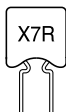
Multilayer ceramic capacitors
www.DataSheet4U.com
X7R
Ordering codes and packing for X7R, 50 VDC, lead spacing 5.0 mm

C _R	Ordering code	Ammo packing	Reel packing	Bulk
		** \triangle 54	** \triangle 51	** \triangle 00
		pcs.	pcs./reel	pcs.

B37987F, 50 VDC

68 nF	B37987F5683K0**	2500	2500	2000
100 nF	B37987F5104K0**	2500	2500	2000
150 nF	B37987F5154K0**	2500	2500	2000
220 nF	B37987F5224K0**	2500	2500	2000

Ordering codes and packing for X7R, 100 VDC, lead spacing 2.5 mm

C _R	Ordering code	Ammo packing	Reel packing	Bulk
		** \triangle 54	** \triangle 51	** \triangle 00
		pcs.	pcs./reel	pcs.

B37981M, 100 VDC

470 pF	B37981M1471K0**	2500	2500	2000
680 pF	B37981M1681K0**	2500	2500	2000
1.0 nF	B37981M1102K0**	2500	2500	2000
1.5 nF	B37981M1152K0**	2500	2500	2000
2.2 nF	B37981M1222K0**	2500	2500	2000
3.3 nF	B37981M1332K0**	2500	2500	2000
4.7 nF	B37981M1472K0**	2500	2500	2000
6.8 nF	B37981M1682K0**	2500	2500	2000
10 nF	B37981M1103K0**	2500	2500	2000
15 nF	B37981M1153K0**	2500	2500	2000

B37987M, 100 VDC

22 nF	B37987M1223K0**	2500	2500	2000
33 nF	B37987M1333K0**	2500	2500	2000
47 nF	B37987M1473K0**	2500	2500	2000
68 nF	B37987M1683K0**	2500	2500	2000
100 nF	B37987M1104K0**	2500	2500	2000
150 nF	B37987M1154K0**	2500	2500	2000

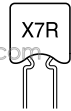

Ordering codes and packing for X7R, 100 VDC, lead spacing 5.0 mm

C _R	Ordering code	Ammo packing	Reel packing	Bulk
		** \triangle 54	** \triangle 51	** \triangle 00
		pcs.	pcs./reel	pcs.

B37981F, 100 VDC

470 pF	B37981F1471K0**	2500	2500	2000
680 pF	B37981F1681K0**	2500	2500	2000
1.0 nF	B37981F1102K0**	2500	2500	2000
1.5 nF	B37981F1152K0**	2500	2500	2000
2.2 nF	B37981F1222K0**	2500	2500	2000
3.3 nF	B37981F1332K0**	2500	2500	2000
4.7 nF	B37981F1472K0**	2500	2500	2000
6.8 nF	B37981F1682K0**	2500	2500	2000
10 nF	B37981F1103K0**	2500	2500	2000
15 nF	B37981F1153K0**	2500	2500	2000

B37987F, 100 VDC

22 nF	B37987F1223K0**	2500	2500	2000
33 nF	B37987F1333K0**	2500	2500	2000
47 nF	B37987F1473K0**	2500	2500	2000
68 nF	B37987F1683K0**	2500	2500	2000
100 nF	B37987F1104K0**	2500	2500	2000
150 nF	B37987F1154K0**	2500	2500	2000

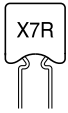

Typical characteristics

Capacitance change $\Delta C/C_{25}$ versus temperature T

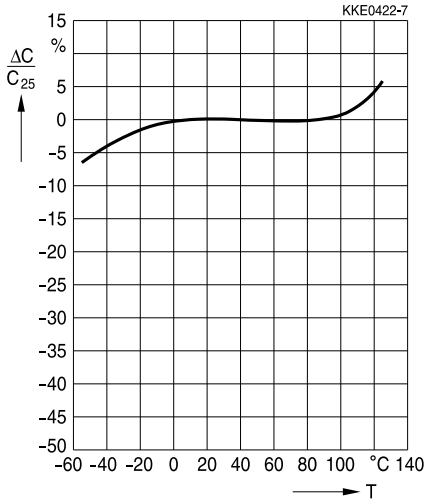

Capacitance change $\Delta C/C_0$ versus superimposed DC voltage V

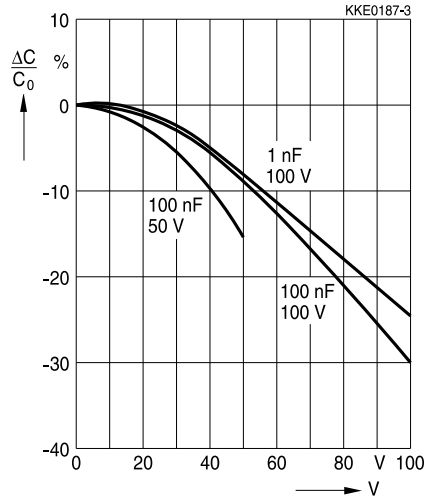

Insulation resistance R_{ins} versus temperature T

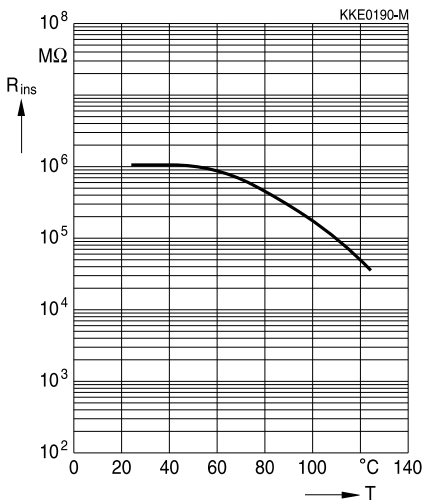

Dissipation factor $\tan \delta$ versus temperature T

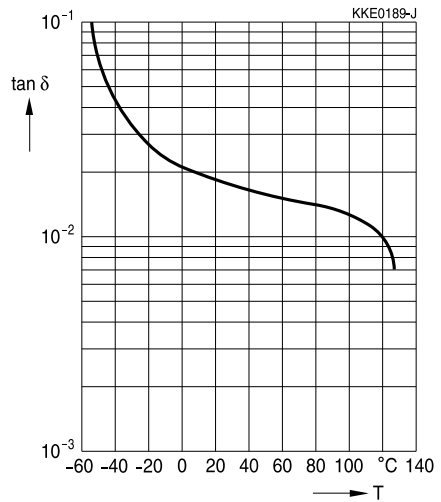

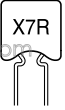

Typical characteristics

Impedance $|Z|$ versus frequency f

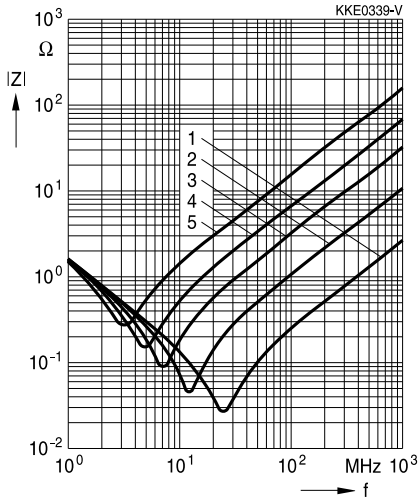

- 1: SMD chip capacitor
- 2: 1.5 mm lead length
- 3: 5.0 mm lead length
- 4: 10.0 mm lead length
- 5: 20.0 mm lead length

Capacitance change $\Delta C/C_1$ versus time t

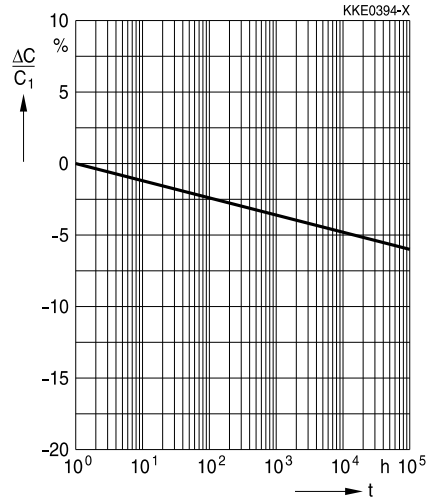

The following applies to all products named in this publication:

1. Some parts of this publication contain **statements about the suitability of our products for certain areas of application**. These statements are based on our knowledge of typical requirements that are often placed on our products in the areas of application concerned. We nevertheless expressly point out **that such statements cannot be regarded as binding statements about the suitability of our products for a particular customer application**. As a rule, EPCOS is either unfamiliar with individual customer applications or less familiar with them than the customers themselves. For these reasons, it is always ultimately incumbent on the customer to check and decide whether an EPCOS product with the properties described in the product specification is suitable for use in a particular customer application.
2. We also point out that **in individual cases, a malfunction of electronic components or failure before the end of their usual service life cannot be completely ruled out in the current state of the art, even if they are operated as specified**. In customer applications requiring a very high level of operational safety and especially in customer applications in which the malfunction or failure of an electronic component could endanger human life or health (e.g. in accident prevention or lifesaving systems), it must therefore be ensured by means of suitable design of the customer application or other action taken by the customer (e.g. installation of protective circuitry or redundancy) that no injury or damage is sustained by third parties in the event of malfunction or failure of an electronic component.
3. **The warnings, cautions and product-specific notes must be observed**.
4. In order to satisfy certain technical requirements, **some of the products described in this publication may contain substances subject to restrictions in certain jurisdictions (e.g. because they are classed as hazardous)**. Useful information on this will be found in our Material Data Sheets on the Internet (www.epcos.com/material). Should you have any more detailed questions, please contact our sales offices.
5. We constantly strive to improve our products. Consequently, **the products described in this publication may change from time to time**. The same is true of the corresponding product specifications. Please check therefore to what extent product descriptions and specifications contained in this publication are still applicable before or when you place an order. We also **reserve the right to discontinue production and delivery of products**. Consequently, we cannot guarantee that all products named in this publication will always be available. The aforementioned does not apply in the case of individual agreements deviating from the foregoing for customer-specific products.
6. Unless otherwise agreed in individual contracts, **all orders are subject to the current version of the "General Terms of Delivery for Products and Services in the Electrical Industry" published by the German Electrical and Electronics Industry Association (ZVEI)**.
7. The trade names EPCOS, BAOKE, Alu-X, CeraDiode, CSMP, CSSP, CTVS, DSSP, MiniBlue, MKK, MLSC, MotorCap, PCC, PhaseCap, PhaseCube, PhaseMod, SIFERRIT, SIFI, SIKOREL, SilverCap, SIMDAD, SIMID, SineFormer, SIOV, SIP5D, SIP5K, ThermoFuse, WindCap are **trademarks registered or pending** in Europe and in other countries. Further information will be found on the Internet at www.epcos.com/trademarks.