

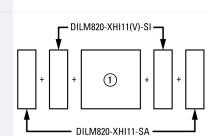

Contactor, 380 V 400 V 132 kW, 2 N/O, 2 NC, 220 - 240 V 50/60 Hz, AC operation, Screw connection

Part no. DILM250-S/22(220-240V50/60HZ)
Catalog No. 274190
Alternate Catalog No. XTCS250L22B
EL-Nummer (Norway) 4110261

Delivery program

Product range			Contactors
Application			Contactors for Motors
Subrange			Standard devices greater than 170 A
Utilization category			AC-1: Non-inductive or slightly inductive loads, resistance furnaces NAC-3: Normal AC induction motors: starting, switch off during running AC-4: Normal AC induction motors: starting, plugging, reversing, inching
Connection technique			Screw connection
Rated operational current			
AC-3			
380 V 400 V	I_e	A	250
AC-1			
Conventional free air thermal current, 3 pole, 50 - 60 Hz			
Open			
at 40 °C	$I_{th} = I_e$	A	430
enclosed	I_{th}	A	300
Conventional free air thermal current, 1 pole			
open	I_{th}	A	875
enclosed	I_{th}	A	750
Max. rating for three-phase motors, 50 - 60 Hz			
AC-3			
220 V 230 V	P	kW	75
380 V 400 V	P	kW	132
660 V 690 V	P	kW	170
1000 V	P	kW	108
AC-4			
220 V 230 V	P	kW	62
380 V 400 V	P	kW	110
660 V 690 V	P	kW	137
1000 V	P	kW	108
Contact sequence			
Can be combined with auxiliary contact			DILM820-XHI...
Actuating voltage			220 - 240 V 50/60 Hz
Voltage AC/DC			AC operation
Contacts			
N/O = Normally open			2 N/O
N/C = Normally closed			2 NC
Auxiliary contacts			
possible variants at auxiliary contact module fitting options			on the side: 2 x DILM820-XHI11(V)-SI; 2 x DILM820-XHI11-SA
Side mounting auxiliary contacts			
Instructions			Interlocked opposing contacts according to IEC/EN 60947-5-1 Appendix L, inside the auxiliary contact module

Auxiliary contacts used as mirror contacts according to IEC/EN 60947-4-1 Appendix F (not N/C late open)

Instructions

integrated suppressor circuit in actuating electronics
660 V, 690 V or 1000 V: not directly reversing

Notes

DILM...-S power contactors are actuated traditionally

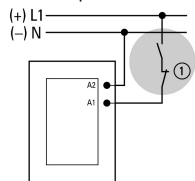

① Stopping in the event of an emergency (emergency switching off)

Technical data

General

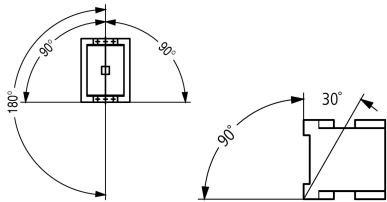
Standards			IEC/EN 60947, VDE 0660, UL, CSA
Lifespan, mechanical			
AC operated	Operations	$\times 10^6$	10
Operating frequency, mechanical			
AC operated	Operations/h		3000
Climatic proofing			Damp heat, constant, to IEC 60068-2-78 Damp heat, cyclic, to IEC 60068-2-30
Ambient temperature			
Open		°C	-40 - +60
Enclosed		°C	-40 - +40
Storage		°C	-40 - +80
Mounting position			
Mechanical shock resistance (IEC/EN 60068-2-27)			
Half-sinusoidal shock, 10 ms			
Main contacts			
N/O contact		g	10
Auxiliary contacts			
N/O contact		g	10
N/C contact		g	8
Degree of Protection			IP00
Protection against direct contact when actuated from front (EN 50274)			Finger and back-of-hand proof with terminal shroud or terminal block
Altitude		m	Max. 2000
Weight			
AC operated		kg	6.71
DC operated		kg	6.71
Weight		kg	6.71
Terminal capacity main cable			
Flexible with cable lug		mm ²	50 - 240
Stranded with cable lug		mm ²	70 - 240
Solid or stranded		AWG	2/0 - 500 MCM
Flat conductor	Lamellenzahl x Breite x Dicke	mm	Fixing with flat cable terminal or cable terminal blocks See terminal capacity for cable terminal blocks
Busbar	Width	mm	25
Main cable connection screw/bolt			M10
Tightening torque		Nm	24
Terminal capacity control circuit cables			
Solid		mm ²	1 x (0.75 - 2.5) 2 x (0.75 - 2.5)

Flexible with ferrule		mm ²	1 x (0.75 - 2.5) 2 x (0.75 - 2.5)
Solid or stranded		AWG	18 - 14
Control circuit cable connection screw/bolt			M3.5
Tightening torque		Nm	1.2
Tool			
Main cable			
Width across flats		mm	16
Control circuit cables			
Pozidriv screwdriver		Size	2

Main conducting paths

Rated impulse withstand voltage	U_{imp}	V AC	8000
Overvoltage category/pollution degree			III/3
Rated insulation voltage	U_i	V AC	1000
Rated operational voltage	U_e	V AC	1000
Safe isolation to EN 61140			
between coil and contacts		V AC	500
between the contacts		V AC	500
Making capacity (p.f. to IEC/EN 60947)		A	3000
Breaking capacity			
220 V 230 V		A	2500
380 V 400 V		A	2500
500 V		A	2500
660 V 690 V		A	2500
1000 V		A	760
Component lifespan			AC1: See → Engineering, characteristic curves AC3: See → Engineering, characteristic curves AC4: See → Engineering, characteristic curves
Short-circuit rating			
Short-circuit protection maximum fuse			
Type "2" coordination			
400 V	gG/gL 500 V	A	400
690 V	gG/gL 690 V	A	315
1000 V	gG/gL 1000 V	A	160
Type "1" coordination			
400 V	gG/gL 500 V	A	400
690 V	gG/gL 690 V	A	400
1000 V	gG/gL 1000 V	A	200

AC

AC-1			
Rated operational current			
Conventional free air thermal current, 3 pole, 50 - 60 Hz			
Open			
at 40 °C	$I_{th} = I_e$	A	430
at 50 °C	$I_{th} = I_e$	A	380
at 55 °C	$I_{th} = I_e$	A	365
at 60 °C	$I_{th} = I_e$	A	350
enclosed	I_{th}	A	300
Notes			At maximum permissible ambient air temperature.
Conventional free air thermal current, 1 pole			
Note			at maximum permissible ambient air temperature
open	I_{th}	A	875
enclosed	I_{th}	A	750
AC-3			
Rated operational current			

Open, 3-pole: 50 – 60 Hz			
Notes			At maximum permissible ambient temperature (open.)
220 V 230 V	I_e	A	250
240 V	I_e	A	250
380 V 400 V	I_e	A	250
415 V	I_e	A	250
440V	I_e	A	250
500 V	I_e	A	250
660 V 690 V	I_e	A	185
1000 V	I_e	A	76
Motor rating	P	kWh	
220 V 230 V	P	kW	75
240V	P	kW	85
380 V 400 V	P	kW	132
415 V	P	kW	143
440 V	P	kW	152
500 V	P	kW	173
660 V 690 V	P	kW	170
1000 V	P	kW	108
AC-4			
Rated operational current			
Open, 3-pole: 50 – 60 Hz			
220 V 230 V	I_e	A	200
240 V	I_e	A	200
380 V 400 V	I_e	A	200
415 V	I_e	A	200
440 V	I_e	A	200
500 V	I_e	A	200
660 V 690 V	I_e	A	150
1000 V	I_e	A	76
Motor rating	P	kWh	
220 V 230 V	P	kW	62
240 V	P	kW	68
380 V 400 V	P	kW	110
415 V	P	kW	117
440 V	P	kW	125
500 V	P	kW	138
660 V 690 V	P	kW	137
1000 V	P	kW	108
Condensator operation			
Individual compensation, rated operational current I_e of three-phase capacitors			
Open			
up to 525 V		A	220
690 V		A	133
Max. inrush current peak		$\times I_e$	30
Component lifespan	Operations	$\times 10^6$	0.1
Max. operating frequency		Ops/h	200
DC			
Rated operational current, open			
DC-1			
Notes			see DILDC300/DILDC600 or on request
Current heat loss			
3 pole, at I_{th} (60°)		W	55
Current heat loss at I_e to AC-3/400 V		W	28

Impedance per pole		mΩ	0.15
Magnet systems			
Voltage tolerance			
U _S			220 - 240 V 50/60 Hz
AC operated	Pick-up		0.85 x U _{S min} - 1.1 x U _{S max}
AC operated	Drop-out		0.2 x U _{S min} - 0.4 x U _{S max}
Power consumption of the coil in a cold state and 1.0 x U _S			
Note on power consumption			Control transformer with u _k ≤ 10%
Pull-in power	Pick-up	VA	360
Pull-in power	Pick-up	W	325
Sealing power	Sealing	VA	7.3
Sealing power	Sealing	W	4.8
Duty factor		% DF	100
Changeover time at 100 % U _S (recommended value)			
Main contacts			
Closing delay		ms	55
Opening delay		ms	40
Behaviour in marginal and transitional conditions			
Sealing			
Voltage interruptions			
(0 ... 0.2 x U _{C min}) ≤ 10 ms			Time is bridged successfully
(0 ... 0.2 x U _{C min}) > 10 ms			Drop-out of the contactor
Voltage drops			
(0.2 ... 0.6 x U _{C min}) ≤ 12 ms			Time is bridged successfully
(0.2 ... 0.6 x U _{C min}) > 12 ms			Drop-out of the contactor
(0.6 ... 0.7 x U _{C min})			Contactor remains switched on
Excess voltage			
(1.15 ... 1.3 x U _{C max})			Contactor remains switched on
Pick-up phase			
(0 ... 0.7 x U _{C min})			Contactor does not switch on
(0.7 x U _{C min} ... 1.15 x U _{C max})			Contactor switches on with certainty
Admissible transitional contact resistance (of the external control circuit device when actuating A11)		mΩ	≤ 500

Electromagnetic compatibility (EMC)

Electromagnetic compatibility			This product is designed for operation in industrial environments (environment A). Its use in residential environments (environment B) may cause radio-frequency interference, requiring additional noise suppression measures.
-------------------------------	--	--	---

Rating data for approved types

Switching capacity			
Maximum motor rating			
Three-phase			
200 V 208 V		HP	75
230 V 240 V		HP	100
460 V 480 V		HP	200
575 V 600 V		HP	250
General use		A	350
Auxiliary contacts			
Pilot Duty			
AC operated			A600
DC operated			P300
General Use			
AC		V	600
AC		A	15
DC		V	250

DC	A	1
Short Circuit Current Rating	SCCR	
Basic Rating		
SCCR	kA	18
max. Fuse	A	700
max. CB	A	600
480 V High Fault		
SCCR (fuse)	kA	18
max. Fuse	A	700 Class L
SCCR (CB)	kA	65
max. CB	A	250
600 V High Fault		
SCCR (fuse)	kA	18
max. Fuse	A	700 Class J
SCCR (CB)	kA	18
max. CB	A	600
Special Purpose Ratings		
Definite Purpose Ratings (100,000 cycles acc. to UL 1995)		
LRA 480V 60Hz 3phase	A	2050
FLA 480V 60Hz 3phase	A	300
LRA 600V 60Hz 3phase	A	1800
FLA 600V 60Hz 3phase	A	250

Design verification as per IEC/EN 61439

Technical data for design verification			
Rated operational current for specified heat dissipation	I_n	A	250
Heat dissipation per pole, current-dependent	P_{vid}	W	9.33
Equipment heat dissipation, current-dependent	P_{vid}	W	0
Static heat dissipation, non-current-dependent	P_{vs}	W	4.8
Heat dissipation capacity	P_{diss}	W	0
Operating ambient temperature min.		°C	-40
Operating ambient temperature max.		°C	60
IEC/EN 61439 design verification			
10.2 Strength of materials and parts			
10.2.2 Corrosion resistance			
			Meets the product standard's requirements.
10.2.3.1 Verification of thermal stability of enclosures			
			Meets the product standard's requirements.
10.2.3.2 Verification of resistance of insulating materials to normal heat			
			Meets the product standard's requirements.
10.2.3.3 Verification of resistance of insulating materials to abnormal heat and fire due to internal electric effects			
			Meets the product standard's requirements.
10.2.4 Resistance to ultra-violet (UV) radiation			
			Meets the product standard's requirements.
10.2.5 Lifting			
			Does not apply, since the entire switchgear needs to be evaluated.
10.2.6 Mechanical impact			
			Does not apply, since the entire switchgear needs to be evaluated.
10.2.7 Inscriptions			
			Meets the product standard's requirements.
10.3 Degree of protection of ASSEMBLIES			
			Does not apply, since the entire switchgear needs to be evaluated.
10.4 Clearances and creepage distances			
			Meets the product standard's requirements.
10.5 Protection against electric shock			
			Does not apply, since the entire switchgear needs to be evaluated.
10.6 Incorporation of switching devices and components			
			Does not apply, since the entire switchgear needs to be evaluated.
10.7 Internal electrical circuits and connections			
			Is the panel builder's responsibility.
10.8 Connections for external conductors			
			Is the panel builder's responsibility.
10.9 Insulation properties			
10.9.2 Power-frequency electric strength			
			Is the panel builder's responsibility.
10.9.3 Impulse withstand voltage			
			Is the panel builder's responsibility.
10.9.4 Testing of enclosures made of insulating material			
			Is the panel builder's responsibility.
10.10 Temperature rise			
			The panel builder is responsible for the temperature rise calculation. Eaton will provide heat dissipation data for the devices.

10.11 Short-circuit rating		Is the panel builder's responsibility. The specifications for the switchgear must be observed.
10.12 Electromagnetic compatibility		Is the panel builder's responsibility. The specifications for the switchgear must be observed.
10.13 Mechanical function		The device meets the requirements, provided the information in the instruction leaflet (IL) is observed.

Technical data ETIM 7.0

Low-voltage industrial components (EG000017) / Power contactor, AC switching (EC000066)		
Electric engineering, automation, process control engineering / Low-voltage switch technology / Contactor (LV) / Power contactor, AC switching (ecl@ss10.0.1-27-37-10-03 [AAB718015])		
Rated control supply voltage Us at AC 50HZ	V	220 - 240
Rated control supply voltage Us at AC 60HZ	V	220 - 240
Rated control supply voltage Us at DC	V	0 - 0
Voltage type for actuating		AC
Rated operation current Ie at AC-1, 400 V	A	429
Rated operation current Ie at AC-3, 400 V	A	250
Rated operation power at AC-3, 400 V	kW	132
Rated operation current Ie at AC-4, 400 V	A	200
Rated operation power at AC-4, 400 V	kW	110
Rated operation power NEMA	kW	149
Modular version		No
Number of auxiliary contacts as normally open contact		2
Number of auxiliary contacts as normally closed contact		2
Type of electrical connection of main circuit		Screw connection
Number of normally closed contacts as main contact		0
Number of main contacts as normally open contact		3

Approvals

Product Standards		IEC/EN 60947-4-1; UL 60947-4-1; CSA - C22.2 No. 60947-4-1-14; CE marking
UL File No.		E29096
UL Category Control No.		NLDX
CSA File No.		1017510
CSA Class No.		3211-04
North America Certification		UL listed, CSA certified
Specially designed for North America		No

Characteristics

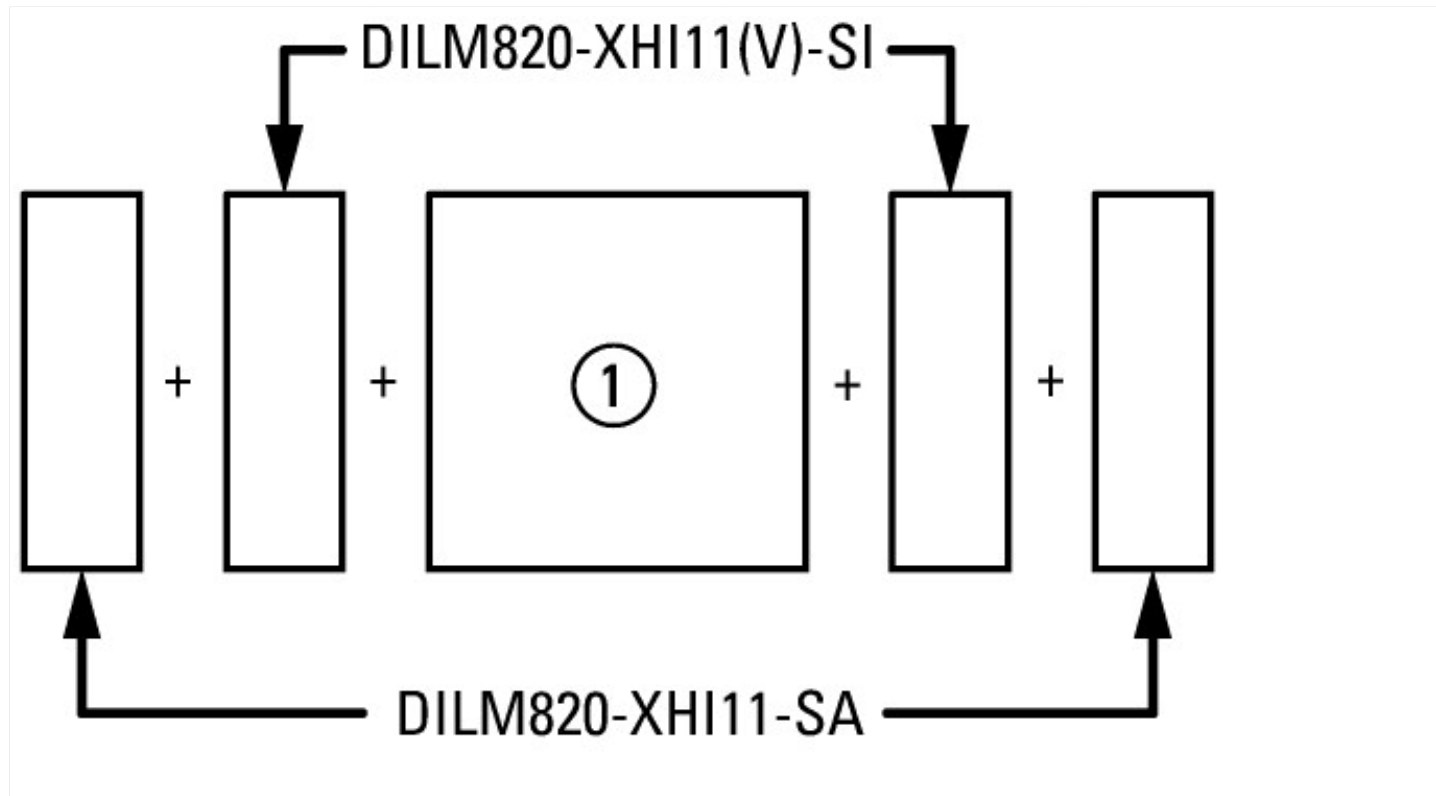

on the side: 2 x DILM820-XHI11(V)-SI; 2 x DILM820-XHI11-SA



Normal switching duty
 Normal AC induction motor
 Operating characteristics
 Switch on: from stop
 Switch off: during run
 Electrical characteristics:
 Switch on: up to 6 x Rated motor current
 Switch off: up to 1 x Rated motor current
 Utility category
 100 % AC-3
 Typical Applications
 Compressors
 Lifts
 Mixers
 Pumps
 Escalators
 Agitators
 fan
 Conveyor belts
 Centrifuges
 Hinged flaps
 Bucket-elevator
 Air-conditioning systems
 General drives for manufacturing and processing machines



- Extreme switching duty
- Squirrel-cage motor
- Operating characteristics
- Inching, plugging, reversing
- Electrical characteristics
- Make: up to 6 x rated motor current
- Break: up to 6 x rated motor current
- Utilization category
- 100 % AC-4
- Typical applications
- Printing presses
- Wire-drawing machines
- Centrifuges
- Special drives for manufacturing and processing machines



Switching conditions for 3 pole, non-motor loads
 Operating characteristics
 Non inductive and slightly inductive loads
 Electrical characteristics
 Switch on: 1 x rated operational current
 Switch off: 1 x rated operational current
 Utilization category
 100 % AC-1
 Typical examples of application
 Electric heat

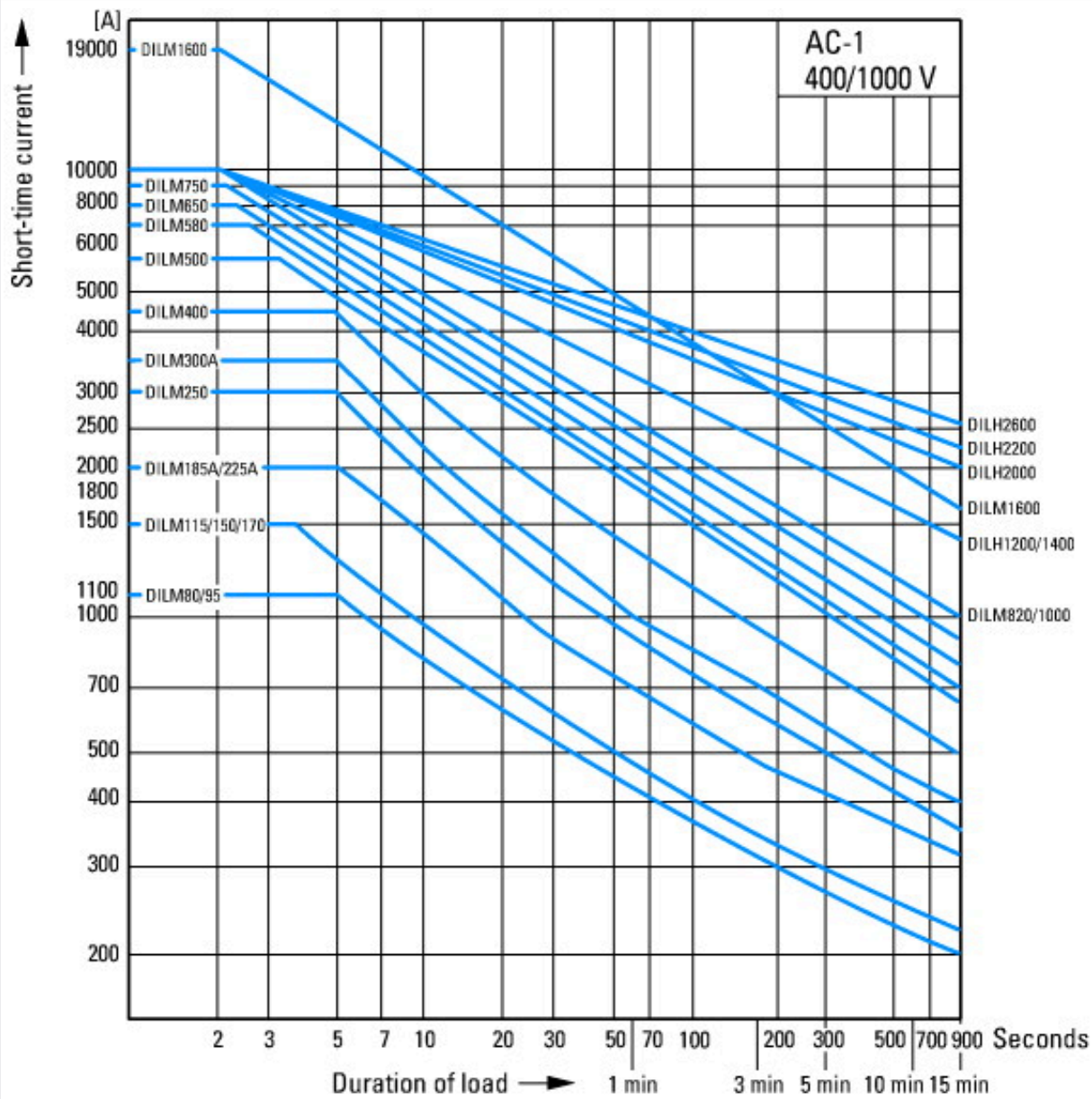

Short-time loading, 3-pole
Time interval between two loading cycles: 15 minutes

Dimensions

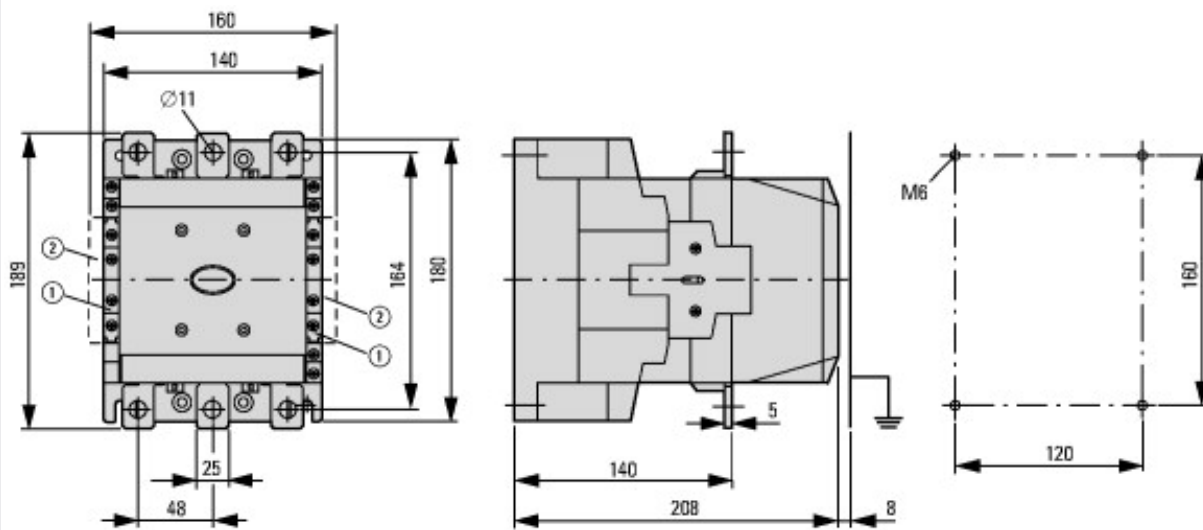

- ① DILM820-XHI11(V)-SI
- ② DILM820-XHI11-SA

Additional product information (links)

IL0340600Z (AWA2100-1639) Contactors >170 A

IL03406002Z (AWA2100-1639) Contactors >170 A	https://es-assets.eaton.com/DOCUMENTATION/AWA_INSTRUCTIONS/IL03406002Z2020_04.pdf
IL03406005Z (AWA2100-2212) Contactors >170 A	
IL03406005Z (AWA2100-2212) Contactors >170 A	https://es-assets.eaton.com/DOCUMENTATION/AWA_INSTRUCTIONS/IL03406005Z2020_04.pdf
Motor starters and "Special Purpose Ratings" for the North American market	http://www.eaton.eu/ecm/groups/public/@pub/@europe/@electrical/documents/content/pct_3258146.pdf
Switchgear of Power Factor Correction Systems	http://www.moeller.net/binary/ver_techpapers/ver934en.pdf
X-Start - Modern Switching Installations Efficiently Fitted and Wired Securely	http://www.moeller.net/binary/ver_techpapers/ver938en.pdf
Mirror Contacts for Highly-Reliable Information Relating to Safety-Related Control Functions	http://www.moeller.net/binary/ver_techpapers/ver944en.pdf
Effect of the Cable Capacitance of Long Control Cables on the Actuation of Contactors	http://www.moeller.net/binary/ver_techpapers/ver949en.pdf
Switchgear for Luminaires	http://www.moeller.net/binary/ver_techpapers/ver955en.pdf
Standard Compliant and Functionally Safe Engineering Design with Mechanical Auxiliary Contacts	http://www.moeller.net/binary/ver_techpapers/ver956en.pdf
The Interaction of Contactors with PLCs	http://www.moeller.net/binary/ver_techpapers/ver957en.pdf
Busbar Component Adapters for modern Industrial control panels	http://www.moeller.net/binary/ver_techpapers/ver960en.pdf