

**Motor protection circuit breakers PKZMC**



- Switches motors up to 32A
- Short-circuit protection capacity up to 65kA
- Common accessories with PKZM0 and PKZM4

**Contents**

**Description**

**Page**

Motor protection circuit breakers PKZMC	
System overview . . . . .	<b>48</b>
Basic devices . . . . .	<b>49</b>
Standard auxiliary contacts . . . . .	<b>50</b>
Trip-indicating auxiliary contact . . . . .	<b>52</b>
Early-make auxiliary contact . . . . .	<b>52</b>
Current limiters . . . . .	<b>52</b>
Shunt release . . . . .	<b>52</b>
Undervoltage release . . . . .	<b>52</b>
Insulated enclosure . . . . .	<b>54</b>
Other accessories . . . . .	<b>56</b>
Actuating voltage . . . . .	<b>59</b>
Tripping characteristic curves . . . . .	<b>60</b>
Technical data . . . . .	<b>61</b>
Dimensions . . . . .	<b>66</b>

### 1 High price-performance-ratio motor protection solutions via PKZMC

#### With PKZMC, everyone can access to modern technology for motor protection

Can be combined with contactors to serve as manually operated motor starter.

Compact and modular design, easy operating, high protection rate.

Common accessories with PKZM0 motor starters.

Comply to all of major standards.

#### Safety first

PKZMC series comply with all technical standards for main switches.

PKZMC can protect your machine equipment powered by small rating motor, and can manually switch on your equipment.

Emergency stop and locking functions come with PKZMC as standard.

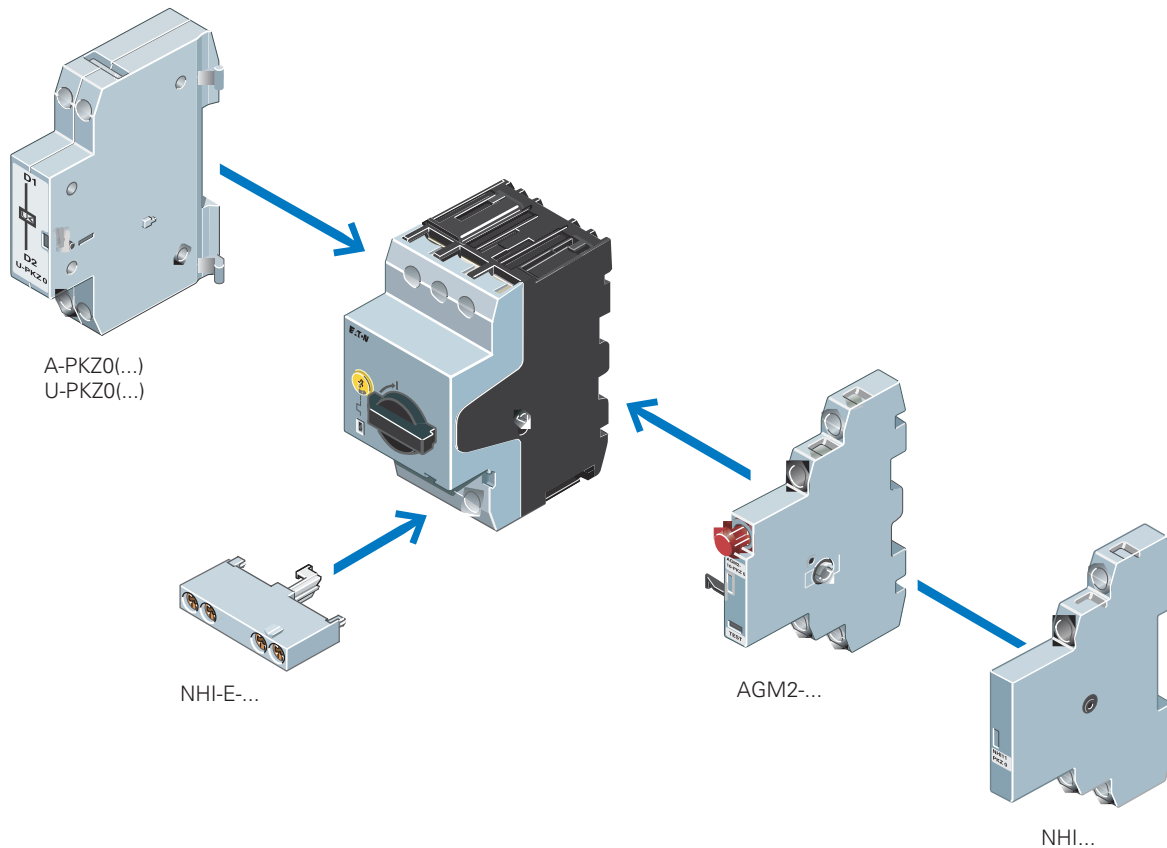

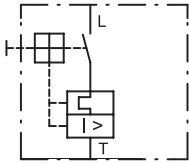
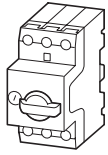

### Basic devices

Max. motor rating AC-3 380/400V P kW	Rated uninterrupted current $I_u$ A	Overload release Setting range $I_r$ A	Rated ultimate short-circuit breaking capacity $I_{cu}$			Part no. Article no.
			220V kA	380/400V kA	440V kA	
–	0.16	0.1 – 0.16	65	65	65	<b>PKZMC-0,16</b> 225358
0.06	0.25	0.16 – 0.25	65	65	65	<b>PKZMC-0,25</b> 225364
0.09	0.4	0.25 – 0.4	65	65	65	<b>PKZMC-0,4</b> 225370
0.12	0.63	0.4 – 0.63	65	65	65	<b>PKZMC-0,63</b> 225376
0.25	1	0.63 – 1	65	65	65	<b>PKZMC-1</b> 225383
0.55	1.6	1 – 1.6	65	65	65	<b>PKZMC-1,6</b> 225387
0.75	2.5	1.6 – 2.5	65	65	65	<b>PKZMC-2,5</b> 225389
1.5	4	2.5 – 4	65	65	65	<b>PKZMC-4</b> 225390
2.2	6.3	4 – 6.3	65	16	6	<b>PKZMC-6,3</b> 225391
4	10	6.3 – 10	16	16	6	<b>PKZMC-10</b> 225394
7.5	16	10 – 16	16	16	6	<b>PKZMC-16</b> 225395
9	20	16 – 20	12	12	6	<b>PKZMC-20</b> 225396
12.5	25	20 – 25	12	12	6	<b>PKZMC-25</b> 225397
15	32	25 – 32	12	12	6	<b>PKZMC-32</b> 112112

# 1.2

## Motor protection circuit breakers PKZMC

### Standard auxiliary contacts

1

#### Standard auxiliary contacts

Contact      Circuit diagrams      Contact sequence      For use with

N/O = normally open contact  
N/C = normally closed contact

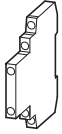

1 N/O    1 N/C

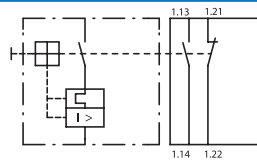
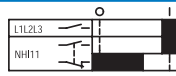

Screw terminals

PKZMC

1 N/O    2 N/C

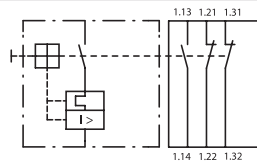
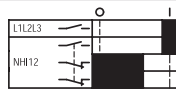

Screw terminals

PKZMC

2 N/O    1 N/C

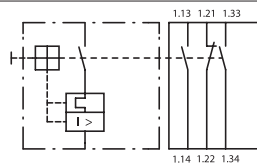
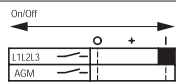

Screw terminals

PKZMC



1 N/O    1 N/C

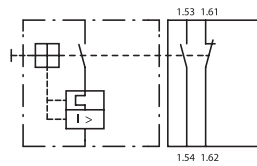

Screw terminals

PKZMC

1 N/O    -

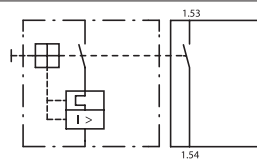
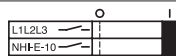

Screw terminals

PKZMC



#### Auxiliary contacts, undervoltage releases

Contact      Circuit diagrams      Contact sequence      For use with

N/O = normally open contact  
N/C = normally closed contact

#### Trip-indicating auxiliary contact

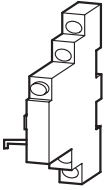

2 × 1 N/O

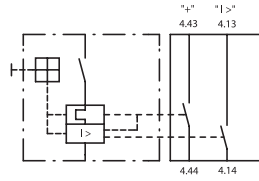
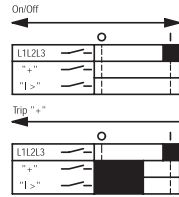

PKZMC

2 × 1 N/C

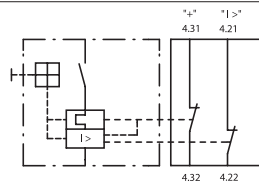
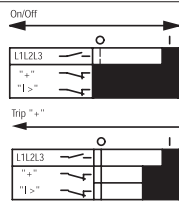

PKZMC

#### Early-make auxiliary contact



2 N/O

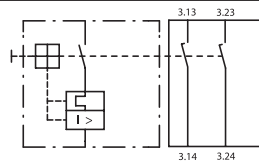

PKZMC

#### Shunt release

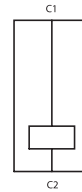
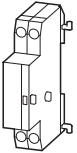

PKZMC

#### Undervoltage release

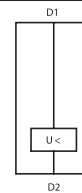
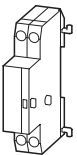

PKZMC

#### Current limiters

For increasing switching capacity of motor-protective circuit-breakers without auto-protection motor-protective circuit breakers PKZM0-16,-20,-25,-32 reach 150kA/440V

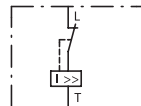

PKZMC

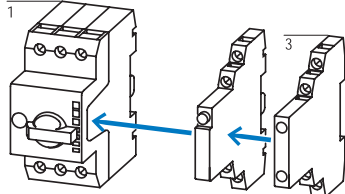
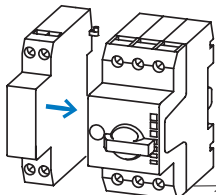
Part no. Article no.	Std. pack	Notes	
<b>AGM2-10-PKZ0</b> 072898	2 off	<p>Can be fitted to the right side of motor-protective circuit-breakers:</p> <p>Can be combined with: Standard auxiliary contacts NHI11-PKZ0 NHI12-PKZ0 NHI21-PKZ0 NHI-E...</p>	
<b>AGM2-01-PKZ0</b> 072899	2 off	<p>Separate indication of: a) General trip indication (overload) b) Short-circuit trip</p> <p>Local short-circuit indication by red indicator, manually resettable.</p>	
<b>VHI20-PKZ0</b> 203595	2 off	<p>Can be fitted to front of motor-protective circuitbreaker, 45 mm width of the motor-protective circuit-breaker remains unchanged. For early energization of undervoltage release, e.g. in emergency switching off circuits to EN 60204.</p>	
<b>A-PKZ0(230V50Hz)</b> 073187	2 off	<p>Can be fitted to the left side of motor-protective circuit-breakers.</p>	
<b>A-PKZ0(24V DC)</b> 073200	2 off	<p>Cannot be combined with: undervoltage release U-PKZ0 DC: Intermittent operation 5 s</p>	
<b>U-PKZ0(230V50Hz)</b> 073135	2 off	<p>Can be fitted to the left side of motor-protective circuit-breakers.</p> <p>Cannot be combined with: A-PKZ0 shunt release When combined with circuit-breaker, can be used as emergency switching off device to IEC/EN 60204.</p>	
<b>CL-PKZ0</b> 082881	1 off	<p>Max. rated operating voltage <math>U_e = 690</math> V, rated uninterrupted current <math>I_u = 63</math> A Can be used for individual and group protection. For group protection and in combination with PKZM4, order additional BK25/3 incoming terminal if required. Mounting next to or behind the motor-protective circuit-breaker. PKZM4: 16 – 63 A: 100 kA/400 V PKZM4: 16 – 63 A: 10 kA/690 V</p>	

Accessories	Page
1 Motor-protective circuit-breakers	→ 49
3 Standard auxiliary contacts	→ 50

Accessories	Page
1 Motor-protective circuit-breakers	→ 49
Further actuating voltages	→ 59

#### 1 Insulated enclosure

##### Enclosure

##### Accessories

Part no.

Degree of protection

Handle color

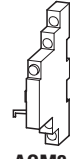
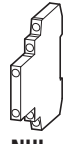

VHI..-PKZO

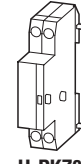

U-PKZO or A-PKZO

L-PKZO

#### Surface mounting enclosure

##### For motor protective circuit breaker PKZMC

		CI-K2-PKZO	IP41	–	•	–	•	–	•	•	
		CI-K2-PKZO	IP41	–	–	–	•	•	–	•	•
		CI-K2-PKZO-G	1P65	Black	•	–	•	–	•	•	•
		CI-K2-PKZO-G	1P65	Black	–	–	•	•	–	•	•
		CI-K2-PKZO-GR	1P65	Red-yellow	•	–	•	–	•	•	•
		CI-PKZO-M	IP40	–	•	–	•	–	–	•	
		CI-PKZO-M	IP40	–	–	–	•	–	•	•	
		CI-PKZO-GM	IP55	Black	•	–	•	–	–	•	
		CI-PKZO-GM	IP55	Black	–	–	•	–	•	•	
		CI-PKZO-GRM	IP55	Red-yellow	•	–	•	–	–	•	•

#### Surface mounting housings

##### For motor protective circuit breaker PKZMC + early-make auxiliary contact VHI-PKZO

		CI-K2-PKZO-GV	IP65	Black	•	–	–	•	•	•
		CI-K2-PKZO-GV	IP65	Black	–	–	•	–	•	•
		CI-K2-PKZO-GRV	IP65	Red-yellow	•	–	–	•	–	•
		CI-K2-PKZO-GVM	IP55	Black	•	–	–	•	–	•
		CI-K2-PKZO-GVM	IP55	Black	–	–	–	•	–	•
		CI-K2-PKZO-GRVM	IP55	Red-yellow	•	–	–	•	–	•

#### Flush mounting enclosure

##### For motor protective circuit breaker PKZMC

		E-PKZO	IP40	–	•	–	–	–	–	•
		E-PKZO	IP40	–	–	–	–	–	•	•
		E-PKZO-G	IP55	Black	•	–	•	–	–	•
		E-PKZO-G	IP55	Black	–	–	–	•	–	•
		E-PKZO1-GR	IP55	Red-yellow	•	–	•	–	–	•











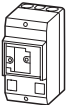
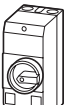

#### Notes

The combination possibilities of circuit-breakers in an enclosure with accessory modules are identified by a •  
1) Always required

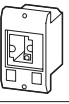

### Insulated enclosure

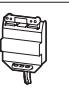
1

		Degree of protection	For use with	Part no. Article no.	Std. pack	
<b>Surface mounting enclosure</b>						
<b>For motor protective circuit breaker PKZMC</b>						
	Cover with aperture dimensioned to accommodate front of breaker. IP40, when mounted turned through 90° to left/right	IP41 with vertical mounting	PKZMC-...+NHI or AGM+U or A (undervoltage or shunt release) +NHI-EL-PKZ0 (2 off)	<b>CI-K2-PKZ0</b> 219653	1 off	M25 metric cable entry knockout, top and bottom Cable push-through membrane top, bottom, in the back plate and as a control line entry.
	With black-grey rotary knob	IP65		<b>CI-K2-PKZ0-G</b> 219654	1 off	Insulated enclosure CI-K2 incl. N and PE terminal.
	With red-yellow rotary knob, for use as emergency switching off device to EN 60204	IP65		<b>CI-K2-PKZ0-GR</b> 219655	1 off	
	Cover with aperture dimensioned to accommodate front of breaker	IP40	PKZMC-... +NHI or U or A +L-PKZ0 (2 off)	<b>CI-PKZ0-M</b> 267083	1 off	Integrated terminal for PE(N) connection, two M25 cable entry knockouts at top and at bottom.
	With black-grey rotary knob	IP55	PKZMC-... +NHI-E	<b>CI-PKZ0-GM</b> 260089	1 off	
	With red-yellow rotary knob, for use as emergency switching off device to IEC/EN 60204	IP55	+NHI or U or A +L-PKZ0 (2 off)	<b>CI-PKZ0-GRM</b> 260104	1 off	
<b>Surface mounting enclosure</b>						
<b>For motor protective circuit breakers PKZMC with early-make VHI-PKZ0 auxiliary contacts</b>						
	With black-grey rotary knob	IP65	+NHI or AGM +U or A	<b>CI-K2-PKZ0-GV</b> 219657	1 off	M25 metric cable entry knockout, top and bottom Cable push-through membrane top, bottom, in the back plate and as a control line entry.
	With red-yellow rotary knob, for use as emergency switching off device to IEC/EN 60204	IP65	+L-PKZ0 (2 off)	<b>CI-K2-PKZ0-GRV</b> 219656	1 off	
	With black-grey rotary knob	IP55	PKZMC-...and VHI +U or A (undervoltage and shunt release)	<b>CI-PKZ0-GVM</b> 263526	1 off	Two M25 cable entry knockouts at top and at bottom.
	With red-yellow rotary knob, for use as emergency switching off device to IEC/EN 60204	IP55	+L-PKZ0 (2 off)	<b>CI-PKZ0-GRVM</b> 263525	1 off	
<b>Flush mounting enclosure</b>						
<b>For motor protective circuit breaker PKZMC</b>						
	Cover with aperture dimensioned to accommodate front of breaker	Front IP40	PKZMC-...+NHI or +U or A+L-PKZ0 (2 off)	<b>E-PKZ0</b> 072906	1 off	Integrated terminal for PE(N) connection, two PG16 cable entry knockouts at top and at bottom.
	With black-grey rotary knob	Front IP55	PKZMC-... +NHI or U or A	<b>E-PKZ0-G</b> 072907	1 off	
	With red-yellow rotary knob, for use as emergency switching off device to IEC/EN 60204	Front IP55	+NHI-E +L-PKZ0 (2 off)	<b>E-PKZ0-GR</b> 072908	1 off	
	For up to 3 padlocks with 3 – 6 mm hasp thickness, for use as main switch to IEC/EN60204		E-PKZ0-G(R)	<b>SVB-PKZ0-E</b> 035127	3 off	Lockable in Off position of PKZMC
<b>Neutral terminal</b>						
<b>For connection of a 5th conductor</b>						
			E-PKZ0(-G)(-GR)	<b>N-PKZ0</b> 082160	20 off	–

1



### Metric cable glands to EN 50262

- With lock nut and built-in strain relief
- IP68 up to 5 bar

Cable entry	Drilling dimensions	External cable diameter	<b>Part no.</b> Article no.	Std. pack
	mm	mm		
M20	20.5	613	<b>V-M20</b> 206910	20 off
M25	25.5	917	<b>V-M25</b> 206911	20 off
M32	32.5	1321	<b>V-M32</b> 206912	10 off
M32	32.5	1825	<b>V-M32G</b> 226156	10 off



### Metric diaphragm grommets

- IP66
- With integral push-through diaphragm

Cable entry	Drilling dimensions	External cable diameter	<b>Part no.</b> Article no.	Std. pack
	mm	mm		
M20	20.5	113	<b>KT-M20</b> 207602	100 off
M25	25.5	118	<b>KT-M25</b> 207603	100 off
M32	32.5	124	<b>KT-M32</b> 207604	100 off



### Door coupling handles

- IP65

	Handle color	For use with	<b>Part no.</b> Article no.	Std. pack	
For use as main switch to IEC/EN 60204	Black	PKZMC	<b>PKZ0-XH</b> 106132	1 off	Pluggable PKZ0-XAH extension shaft, can be cut to any required length for installation depths of 100...240 mm. Follower included in delivery. With ON/OFF switch position and "+" (tripped), lockable. With 3 padlocks, 4 – 8 mm hasp.
For use as a main switch with emergency switching off function to IEC/EN 60204	Red/yellow	PKZMC	<b>PKZ0-XRH</b> 106133	1 off	
For use as a main switch to IEC/EN 60204 in MCC power distribution systems and with PKZMC installed rotated by 90°	Black	PKZMC	<b>PKZ0-XH-MCC</b> 106136	1 off	
For use as a main switch with emergency switching off function to IEC/EN 60204 in MCC power distribution systems and with PKZMC installed rotated by 90°	Red/yellow	PKZMC	<b>PKZ0-XRH-MCC</b> 106137	1 off	

### Other accessories

1

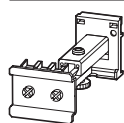

#### Telescopic adapters

With 45 mm top-hat rail to IEC/EN 60715 for compensation of the mounting depth of rear-mounted devices enclosures CI-K and cabinets.

For use with motor-protective circuit-breakers PKZMC	Part no. Article no.	Std. pack	
	<b>M22-TA</b> 226161	1 off	Stepless adjustment via scale from 75 – 115 mm



#### Lockable rotary handle

For locking motor-protective circuit-breakers PKZMC as a main switch in compliance with EN 60204.

Can be padlocked in the "0" position.

Hasp thickness: 3 – 6.35 mm

#### Holding facility

To prevent tampering with the overload release and the test function, it can be sealed using industry standard sealing wire

For use with motor-protective circuit-breakers PKZMC

	<b>AK-PKZO</b> 030851	5 off	–
--	--------------------------	-------	---

	<b>PL-PKZO</b> 203599	5 off	–
--	--------------------------	-------	---



#### Indicator lights with glow lamp

For use with

Color	Voltage	Part no. Article no.	Std. pack
-------	---------	-------------------------	-----------

V

CI-K2-PKZO-... CI-K4-PKZ4	White	110 – 230	<b>L-PKZO(230V)</b> 082151	10 off	–
E-PKZO-... CI-PKZO1 E-PKZO1	White	230 – 400	<b>L-PKZO(400V)</b> 082152	10 off	–
	White	415 – 500	<b>L-PKZO(500V)</b> 082153	5 off	–
CI-K2-PKZO-... CI-K4-PKZ4	Green	110 – 230	<b>L-PKZO-GN(230V)</b> 082154	10 off	–
E-PKZO-... CI-PKZO1 E-PKZO1	Green	230 – 400	<b>L-PKZO-GN(400V)</b> 082155	10 off	–
	Green	415 – 500	<b>L-PKZO-GN(500V)</b> 082156	5 off	–
CI-K2-PKZO-... CI-K4-PKZ4	Red	110 – 230	<b>L-PKZO-RT(230V)</b> 082157	10 off	–
E-PKZO-... CI-PKZO1 E-PKZO1	Red	230 – 400	<b>L-PKZO-RT(400V)</b> 082158	10 off	–
	Red	415 – 500	<b>L-PKZO-RT(500V)</b> 082159	5 off	–

# 1.2

## Motor protection circuit breakers PKZMC

### Other accessories

#### Other accessories

	For use with	Part no. Article no.	Std. pack	Notes
<b>wiring kit</b>	PKZM0+DILM17..C PKZM0+DILM25..C PKZM0+DILM32..C	<b>PKZM0-XM32DE</b> 239349	5 off	<ul style="list-style-type: none"> <li>Main supply wiring between PKZMC and contactor</li> <li>Use only in combination with busbar adapter</li> </ul>

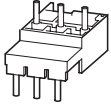

#### Other accessories

	circuit-breakers/ compact starters	length	Unit width	Part no. Article no.	Std. pack	Notes
	Number	mm	mm			

#### Three-phase commoning links, incoming unit via terminals 1, 3, and 5

Finger- and back-of-hand-proof, short-circuit proof,  $U_e = 690V$ ,  $I_u = 63A$   
Can be extended through rotated installation

For PKZMC... without side-mounted auxiliary contacts or voltage releases

	2	90	45	<b>B3.0/2-PKZO</b> 063961	10 off	For parallel feeding of multiple motor-protective circuit-breakers on terminals 1, 3, and 5
	3	135	45	<b>B3.0/3-PKZO</b> 232289	10 off	
	4	180	45	<b>B3.0/4-PKZO</b> 063960	10 off	
	5	225	45	<b>B3.0/5-PKZO</b> 232290	10 off	

For motor-protective circuit-breakers with one auxiliary contact or trip-indicating auxiliary contact each fitted to right side

	2	99	45 + 9	<b>B3.1/2-PKZO</b> 044945	10 off	For parallel feeding of multiple motor-protective circuit-breakers on terminals 1, 3, and 5
	3	153	45 + 9	<b>B3.1/3-PKZO</b> 044946	10 off	
	4	207	45 + 9	<b>B3.1/4-PKZO</b> 044947	10 off	
	5	261	45 + 9	<b>B3.1/5-PKZO</b> 044948	10 off	

For PKZMC... with one auxiliary contact or trip-indicating auxiliary contact each fitted to right side, or one voltage release fitted on left side

	2	108	45 + 18	<b>B3.2/2-PKZO</b> 063963	10 off	For parallel feeding of multiple motor-protective circuit-breakers on terminals 1, 3, and 5
	4	234	45 + 18	<b>B3.2/4-PKZO</b> 063959	10 off	

#### Shroud for unused terminals

Protection against direct contact.

For covering unused terminals on three-phase commoning link B3...-PKZO

	–	–	–	<b>H-B3-PKZO</b> 032721	20 off	–
--	---	---	---	----------------------------	--------	---

#### Incoming terminals

	–	–	–	<b>BK25/3-PKZO</b> 032720	5 off	For three-phase commoning link, protected against accidental contact, $U_e = 690V$ , $I_u = 63A$ For conductor cross-sections: 2.5 – 25 mm <sup>2</sup> stranded 2.5 – 16 mm <sup>2</sup> flexible with ferrule AWG 14 – 6, usable on terminals 1, 3, and 5
--	---	---	---	------------------------------	-------	---

### Shunt release, undervoltage release

AC	A-PKZ0(...)	Std. pack	U-PKZ0(...)	Std. pack
	Article no. <sup>1)</sup>		Article no. <sup>1)</sup>	
<b>Standard voltage</b>				
24V 50Hz	073181	2 Off	073129	2 Off
110V 50Hz	073184	2 Off	073132	2 Off
220V 50Hz	073186	2 Off	073134	2 Off
230V 50Hz	073187	2 Off	073135	2 Off
380V 50Hz	073189	2 Off	073137	2 Off
<b>Non-standard voltages not covered by above standard voltages<sup>2)</sup></b>				
... V 50Hz(24 – 500V)	982165	2 Off	982162	2 Off
... V 60Hz(24 – 600V)	982166	2 Off	982163	2 Off
<b>DC</b>				
<b>Standard voltage</b>				
24V DC	073200	2 Off	–	
110V DC	073203	2 Off	–	

#### Notes

- 1) The part number for ordering consists of the basic part number and the actuating voltage.
- 2) For non-standard voltages, specify the required actuating voltage within the indicated range (... - ... V). Minimum order quantity is 10 units.

# 1.2

## Motor protection circuit breakers PKZMC

### Tripping characteristic curves

#### 1 Motor-protective circuit breaker PKZMC tripping characteristics

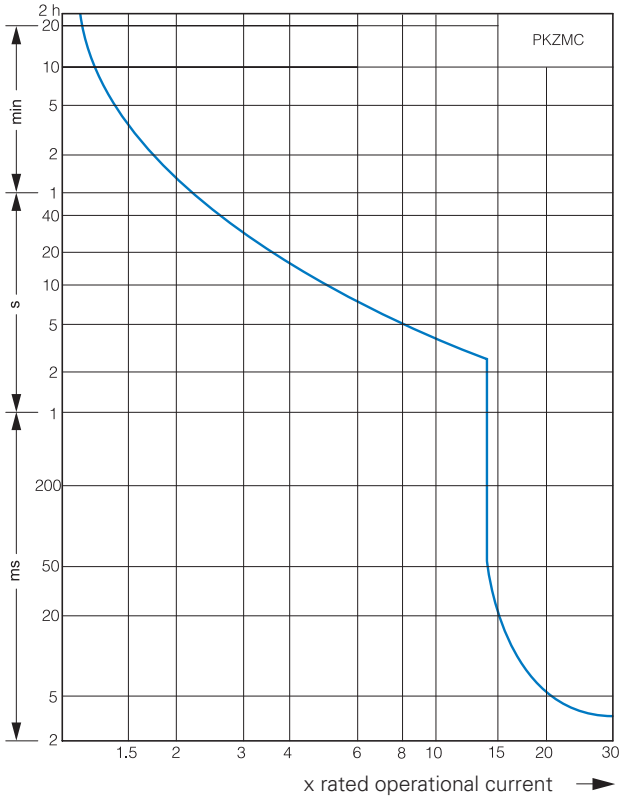

#### Let-through characteristics, motor-protective circuit-breaker

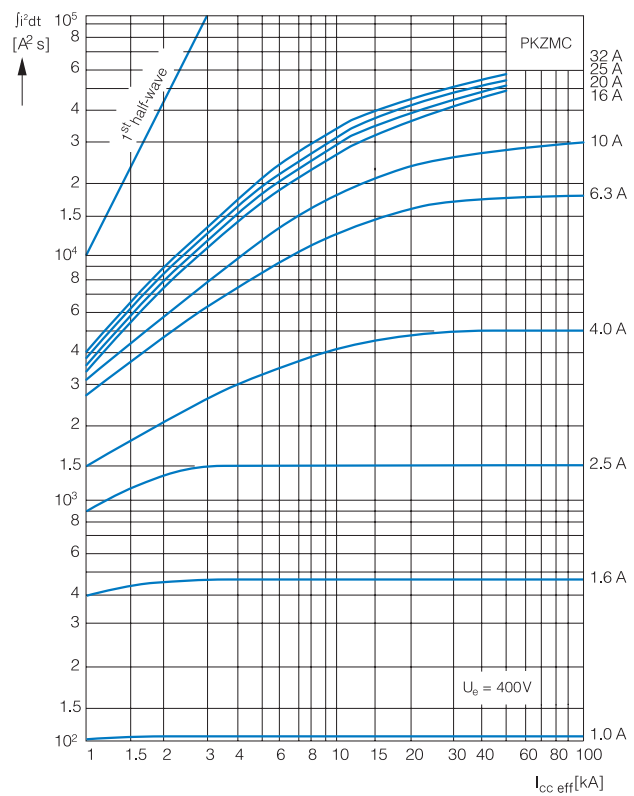
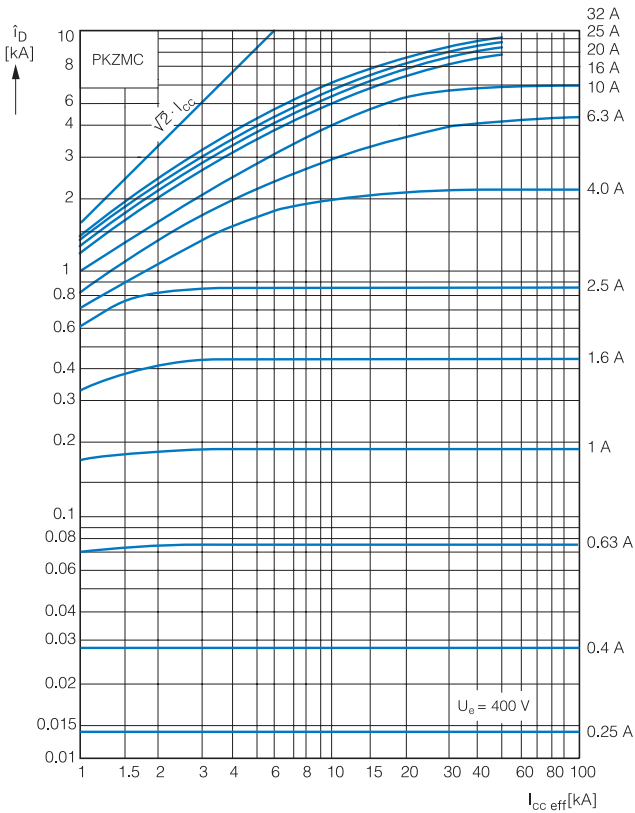

## Circuit-breaker switching capacity from serial no. 04

Rated uninterrupted current  $I_u$

Rated conditional short-circuit current  $I_q$  IEC/EN60947-4-1

Rated ultimate short-circuit breaking capacity  $I_{cu}$  } IEC/EN 60947-2

Rated breaking capacity  $I_{cs}$

$I_u$ A	230V				400V				440V			
	$I_q$ kA	$I_{cu}$ kA	$I_{cs}$ kA	A <sup>1)</sup>	$I_q$ kA	$I_{cu}$ kA	$I_{cs}$ kA	A <sup>1)</sup>	$I_q$ kA	$I_{cu}$ kA	$I_{cs}$ kA	A <sup>1)</sup>
PKZMC, With type "1" and "2" coordination												
0.16 - 1	65	65	65	N	65	65	65	N	65	65	65	N
1.6	65	65	65	N	65	65	65	N	65	65	65	N
2.5	65	65	65	N	65	65	65	N	65	65	65	N
4	65	65	65	N	65	65	65	N	65	65	65	N
6.3	65	65	65	N	16	16	8	50	6	6	3	50
10	16	16	8	50	16	16	8	50	6	6	3	50
12	16	16	8	50	16	16	8	50	6	6	3	50
16	16	16	8	50	16	16	8	50	6	6	3	50
20	12	12	6	50	12	12	6	50	6	6	3	50
25	12	12	6	50	12	12	6	50	6	6	3	50
32	12	12	6	50	12	12	6	50	6	6	3	50
PKZMC + CL-PKZO												
0.16 - 1				N				N				N
1.6				N				N				N
2.5				N				N				N
4				N				N				N
6.3				N				N				N
10				N				N				N
12				N				N				N
16				N				N				N
20				N				N				N
25				N				N				N
32				N				N				N
PKZMC + 2 CL-PKZO												
0.16 - 1				N				N				N
1.6				N				N				N
2.5				N				N				N
4				N				N				N
6.3				N				N				N
10				N				N				N
12				N				N				N
16				N				N				N
20				N				N				N
25				N				N				N
32				N				N				N

### Notes

■ No upstream protective device required, as it is the autoprotected range (100/150 kA)

1) Required back-up fuse if the short-circuit current exceeds the device's rated conditional short-circuit current ( $I_{cc} > I_q$ ).

N Not necessary

## 1 Technical data

## PKZMC-...

**General**

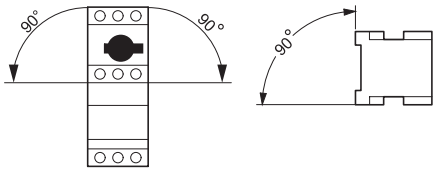
Standards	IEC/EN 60947, GB14048		
Climatic proofing	Damp heat, constant, to IEC 60068-2-78 Damp heat, cyclic, to IEC 60068-2-30		
Ambient temperature	Storage	°C	-25...80
	Open	°C	-25...55
	Encapsulated	°C	-25...40
Built-in position			
Direction of incoming supply	Any		
Degree of protection	Device	IP20	
	Terminals	IP00	
Contact protection to EN 50274	Finger- and back-of-hand proof		
Shock resistance, half-sinusoidal shock, 10 ms to IEC 60068-2-27	g	25	
Installation altitude	m	2000	
Terminal capacity	Solid	mm <sup>2</sup>	1 × (1 – 6) 2 × (1 – 6)
		Flexible with ferrule to DIN 46228	mm <sup>2</sup>
	Solid or stranded	AWG	18 – 10
Terminal screw tightening torque			
Main conductors	Nm	1.7	
Auxiliary conductors	Nm	1	
<b>Main contacts</b>			
Rated impulse withstand voltage	$U_{imp}$	V AC	6000
Overvoltage category/pollution degree	III/3		
Rated operational voltage	$U_e$	V AC	440
Rated uninterrupted current = rated operational current	$I_u = I_e$	A	32 or current setting of the overcurrent release
Rated frequency	Hz		40 – 60
Heat dissipation (3 pole at operating temperature)	W		6
Lifespan, mechanical	Operations	× 10 <sup>6</sup>	0.05
Lifespan, electrical (AC-3 at 400 V)	Operations	× 10 <sup>6</sup>	0.05
Maximum operating frequency	Operations/h	Ops/h	40
Short-circuit rating			
AC	→ Page 61		
DC	kA	60 (Up to PKZMC-16) 40 (PKZMC-20 to PKZMC-32)	
Motor switching capacity	AC-3 (up to 690 V)	A	32
	DC-5 (up to 250 V)	A	25 (3 contacts in series)
<b>Trip blocks</b>			
Temperature compensation			
To IEC/EN 60947, VDE 0660	°C	-5...40	
Operating range	°C	-25...55	
Temperature compensation residual error for T > 40°C	%/K	≤ 0.25	
Setting range of overload releases	× $I_u$	0.6 – 1	
Fixed value of short-circuit releases	× $I_u$	14	
Short-circuit releases tolerance	%	± 20	
Phase-failure sensitivity	IEC/EN 60947-4-1, VDE 0660 Part102		



### Technical data

1

			NHI...PKZO	NHI-E...PKZO	VHI...PKZO	AGM
<b>Auxiliary contacts</b>						
Rated impulse withstand voltage	$U_{imp}$	V AC	6000	4000	4000	6000
Overvoltage category/pollution degree			III/3	III/3	III/3	III/3
Rated operational voltage	$U_e$	V AC	500	440	440	500
	$U_e$	V DC	250	250	250	250
Safe isolation according to EN 61140						
Between auxiliary contacts and main contacts		V AC	690	690	690	690
Rated operational current						
AC-15						
220-240V	$I_e$	A	3.5	1	1	3.5
380-415V	$I_e$	A	2	–	–	2
440-500V	$I_e$	A	1	–	–	1
DC-13 L/R $\leq 100$ ms						
24 V	$I_e$	A	2	2	2	2
60 V	$I_e$	A	1.5	–	–	1.5
110 V	$I_e$	A	1	–	–	1
220 V	$I_e$	A	0.25	–	–	0.25
Durability						
Lifespan, mechanical	Operations	$\times 10^6$	0.1	0.1	0.1	0.01
Lifespan, electrical	Operations	$\times 10^6$	0.05	0.1	0.1	0.05
Control circuit reliability (at $U_e = 24$ V DC, $U_{min} = 17$ V, $I_{min} = 5.4$ mA)	Fault probability	$\lambda$	< one failure in 100 million operations			
Interlocked opposing contacts			Yes	–	–	–
Short-circuit rating without welding						
Fuseless			FAZ-B4/1-HI	–	–	FAZ-B4/1-HI
Fuse		A gG/gL	10	10	10	10
<b>Terminal capacity</b>						
Solid or flexible conductor with ferrule		mm <sup>2</sup>	0.75 – 2.5	0.75 – 1.5	0.75 – 1.5	0.75 – 2.5
Solid or stranded		AWG	18 – 14	18 – 16	18 – 16	18 – 14

## 1 Technical data

## U-PKZ...

**undervoltage releases**

conductor cross-sections	Solid or flexible conductor with ferrule	mm <sup>2</sup>	1 × (0.75 – 2.5) 2 × (0.75 – 2.5)
	Solid or stranded	AWG	1 × (18 – 14) 2 × (18 – 14)

**Main contacts**

Rated operational voltage		U <sub>e</sub>	V AC	42 – 480
Rated operational voltage		U <sub>e</sub>	V DC	24 – 250
Pick-up voltage			× U <sub>s</sub>	0.85 – 1.1
Drop-out voltage			× U <sub>s</sub>	0.7 – 0.35
Power consumption	AC	Pick-up	VA	5
	AC	Holding	VA	3

## Technical data

## A-PKZ...

**shunt releases**

conductor cross-sections	Solid or flexible conductor with ferrule	mm <sup>2</sup>	1 × (0.75 – 2.5) 2 × (0.75 – 2.5)
	Solid or stranded	AWG	1 × (18 – 14) 2 × (18 – 14)

**Main contacts**

Rated operational voltage		U <sub>e</sub>	V AC	42 – 480
Rated operational voltage		U <sub>e</sub>	V DC	24 – 250
Range of operational voltage	AC		× U <sub>s</sub>	0.7 – 1.1
	DC (intermittent operation 5 s)		× U <sub>s</sub>	0.7 – 1.1
Power consumption	AC	Pick-up	VA	5
		Holding	VA	3
	DC	Pick-up	W	3
		Holding	W	3

## 1- and 2-pole-connected PKZMC with AC and DC



## Protection of PVC-insulated cables against thermal overload on short-circuits

The table specifies which minimum conductor cross-sections are protected by motor-protective circuit-breaker PKZMC up to their rated conditional short-circuit current  $I_q$

Min. cross-section protected 380 – 415 V, 50 Hz, Cu mm <sup>2</sup>					Device Part no.
4	2.5	1.5	1	0.75	
					PKZMC-0.16
					PKZMC-6.3
					PKZMC-10
					PKZMC-16
					PKZMC-20
					PKZMC-25
					PKZMC-32
					PKZMC-16
					PKZMC-25
					PKZMC-32
					PKZMC-40
					PKZMC-50
					PKZMC-58
					PKZMC-63

## Diagram of back-up protection by PKZ(M)

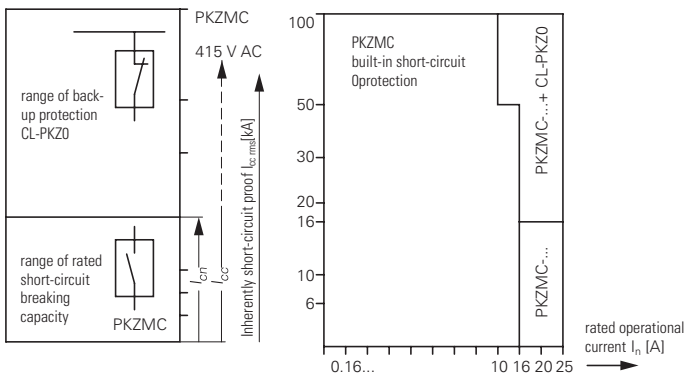

# 1.2

## Motor protection circuit breakers PKZMC

### Dimensions

1

#### Motor-protective circuit-breaker

PKZMC-...(+NHI-E...-PKZ0)

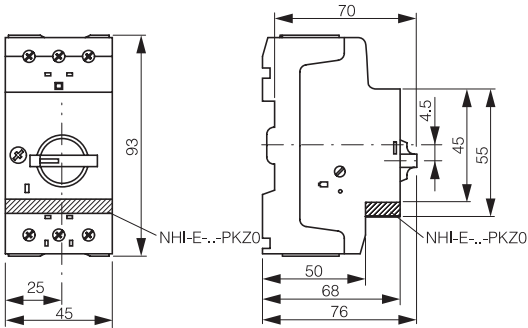

#### Motor-protective circuit-breakers with lockable rotary handles

PKZMC-...+AK-PKZ0

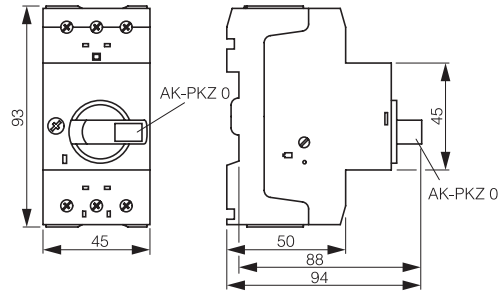

#### Current limiters

CL-PKZ...

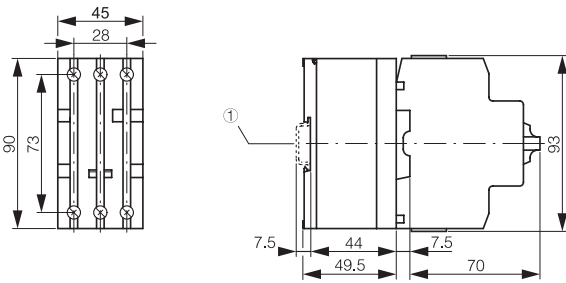

① IEC/EN 60715 Standard rail

#### Motor-protective circuit-breakers with early-make auxiliary contacts

PKZMC-...+VHI...-PKZ0

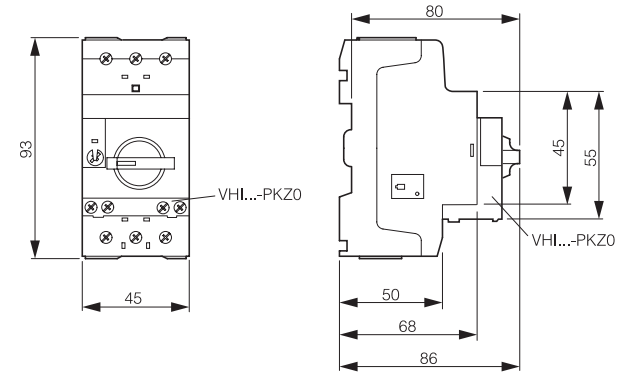

#### Standard auxiliary contacts

NHI...-PKZ0

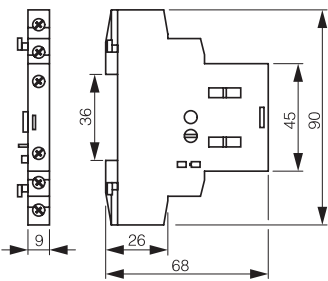

#### Trip indicators

AGM2...-PKZ0

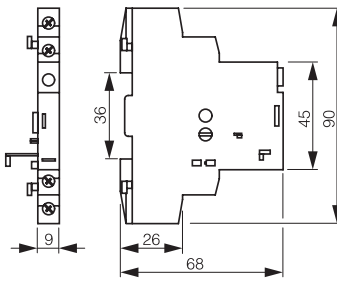

#### Undervoltage release

U/A-PKZ0

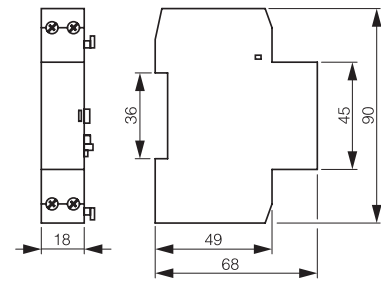

### Insulated enclosures for surface mounting

CI-PKZ0

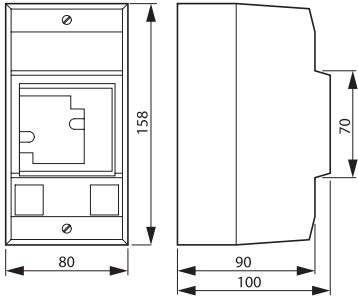

CI-PKZ0-G(R)(V)

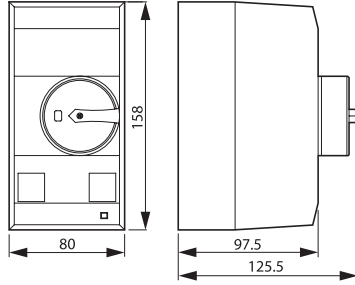

CI-PKZ0-G(R)(V)  
+SVB-PKZ0-CI

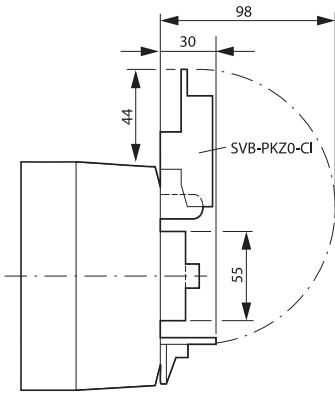

Drilling dimensions  
CI-PKZ0...

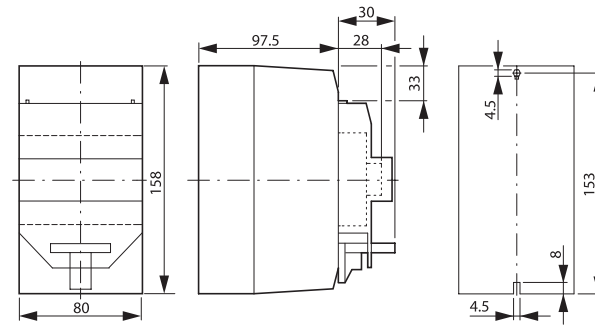

CI-K2-PKZ0

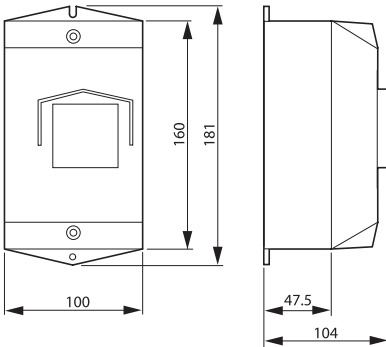

CI-K2-PKZ0G(R)(V)

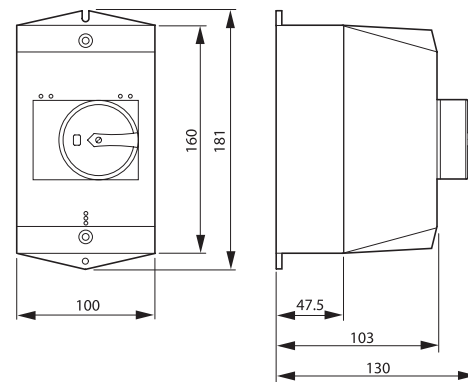

CI-K2-PKZ0-G(R)(V)  
+SVB-PKZ0-CI

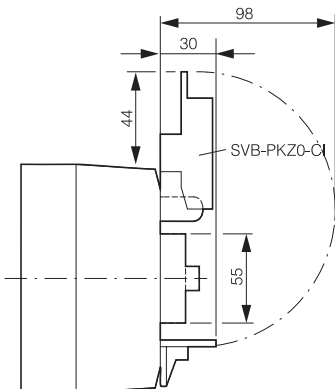

Drilling dimensions  
CI-K2-PKZ0...

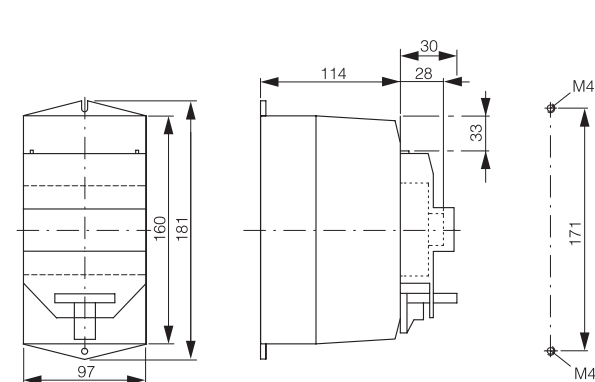

# 1.2

## Motor protection circuit breakers PKZMC

### Dimensions

#### 1 Insulated enclosures for flush mounting

E-PKZ0  
E-PKZ0-G(R)

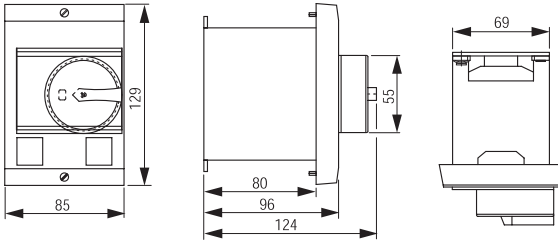

Mounting aperture  
E-PKZ0...

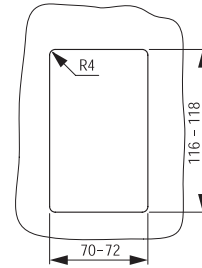

E-PKZ0-G(R)+SVB-PKZ0-E

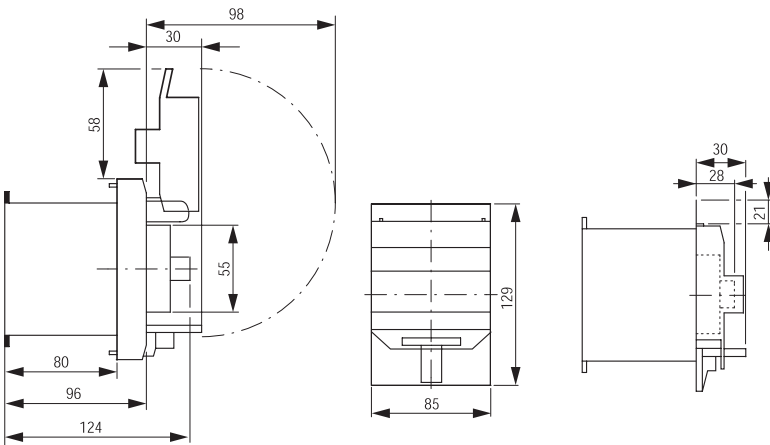

#### Door coupling handles

PKZ0-XH

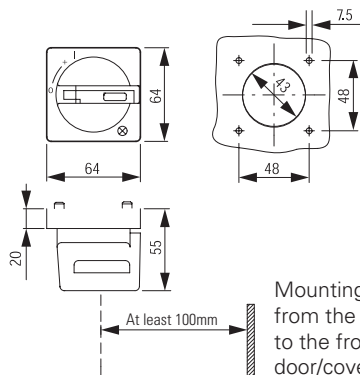

Mounting depth: 100 to 240 mm  
from the top edge of the top-hat rail  
to the front edge of the cabinet  
door/cover