

Contactors

1

E Line contactors



xStart series contactors



xStart C series contactors



D Line contactors



1.1 E Line contactors

1.2 xStart series contactors

1.3 xStart C series contactors

1.4 D Line contactors

EATON

Powering Business Worldwide

Control relays XTRG



Control relays XTRG

Product description

Part of the E Line family of controls, the XTRG control relay offers space savings, enhanced reliability and more efficient use of materials. Rated to operate thermal currents up to 10A, AC voltages up to 660V or DC voltages up to 250V, the XTRG contactor relay offers optimum performance in a compact package.

Features

- 10A Control relay
- 690V Insulation rating
- 660VAC or 250VDC Operational voltage
- Up to 5 sets of normally open or normally closed contacts with add-on blocks
- All common AC control voltages
- DIN rail or panel mount options
- Unique 27mm design

Contents

Description

Description	Page
Control relays XTRG	
System overview	1
Basic devices XTRG	2
Auxiliary contact modules	3
Technical data	4

System overview

Control relays are used to remotely switch small loads or in complex control schemes. The XTRG relay can be integrated with contactors from the E Line family of motor controls to create compact, efficient control panels for a multitude of applications.

Standards and certifications

- GB 14048
- IEC/EN 60947
- CCC
- CE

Accessory overview

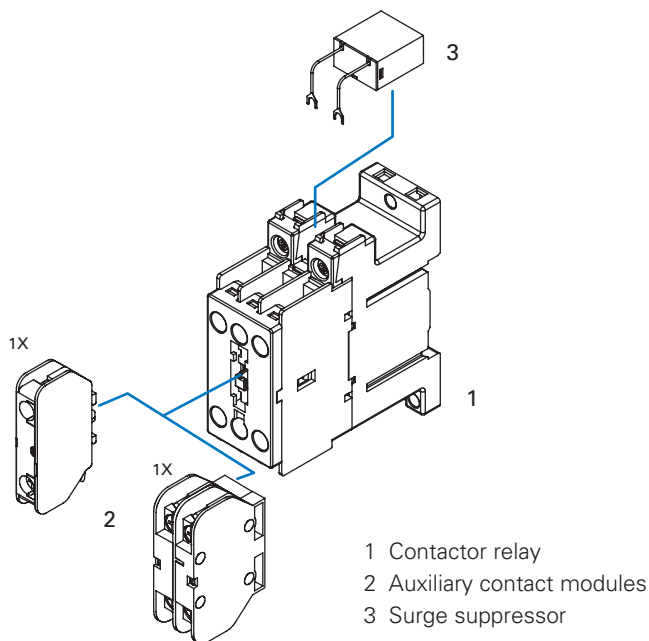

1.1

Control relays XTRG

Basic devices / Auxiliary contact modules, actuating voltages

1

XTRG

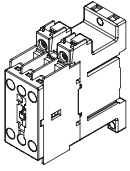

Control relays

Connection type	Contact		Rated operational current		Conventional thermal current, open, 40°C I _{th} (A)	Circuit symbol	Can be combined with auxiliary contact module	AC operation	Standard package
	N/O=Normally open N/C=Normally closed		AC-15	I _e (A)				Part no. Article no.	
Screw terminals	3 N/O	-	220V 230V 240V	380 V 400 V 415 V	10		XTCGXFAC10 XTCGXFAC..	XTRG10B30DT 168044	1 piece
Screw terminals	2 N/O	1 N/C	4	1.9	10		XTCGXFAC10 XTCGXFAC..	XTRG10B21DT 167927	1 piece
Screw terminals	1 N/O	2 N/C	4	1.9	10		XTCGXFAC10 XTCGXFAC..	XTRG10B12DT 167968	1 piece
Screw terminals	-	3 N/C	4	1.9	10		XTCGXFAC10 XTCGXFAC..	XTRG10B03DT 167978	1 piece

Actuating voltages

Coil Voltage	3NO	2NO/1NC	1NO/2NC	3NC
24VAC 50Hz	XTRG10B30B5 168040	XTRG10B21B5 167923	XTRG10B12B5 167933	XTRG10B03B5 167974
36VAC 50Hz	XTRG10B30DS 168041	XTRG10B21DS 167924	XTRG10B12DS 167934	XTRG10B03DS 167975
48VAC 50Hz	XTRG10B30C5 168042	XTRG10B21C5 167925	XTRG10B12C5 167966	XTRG10B03C5 167976
110VAC 50Hz	XTRG10B30E5 168043	XTRG10B21E5 167926	XTRG10B12E5 167967	XTRG10B03E5 167977
220VAC 50Hz	XTRG10B30DT 168044	XTRG10B21DT 167927	XTRG10B12DT 167968	XTRG10B03DT 167978
380VAC 50Hz	XTRG10B30DU 168047	XTRG10B21DU 167930	XTRG10B12DU 167971	XTRG10B03DU 167936
24V 50/60Hz	XTRG10B30B2 177675	XTRG10B21B2 177687	XTRG10B12B2 177693	XTRG10B03B2 177681
36V 50/60Hz	XTRG10B30DV 177676	XTRG10B21DV 177688	XTRG10B12DV 177694	XTRG10B03DV 177682
48V 50/60Hz	XTRG10B30C2 177677	XTRG10B21C2 177689	XTRG10B12C2 177695	XTRG10B03C2 177683
110V 50/60Hz	XTRG10B30E2 177678	XTRG10B21E2 177690	XTRG10B12E2 177696	XTRG10B03E2 177684
220V 50/60Hz	XTRG10B30A0 177679	XTRG10B21A0 177691	XTRG10B12A0 177697	XTRG10B03A0 177685
380V 50/60Hz	XTRG10B30AR 177680	XTRG10B21AR 177692	XTRG10B12AR 177698	XTRG10B03AR 177686
24V DC	XTRG10B30B0 178153	XTRG10B21B0 178152	XTRG10B12B0 178154	XTRG10B03B0 178151

Auxiliary contact, top mounting

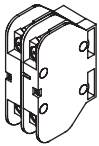

Auxiliary contact modules

Connection type		Conventional thermal current open, 40°C	Contact		Circuit symbol	Can be combined with control relay	Part no. Article no.	Standard package
Screw terminals	1 pole	10	1 N/O	-		XTRG10B..	XTCGXFAC10 167939	1 piece
	1 pole	10	-	1 N/C		XTRG10B..	XTCGXFAC01 167940	1 piece
	2 pole	10	2 N/O	-		XTRG10B..	XTCGXFAC20 167941	1 piece
	2 pole	10	1 N/O	1 N/C		XTRG10B..	XTCGXFAC11 167942	1 piece
	2 pole	10	-	2 N/C		XTRG10B..	XTCGXFAC02 167943	1 piece

$$I_{th} = I_e \text{ AC-1 A}$$

Coil surge suppressor

Coil voltage	RC	Varistor
24-48V	XTCGXRSCN2 167946	XTCGXVSCN2 167949
110-220V	XTCGXRSCDV 167947	XTCGXVSCDV 167950
380-440V	XTCGXRSCCM 167948	XTCGXVSCCM 167951

General

			XTRG10B..	XTCGXFAC..
Standards			IEC/EN 60947, GB 14048	
Mechanical lifespan				
AC operated	Operations	x 10 ⁶	10	10
Maximum operating frequency				
Maximum operating frequency	Operations/h		3600	3600
Climatic proofing			Damp heat, constant, to IEC 60068-2-78 Damp heat, cyclic, to IEC 60068-2-30	
Ambient temperature				
Operation		°C	-25-55	-25-55
Storage		°C	-40-80	-40-80
Protection type			IP20	IP20
Weight approximate weight		kg	0.17	0.02

Contacts





			XTRG10B..	XTCGXFAC..
Rated impulse withstand voltage	U _{imp}	VAC	6000	6000
Overvoltage category/degree of pollution			III/3	III/3
Rated insulation voltage	U _i	VAC	690	690
Rated operational voltage	U _e	VAC	660	660
Rated operational current				
AC-15				
120V	I _e	A	6	6
240V	I _e	A	4	4
380V	I _e	A	1.9	1.9
480V	I _e	A	1.5	
500V	I _e	A	1.4	
600V	I _e	A	1.2	
DC-13				
125V	I _e	A	0.55	0.55
250V	I _e	A	0.27	0.27
Conventional thermal current			I _{th}	A
			10	10
Electrical lifespan				
at U _e =230V, AC-15, 3A	Operations	x 10 ⁶	1	1

Magnet system

			XTRG10B..
Voltage tolerance	Pick-up	x U _c	0.85-1.1
Power consumption of coil in a cold state and 1.0 xU _c (50Hz)	Pick-up	VA	30
	Sealing	VA	6
	Sealing	W	2
	Sealing	W	2
Power consumption of coil in a cold state and 1.0 xU _c (50/60Hz)	50Hz Pick-up	VA	35
	50Hz Sealing	VA	6.5
	50Hz Sealing	W	2.3
	50Hz Sealing	W	2.3
Power consumption of coil in a cold state and 1.0 xU _c (50/60Hz)	60Hz Pick-up	VA	30
	60Hz Sealing	VA	6
	60Hz Sealing	W	2.1
	60Hz Sealing	W	2.1
Power consumption of coil in a cold state and 1.0 xU _c (24VDC)	Pick-up	VA	12
	Sealing	W	3

Terminals

XTRG10B..

	 mm ²	 mm ²	Nm
	0.75-2.5	0.75-2.5	0.8
	0.75-2.5	0.75-2.5	

XTCGXFAC..

A1 / A2 / Aux	mm ²	Nm
	0.75-2.5	0.8
		

Contactors XTCG



Contactors XTCG

Product description

The XTCG is the flagship of the E Line family of motor controls. The XTCG contactor offers space savings, enhanced reliability and more efficient use of materials. Boasting AC-3 ratings up to 95A @ 400V and with a maximum operating voltage of 660V, XTCG offers tremendous performance in a small package.

Features

- Technologically advanced contact design
- 690V insulation rating
- Operating voltage up to 660VAC
- Up to (3) add on auxiliary contact modules
- All common AC control voltages
- DIN rail or panel mount options
- Unique space saving design

Contents

Description

<i>Description</i>	<i>Page</i>
Contactors XTCG	
System overview	6
Product selection	
Basic devices XTCG	7
Auxiliary contact modules	7
Accessories.	7
Technical data	
Contactors XTCG.	10
Auxiliary contact modules	12

System overview

3 phase contactors are used to start motors or control industrial loads. The E Line family of contactors allows the starting of motors up to 45kW, and when combined with an XTOD overload relay or PKZC motor protective circuit breaker offers a complete package of protection and control for long life and reliable operation.

Standards and certifications

- GB 14048
- IEC/EN 60947
- CCC
- CE

Accessory overview

7-12A Frame

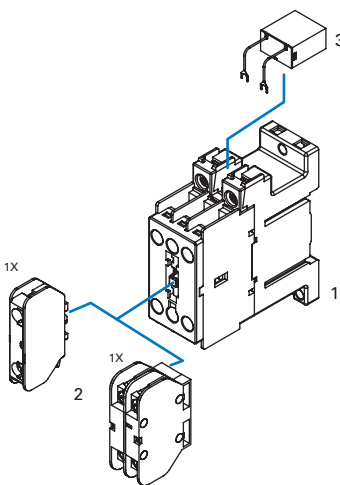

18-38A Frame

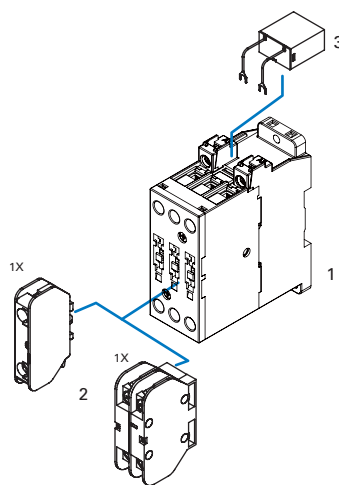

40-95A Frame

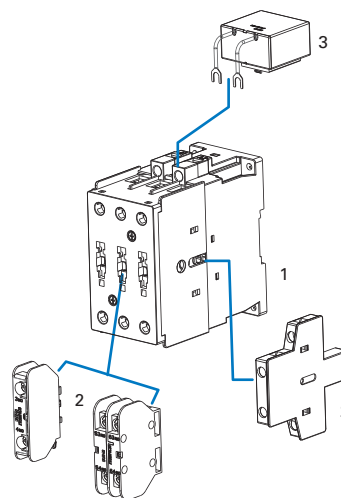

With mechanical interlock

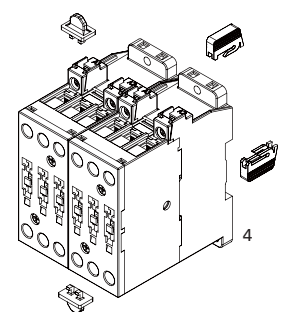

- 1 Contactor relay
- 2 Auxiliary contact modules
- 3 Surge suppressor
- 4 Interlocking kit

XTCG



3-pole contactors

Connection type	Rated operational current AC-3 I _e (A) 380V	Max motor rating for 3-phase motors, 50-60Hz AC-3 P kW			Conventional thermal current, open, 40 °C I _{th} = I _e AC-1(A)	Circuit symbol	AC operation Part no. Article no. Actuating voltage 220V 50Hz	Standard package
		220V	380V	660V*				
Screw terminals	7	2.2	3	3.5	20		XTCG007B00DT 167984	1 piece
Screw terminals	9	2.5	4	4.5	20		XTCG009B00DT 167994	1 piece
Screw terminals	12	3.5	5.5	5.5	20		XTCG012B00DT 168004	1 piece
Screw terminals	18	5	7.5	7.5	25		XTCG018C00DT 168014	1 piece
Screw terminals	25	7.5	11	11	35		XTCG025C00DT 168024	1 piece
Screw terminals	32	10	15	15	40		XTCG032C00DT 168034	1 piece
Screw terminals	38	11	18.5	22	40		XTCG038C00DT 174459	1 piece
Screw terminals	40	12.5	18.5	22	60		XTCG040D00DT 172214	1 piece
Screw terminals	50	15.5	22	30	70		XTCG050D00DT 172224	1 piece
Screw terminals	65	20	30	37	80		XTCG065D00DT 172234	1 piece
Bolts terminals	80	25	37	37	110		XTCG080E00DT 172244	1 piece
Bolts terminals	95	30	45	45	120		XTCG095E00DT 172254	1 piece

* 40-95A is 690V.

Auxiliary contact modules

Connection type	Conventional thermal current open, 40 °C I _{th} = I _e AC-1 A	Contact		Circuit symbol	Can be combined with control relay	Part no. Article no.	Standard package	
		N/O=Normally open	N/C=Normal closed					
Screw terminals	1 pole	10	1 N/O	-		XTCG007B00.. XTCG009B00..	XTCGXFAC10 167939	1 piece
			-	1 N/C		XTCG012B00.. XTCG018C00..	XTCGXFAC01 167940	1 piece
Screw terminals	2 pole	10	2 N/O	-		XTCG025C00.. XTCG032C00..	XTCGXFAC20 167941	1 piece
			1 N/O	1 N/C		XTCG038C00.. XTCG040D00..	XTCGXFAC11 167942	1 piece
Screw terminals	2 pole	10	-	2 N/C		XTCG065D00.. XTCG080E00.. XTCG095E00..	XTCGXFAC02 167943	1 piece
Screw terminals	2 pole	10	1 N/O	1 N/C		XTCG040D00.. XTCG050D00.. XTCG065D00.. XTCG080E00.. XTCG095E00..	XTCGXSAE11 172260	1 piece

Top mounting

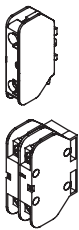

Side mounting



1

Actuating voltages

Coil voltage	7A	9A	12A	18A	25A	32A	38A
24VAC 50Hz	XTCCG007B00B5 167980	XTCCG009B00B5 167990	XTCCG012B00B5 168000	XTCCG018C00B5 168010	XTCCG025C00B5 168020	XTCCG032C00B5 168030	XTCCG038C00B5 174455
36VAC 50Hz	XTCCG007B00DS 167981	XTCCG009B00DS 167991	XTCCG012B00DS 168001	XTCCG018C00DS 168011	XTCCG025C00DS 168021	XTCCG032C00DS 168031	XTCCG038C00DS 174456
48VAC 50Hz	XTCCG007B00C5 167982	XTCCG009B00C5 167992	XTCCG012B00C5 168002	XTCCG018C00C5 168012	XTCCG025C00C5 168022	XTCCG032C00C5 168032	XTCCG038C00C5 174457
110VAC 50Hz	XTCCG007B00E5 167983	XTCCG009B00E5 167993	XTCCG012B00E5 168003	XTCCG018C00E5 168013	XTCCG025C00E5 168023	XTCCG032C00E5 168033	XTCCG038C00E5 174458
220VAC 50Hz	XTCCG007B00DT 167984	XTCCG009B00DT 167994	XTCCG012B00DT 168004	XTCCG018C00DT 168014	XTCCG025C00DT 168024	XTCCG032C00DT 168034	XTCCG038C00DT 174459
380VAC 50Hz	XTCCG007B00DU 167987	XTCCG009B00DU 167997	XTCCG012B00DU 168007	XTCCG018C00DU 168017	XTCCG025C00DU 168027	XTCCG032C00DU 168037	XTCCG038C00DU 174462
24VAC 50/60Hz	XTCCG007B00B2 177208	XTCCG009B00B2 177214	XTCCG012B00B2 177220	XTCCG018C00B2 177226	XTCCG025C00B2 177232	XTCCG032C00B2 177238	XTCCG038C00B2 177639
36VAC 50/60Hz	XTCCG007B00DV 177242	XTCCG009B00DV 177243	XTCCG012B00DV 177244	XTCCG018C00DV 177245	XTCCG025C00DV 177246	XTCCG032C00DV 177247	XTCCG038C00DV 177640
48VAC 50/60Hz	XTCCG007B00C2 177209	XTCCG009B00C2 177215	XTCCG012B00C2 177221	XTCCG018C00C2 177227	XTCCG025C00C2 177233	XTCCG032C00C2 177192	XTCCG038C00C2 177641
110VAC 50/60Hz	XTCCG007B00E2 177210	XTCCG009B00E2 177216	XTCCG012B00E2 177222	XTCCG018C00E2 177228	XTCCG025C00E2 177234	XTCCG032C00E2 177193	XTCCG038C00E2 177642
220VAC 50/60Hz	XTCCG007B00A0 177205	XTCCG009B00A0 177211	XTCCG012B00A0 177217	XTCCG018C00A0 177223	XTCCG025C00A0 177229	XTCCG032C00A0 177235	XTCCG038C00A0 177643
380VAC 50/60Hz	XTCCG007B00AR 177206	XTCCG009B00AR 177212	XTCCG012B00AR 177218	XTCCG018C00AR 177224	XTCCG025C00AR 177230	XTCCG032C00AR 177236	XTCCG038C00AR 177644
24VDC	XTCCG007B00B0 177207	XTCCG009B00B0 177213	XTCCG012B00B0 177219	XTCCG018C00B0 177225	XTCCG025C00B0 177231	XTCCG032C00B0 177237	XTCCG038C00B0 177194

40A	50A	65A	80A	95A
XTCG040D00B5 172210	XTCG050D00B5 172220	XTCG065D00B5 172230	XTCG080E00B5 172240	XTCG095E00B5 172250
XTCG040D00DS 172211	XTCG050D00DS 172221	XTCG065D00DS 172231	XTCG080E00DS 172241	XTCG095E00DS 172251
XTCG040D00C5 172212	XTCG050D00C5 172222	XTCG065D00C5 172232	XTCG080E00C5 172242	XTCG095E00C5 172252
XTCG040D00E5 172213	XTCG050D00E5 172223	XTCG065D00E5 172233	XTCG080E00E5 172243	XTCG095E00E5 172253
XTCG040D00DT 172214	XTCG050D00DT 172224	XTCG065D00DT 172234	XTCG080E00DT 172244	XTCG095E00DT 172254
XTCG040D00DU 172217	XTCG050D00DU 172227	XTCG065D00DU 172237	XTCG080E00DU 172247	XTCG095E00DU 172257
XTCG040D00B2 177645	XTCG050D00B2 177651	XTCG065D00B2 177657	XTCG080E00B2 177663	XTCG095E00B2 177669
XTCG040D00DV 177646	XTCG050D00DV 177652	XTCG065D00DV 177658	XTCG080E00DV 177664	XTCG095E00DV 177670
XTCG040D00C2 177647	XTCG050D00C2 177653	XTCG065D00C2 177659	XTCG080E00C2 177665	XTCG095E00C2 177671
XTCG040D00E2 177648	XTCG050D00E2 177654	XTCG065D00E2 177660	XTCG080E00E2 177666	XTCG095E00E2 177672
XTCG040D00AO 177649	XTCG050D00AO 177655	XTCG065D00AO 177661	XTCG080E00AO 177667	XTCG095E00AO 177673
XTCG040D00AR 177650	XTCG050D00AR 177656	XTCG065D00AR 177662	XTCG080E00AR 177668	XTCG095E00AR 177674
XTCG040D00B0 177195	XTCG050D00B0 177196	XTCG065D00B0 177197	XTCG080E00B0 177198	XTCG095E00B0 177199

General

XT Basic device			CG007	CG009	CG012	CG018	CG025	CG032
Standards			IEC/EN 60947, GB 14048					
Lifespan, mechanical								
AC operated	Operations	x 10 ⁶	10	10	10	10	10	10
Operating frequency								
AC operated	Operations/h		3600	3600	3600	3600	3600	3600
Climatic Proofing			Damp heat, constant, to IEC60068-2-78 Damp heat, cyclic, to IEC60068-2-30					
Ambient temperature								
Operation		°C	-25-55	-25-55	-25-55	-25-55	-25-55	-25-55
Storage		°C	-40-80	-40-80	-40-80	-40-80	-40-80	-40-80
Protection type			IP20	IP20	IP20	IP20	IP20	IP20
Weight		kg	0.17	0.17	0.17	0.35	0.35	0.35
Terminal capacity of main cable								
Solid/stranded		AWG						
Terminal capacity of control circuit cable		mm ²	0.75-2.5	0.75-2.5	0.75-2.5	0.75-2.5	0.75-2.5	0.75-2.5
Main cable connection screws / bolts			M3.5	M3.5	M3.5	M5	M5	M5
Tightening torque		Nm	0.8	0.8	0.8	2	2	2
Control circuit cable connection screws			M3.5	M3.5	M3.5	M3.5	M3.5	M3.5
Tightening torque		Nm	0.8	0.8	0.8	0.8	0.8	0.8
Main contacts								
Rated impulse withstand voltage		U _{imp} V AC	6000	6000	6000	6000	6000	6000
Overvoltage category / pollution degree			III/3	III/3	III/3	III/3	III/3	III/3
Rated insulation voltage		U _i V AC	690	690	690	690	690	690
Rated operational voltage		U _e V AC	660	660	660	660	660	660
Making capacity (cos φ to IEC/EN60947)		380V A	70	90	120	180	250	320
Breaking capacity (cos φ to IEC/EN60947)		380V A	56	72	96	144	200	256
Electrical lifespan								
AC-3		Op.	1,500,000	1,500,000	1,500,000	1,000,000	1,000,000	1,000,000
AC-4		Op.	100,000	100,000	100,000	100,000	100,000	100,000
Magnet systems								
Voltage tolerance AC operated		Pick-up x U _c	0.85-1.1	0.85-1.1	0.85-1.1	0.85-1.1	0.85-1.1	0.85-1.1
Power consumption of coil in a cold state and 1.0 xU_c		Pick-up VA	30	30	30	80	80	80
		Sealing VA	6	6	6	8.1	8.1	8.1
		Sealing W	2	2	2	2.4	2.4	2.4
Power consumption of coil in a cold state and 1.0 xU_c (50/60Hz)		50Hz Pick-up VA	35	35	35	85	85	85
		50Hz Sealing VA	6.5	6.5	6.5	8.5	8.5	8.5
		50Hz Sealing W	2.3	2.3	2.3	2.6	2.6	2.6
Power consumption of coil in a cold state and 1.0 xU_c (50/60Hz)		60Hz Pick-up VA	30	30	30	80	80	80
		60Hz Sealing VA	6	6	6	8.1	8.1	8.1
		60Hz Sealing W	2.1	2.1	2.1	2.5	2.5	2.5
Power consumption of coil in a cold state and 1.0 xU_c (24VDC)		Pick-up VA	12	12	12	12	12	12
		Sealing W	3	3	3	3	3	3

CG038	CG040	CG050	CG065	CG080	CG095
IEC/EN 60947, GB 14048					
10	5	5	5	5	5
3600	3600	3600	3600	3600	3600
Damp heat, constant, to IEC60068-2-78 Damp heat, cyclic, to IEC60068-2-30					
-25-55	-25-55	-25-55	-25-55	-25-55	-25-55
-40-80	-40-80	-40-80	-40-80	-40-80	-40-80
IP20	IP20	IP20	IP20	IP20	IP20
0.35	0.76	0.76	0.76	1.25	1.25
0.75-2.5	0.75-2.5	0.75-2.5	0.75-2.5	0.75-2.5	0.75-2.5
M5	M6	M6	M6	M8	M8
2	2.5	2.5	2.5	6	6
M3.5	M3.5	M3.5	M3.5	M3.5	M3.5
0.8	0.8	0.8	0.8	0.8	0.8
6000	6000	6000	6000	6000	6000
III/3	III/3	III/3	III/3	III/3	III/3
690	690	690	690	690	690
660	690	690	690	690	690
320	400	500	650	800	950
256	320	400	520	640	760
1,000,000	900,000	900,000	900,000	900,000	900,000
100,000					
0.85-1.1	0.85-1.1	0.85-1.1	0.85-1.1	0.85-1.1	0.85-1.1
80	190	190	190	300	300
8.1	20	20	20	26	26
2.4	4	4	4	6	6
85	220	220	220	350	350
8.5	21	21	21	34	34
2.6	6	6	6	9	9
80	200	200	200	300	300
8.1	20	20	20	26	26
2.5	5	5	5	8	8
12	65	65	65	90	90
3	4	4	4	5	5

1

Auxiliary contact

			XTCGXFAC..	XTCGXSAE11
Rated impulse withstand voltage	U_{imp}	VAC	6000	6000
Overvoltage category/degree of pollution			III/3	III/3
Rated insulation voltage	U_i	VAC	690	690
Rated operational voltage	U_e	VAC	660	690
Rated operational current				
AC-15				
120V	I_e	A	6	6
240V	I_e	A	4	4
380V	I_e	A	1.9	1.9
DC-13				
125V	I_e	A	0.55	0.55
250V	I_e	A	0.27	0.27
Conventional thermal current	I_{th}	A	10	10
Electrical lifespan				
at $U_e=230V$, AC-15, 3A		Operations	$\times 10^6$	1

Terminals

7-12A

	mm^2	mm^2	Nm	Aux Contact mm^2	Nm
	0.75 - 2.5	0.75 - 2.5	0.8	0.75 - 2.5	0.8
	0.75 - 2.5	0.75 - 2.5			

18-38A

	mm^2	mm^2	Nm	Aux Contact mm^2	Nm
	1 - 6 (1 - 10)*	1 - 6 (1 - 10)*	2	0.75 - 2.5	0.8
	1 - 4 (1 - 10)*	1 - 4 (1 - 10)*			

40-65A

	mm^2	mm^2	Nm	Aux Contact mm^2	Nm
	2.5 - 25	2.5 - 16	2.5	0.75 - 2.5	1.2
	2.5 - 25	2.5 - 16			

80-95A

	mm^2	mm^2	Nm	Aux Contact mm^2	Nm
	6 - 50	6 - 25	6	0.75 - 2.5	1.2
	6 - 50	6 - 25			

* Only for XTCG032...

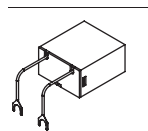

Coil surge suppressor (7-38A)

Coil voltage	RC	Varistor
24-48V	XTCGXRSCN2 167946	XTCGXVSCN2 167949
110-220V	XTCGXRSCDV 167947	XTCGXVSCDV 167950
380-440V	XTCGXRSCCM 167948	XTCGXVSCCM 167951

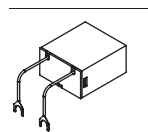

Coil surge suppressor (40-95A)

Coil voltage	RC	Varistor
24V	XTCGXRSEB5 174132	XTCGXVSEB5 177204
36V	XTCGXRSEDS 174133	XTCGXVSEDS 177239
48V	XTCGXRSEC5 174134	XTCGXVSEC5 177201
110V	XTCGXRSEE5 174129	XTCGXVSEE5 177203
220V	XTCGXRSEDT 174135	XTCGXVSEDT 174142
380V	XTCGXRSEDU 174136	XTCGXVSEDU 174143

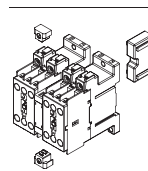

Mechanical interlock

7-12A	18-38A	40-65A	80-95A
XTCGXMLB 167944	XTCGXMLC 167945	XTCGXMLD 172261	XTCGXMLE 172262

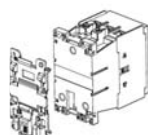

Din rail plate

80-95A
XTCGXMPE 172908

Contactors

7-12A Frame

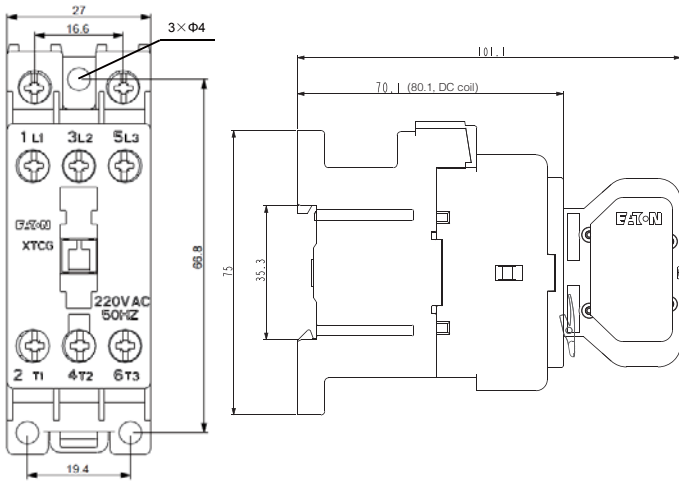

18-38A Frame

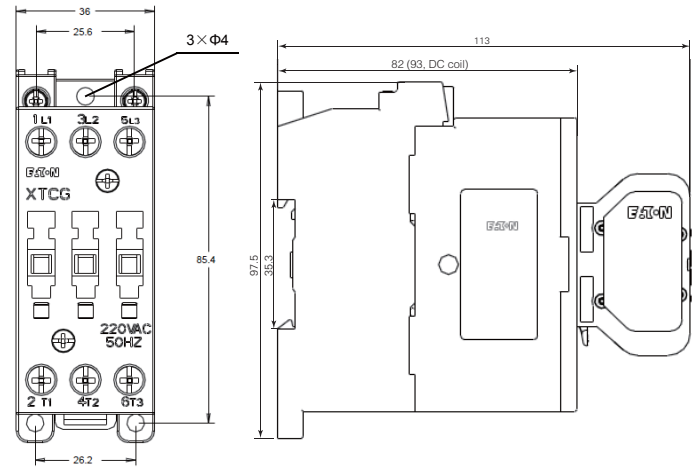

40-65A Frame

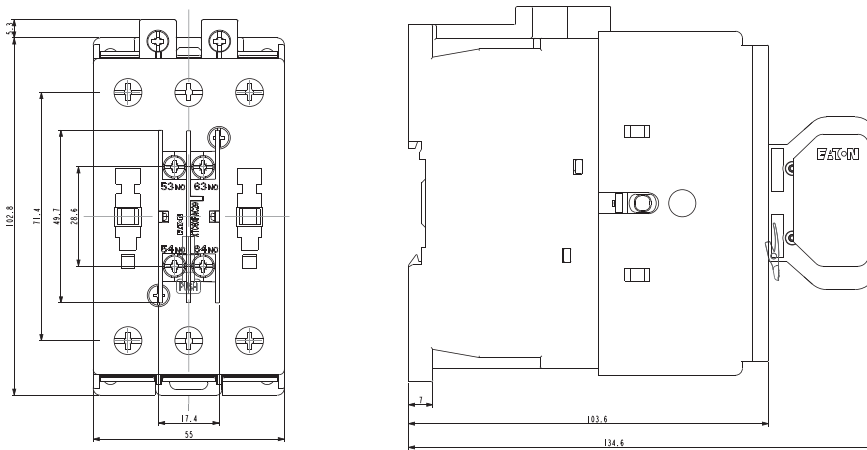

80-95A Frame

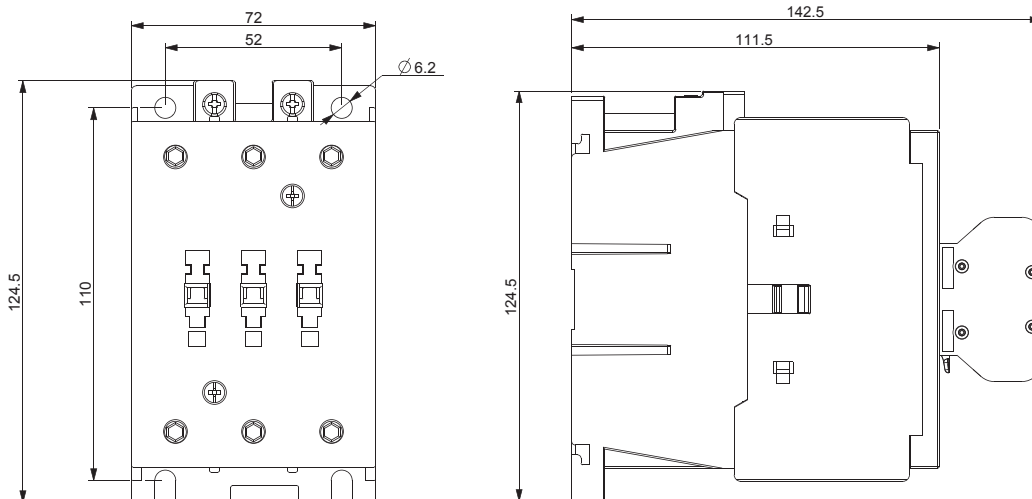

1.1

Contactors Dimensions

1

Auxiliary contact module

1 Pole

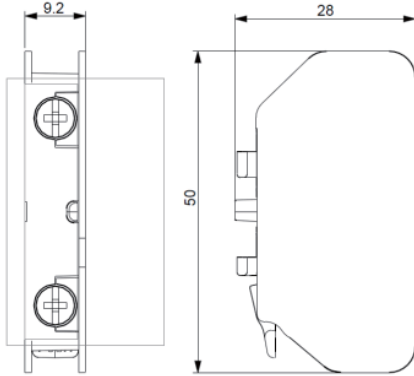

2 Pole

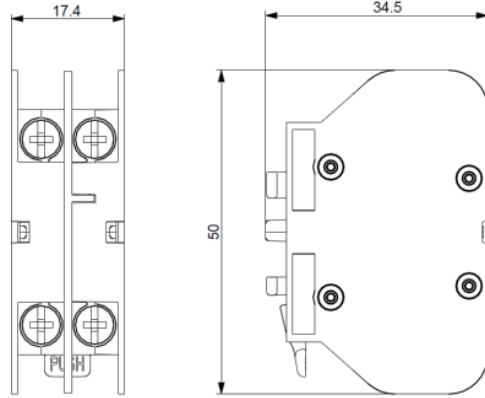

Side mounting contact module

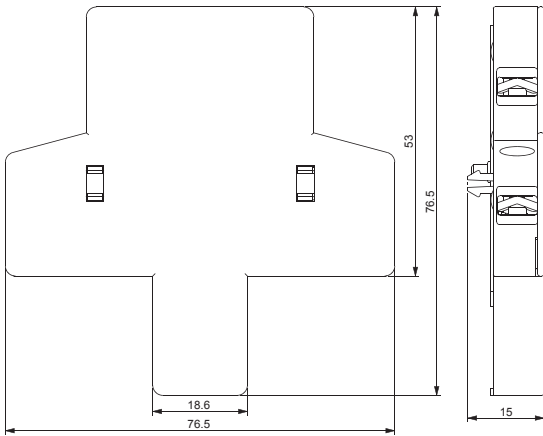

Control Relay

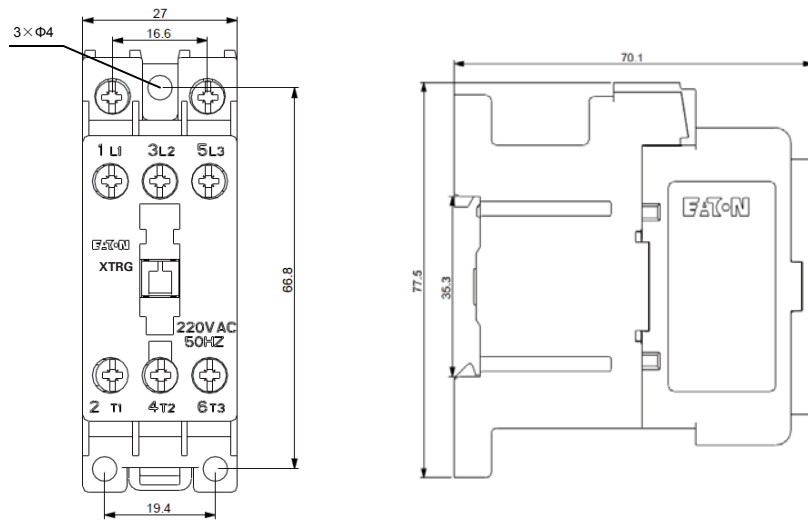

Surge suppressor

7-38A Surge suppressor

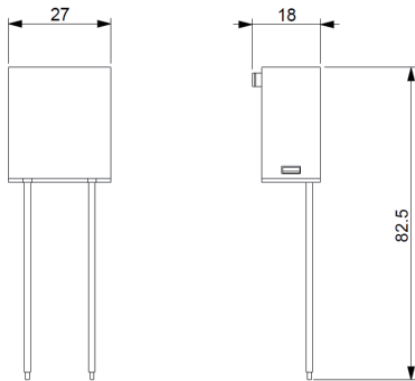

40-95A Surge suppressor

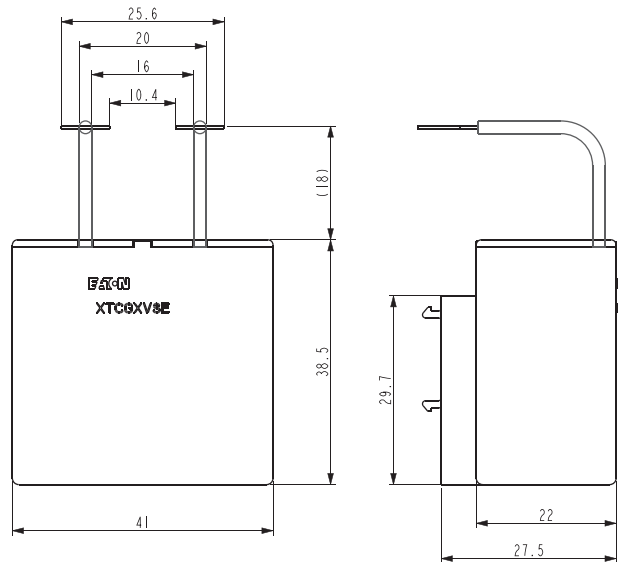

1.1

Contactors Dimensions

1

Mechanical interlock

7-12A Frame

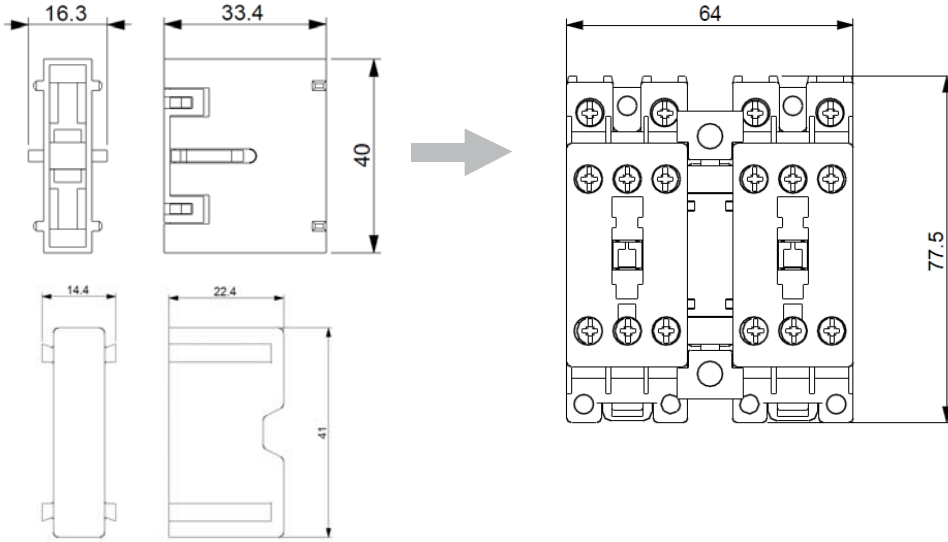

18-38A Frame

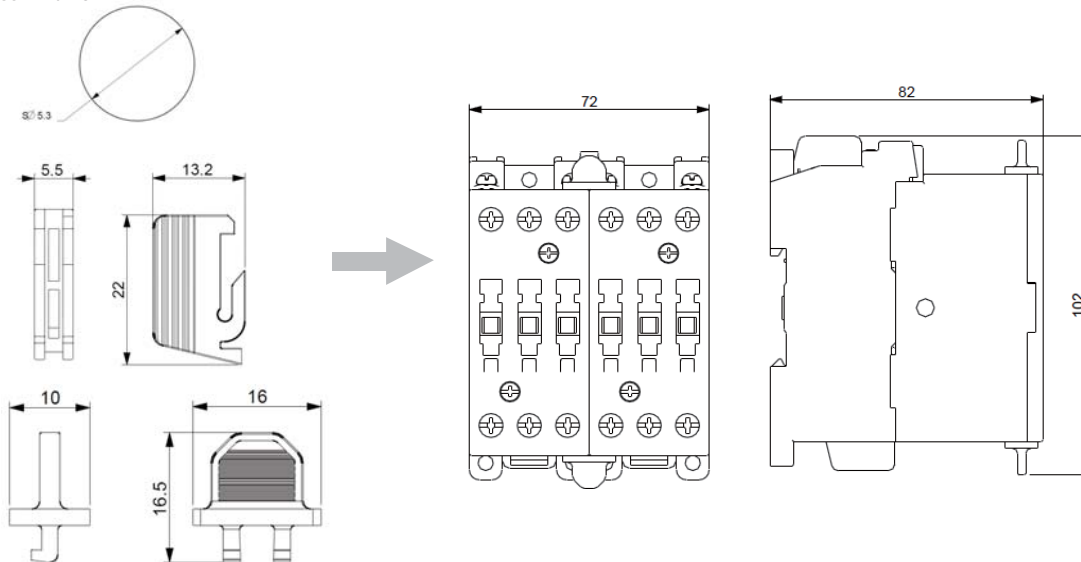

Mechanical interlock
40-65A Frame

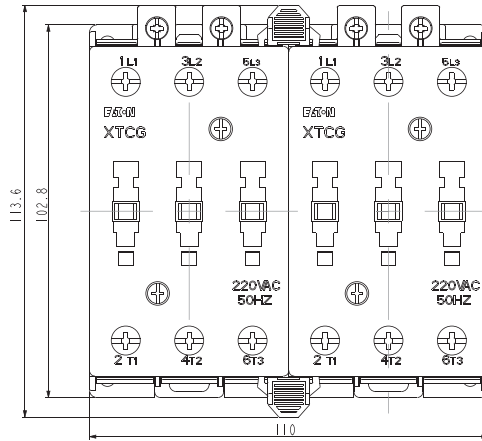
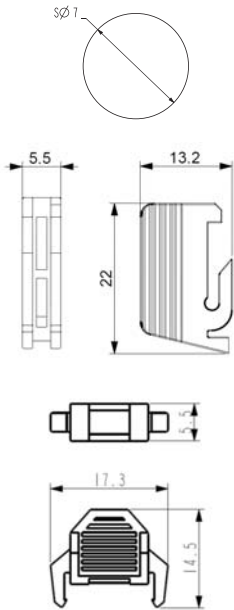

80-95A Frame

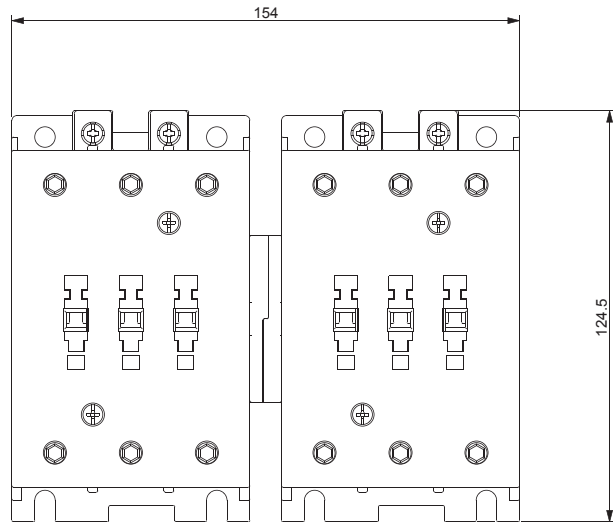
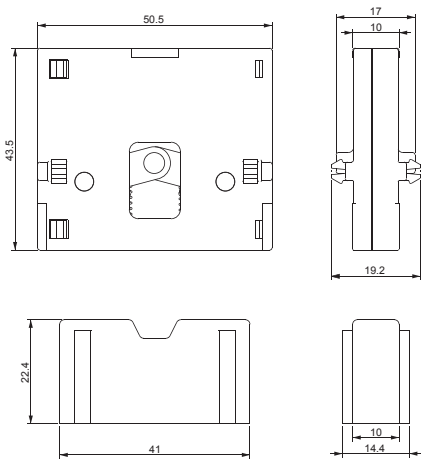



Mini contactor relays, contactor relay, contactors

Continual operation requires high operational reliability in the components used. The DILM contactor achieves the best lifespan values in AC-3 applications and is ideal for heavy AC-4 jogging.

Mini contactor relay DILE..., contactor relays, contactors up to 12 A AC-3 at 400 V

- Compact dimensions for the highest packing densities
- Extended performance range up to 5.5 kW at 400 V

AC and DC contactor system DILM..., contactor relays, 3 pole contactors up to 170 A AC-3 at 400 V, 4 pole contactors up to 200 A AC-1

- Easier engineering through identical construction sizes for AC- and DC-operated contactors
- Energy savings and higher packing density in control panel due to minimized heat dissipation
- High wiring security through doubled box terminals
- Less coupler relays: direct actuation from the PLC for contactors up to 32 A
- Easy engineering through integrated suppressor circuits for DC
- Uniform accessories for 3- and 4-pole contactors
- Mechanical interlock double conductor run mountable without additional separation gap
- Direct fieldbus connection through the communication system SmartWire-DT®, through plug-in type protective module



Eaton after sales service

Testing switching devices in compliance with regulations applicable to this technology
→ See catalog

High rated contactors - contactors up to 1600 A AC-3 at 400 V, contactors up to 2600 A AC-1

- Compact dimensions with high switching power
- Direct actuation from the PLC saves coupler relays
- Easy engineering through wide range coils
- Cost and energy savings for control panel ventilation due to reduced heat dissipation
- Long lifespan through vacuum technology from 580 A



SmartWire-DT®

The DIL product range offers contact elements which can be connected to the SmartWire-DT® communication system. → Protective modules, Page 62

Mini contactor relays, contactor relay, contactors DIL

Contents

1

Mini contactor relays, contactor relay, contactors DIL



Contents

<i>Description</i>	<i>Page</i>
Ordering	
Mini contactor relays DILER, DILEEM, DILEM	
Mini contactor relays, contactors	2
Auxiliary contact modules	6
Accessories	8
Actuating voltages	66
DILA contactor relays	
Contactor relays	10
Auxiliary contact modules	12
Actuating voltages	68
Technical overview	
Contactors DILM, DILH	14
System overview	
Contactors DILM, DILH	16
Ordering	
Contactors DILM, DILH	
Basic devices up to 170 A	18
Complete units up to 170 A	24
Standard devices greater than 170 A	28
Comfort devices greater than 170 A	30
Basic devices up to 200 A, 4 pole	34
Auxiliary contact modules	36
Engineering	
Auxiliary contact modules	40
Ordering	
DILK contactors for capacitors	41
Engineering	
Contactors for power factor correction	42
Ordering	
Star-delta combinations SDAINL	44
Engineering	
Star-delta combinations SDAINL	46
Ordering	
DIUL reversing combinations	48
Description	
CMD contactor monitoring device	64
Ordering	
CMD contactor monitoring device	64

Mini contactor relays, contactor relay, contactors DIL



Contents

<i>Description</i>	<i>Page</i>
Ordering	
DILM contactor relays, DILM, DILH contactors	
suppressor circuit	50
Accessories	52
Ordering	
Actuating voltages contactors DILM, DILH	
Basic devices up to 170 A	69
Basic devices up to 200 A, 4 pole	74
Contactors up to 150 A with electronic actuation	76
Replacement coils	71
Comfort devices greater than 170 A	77
Standard devices greater than 170 A	77
Electronic modules including coil	77
Contactors for capacitors	77
Engineering	
Contact travel diagrams	78
Enclosure	79
UL/CSA-Approved rating data	80
UL/CSA Special Purpose Ratings	81
UL/CSA Short Circuit Current Rating	82
Contactors for resistive loads	84
Electrical life span	86
Short-time loading	90
Operating frequency	91
Switching of DC current	92
Technical data	
Mini contactor relays, contactor relays	93
Contactor monitoring device	96
Basic devices up to 170 A	104
Basic devices up to 200 A, 4 pole	120
Comfort devices greater than 170 A	112
Standard devices greater than 170 A	112
Contactors for capacitors	123
Contactors up to 150 A with electronic actuation	126
Lighting contactors	125
Auxiliary contact modules	128
Accessories	128
Dimensions	
Mini contactor relays	130
Contactor relays	131
Basic devices up to 170 A	131
Basic devices up to 200 A, 4 pole	133
Contactors larger than 170 A	134
Contactors for capacitors	136
Lighting contactors	136
Contactor combinations	137
Accessories	138

1.2

Contactors

Mini contactors, relays

1 Ordering

Screw terminals

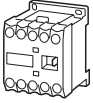

DILER mini contactor relays

Rated operational current AC-15		Conventional free air thermal current	Contact		Distinctive number	Circuit symbol	For use with
220 V	380 V		N/O = normally open contact	NC = normally closed contact			
230 V	400 V						
240 V	415 V						
I_e	I_e	I_{th}					
A	A		A				
6	3	10	4 N/O	–	40E		DILE...
			3 N/O	1 NC	31E		DILE...
			2 N/O	2 NC	22E		DILE...

Notes

- Coil terminal marking as specified in EN 50005
- Contact numbers to EN 50011
- The following applies to DC-operated contactors:
 - Integrated diode-resistor combination
 - Coil rating 2.6 W

Information relevant for export to North America



Product Standards	IEC/EN 60947-4-1; UL508; CSA-C22.2 No.14-05;
UL File No.	E29184
UL CCN	NKCR
CSA File No.	012528
CSA Class No.	3211-03
NA Certification	UL Listed, CSA certified

AC operation		DC operation		Std. pack	Notes
Part no.	Price	Part no.	Price		
Article no.	See price list	Article no.	See price list		

DILER-40(230V50Hz) 051759	DILER-40-G(24VDC) 010223	5 off	
DILER-31(230V50Hz) 051768	DILER-31-G(24VDC) 010157		
DILER-22(230V50Hz) 051777	DILER-22-G(24VDC) 010042		

With screw terminals:

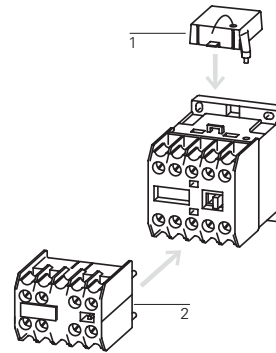

Accessories

- 1 Suppressor
- 2 Auxiliary contact modules
- Further actuating voltages

Page

- 8
- 6
- 66

1.2

Contactors

Mini contactors, relays

1

DILEM contactors

Rated operational current	Max. motor rating for three-phase motors, 50 - 60 Hz						Conventional thermal current $I_{th} = I_e$ AC-1 at 50 °C		Contact		Circuit symbol	For use with
	AC-3			AC-4			Open	Enclosed	N/O = normally open contact NC = normally closed contact			
380 V 400 V I_e	220 V 230 V P	380 V 400 V P	660 V 690 V P	220 V 230 V P	380 V 400 V P	660 V 690 V P	$I_{th} = I_e$	$I_{th} = I_e$				
A	kW	kW	kW	kW	kW	kW	A	A				
6.6	1.5	3	3	1.1	2.2	2.2	20	16	1 N/O	–		...DILEM DILE...
6.6	1.5	3	3	1.1	2.2	2.2	20	16	–	1 NC		DILE...
9	2.2	4	4	1.5	3	3	20	16	1 N/O	–		...DILEM DILE...
9	2.2	4	4	1.5	3	3	20	16	–	1 NC		DILE...
12	3.5	5.5	6.5	2	3	2.2	20	16	1 N/O	–		...DILEM DILE...
12	3.5	5.5	6.5	2	3	2.2	20	16	–	1 NC		DILE...
9	2.2	4	4	1.5	3	3	20	16	–	–		...DILEM DILE...

3 pole with auxiliary contact
Screw terminals

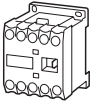

4 pole
Screw terminals

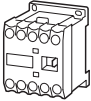

1)

Information relevant for export to North America



Product Standards IEC/EN 60947-4-1;
UL 508; CSA-C22.2
No.14-05; CE marking
UL File No. E29096
UL CC NLDX
CSA File No. 012528
CSA Class No. 3211-04
NA Certification UL Listed, CSA certified
See also → Page 80



2)

Information relevant for export to North America



Product Standards IEC/EN 60947-4-1;
UL 508; CSA-C22.2 No.14-05; CE marking
UL File No. E29096
UL CCN NLDX
CSA File No. 012528
CSA Class No. 2411-03,3211-04
NA Certification UL Listed, request filed for CSA

AC operation		DC operation		Std. pack	Notes
Part no. Article no.	Price See price list	Part no. Article no.	Price See price list		

DILEEM-10(230V50Hz) ¹⁾ 051608	DILEEM-10-G(24VDC) ¹⁾ 051643	5 off	
DILEEM-01(230V50Hz) ¹⁾ 051633	DILEEM-01-G(24VDC) ¹⁾ 051650		
DILEM-10(230V50Hz) ¹⁾ 051786	DILEM-10-G(24VDC) ¹⁾ 010213		
DILEM-01(230V50Hz) ¹⁾ 051795	DILEM-01-G(24VDC) ¹⁾ 010343		
DILEM12-10(230V50Hz) ²⁾ 127075	DILEM12-10-G(24VDC) ²⁾ 127132		
DILEM12-01(230V50Hz) ²⁾ 127091	DILEM12-01-G(24VDC) ²⁾ 127137		
DILEM4(230V50Hz) ¹⁾ 051804	DILEM4-G(24VDC) ¹⁾ 012701	5 off	

With screw terminals:

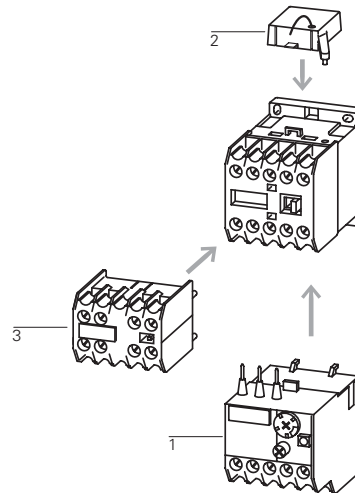

Accessories

- 1 Overload relay
- 2 Suppressor
- 3 Auxiliary contact module
- Enclosures totally insulated
- Further actuating voltages
- Accessories

Page

- Chapter 1.2
- 8
- 6
- 66
- 8

1.2

Mini contactor relays

Auxiliary contact modules

1

Screw terminals













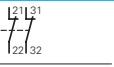

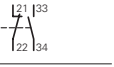

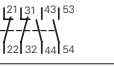

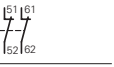

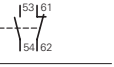

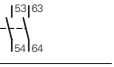

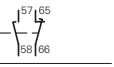

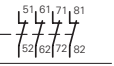

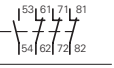

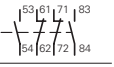
DILE Auxiliary contact modules

	Contact				Rated operational current		Conventional thermal current I_{th} A	Distinctive number/type of combinations with basic device		
	N/O	S _F	NC	Ö _S	AC-15 220 V 230 V 240 V	380 V 400 V 415 V		DILER-40(-G)	DILER-31(-G)	DILER-22
2 pole	–	–	2 NC	–	4	2	10	–	–	–
	1 N/O	–	1 NC	–	4	2	10	–	–	–
4 pole	2 N/O	–	2 NC	–	4	2	10	–	–	–
2 pole	–	–	2 NC	–	4	2	10	42E	33	24
	1 N/O	–	1 NC	–	4	2	10	51E	42	33
	2 N/O	–	–	–	4	2	10	60E	51	42
	–	1 S _F	–	1 Ö _S	4	2	10	51	42	33
4 pole	–	–	4 NC	–	4	2	10	44E	35	26
	1 N/O	–	3 NC	–	4	2	10	53E	44	35
	2 N/O	–	2 NC	–	4	2	10	62E	53	44
	3 N/O	–	1 NC	–	4	2	10	71E	62	53
	4 N/O	–	–	–	4	2	10	80E	71	62
	1 N/O	1 S _F	1 NC	1 Ö _S	4	2	10	62	53	44

Information relevant for export to North America

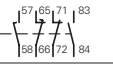

Product Standards	IEC/EN 60947-4-1; UL 508; CSA-C22.2 No.14-05; CE marking
UL File No.	E29184
UL CCN	NKCR
CSA File No.	012528
CSA Class No.	3211-03
NA Certification	UL Listed, CSA certified

Circuit symbol	Can be combined with contactor	Part no. Article no.	Price See price list	Std. pack	Notes
		02DILEM 010064	5 off	 	With interlocked opposing contacts
		11DILEM 010080	5 off	 	With interlocked opposing contacts
		22DILEM 010112	5 off	 	With interlocked opposing contacts
		02DILE 010240	5 off	 	With interlocked opposing contacts
		11DILE 010224	5 off	 	With interlocked opposing contacts
		20DILE 010208	5 off	 	With interlocked opposing contacts
		11DDILE 049824	5 off	 	–
		04DILE 010256	5 off	 	With interlocked opposing contacts
		13DILE 002397	5 off	 	With interlocked opposing contacts
		22DILE 010288	5 off	 	With interlocked opposing contacts
		31DILE 048912	5 off	 	With interlocked opposing contacts
		40DILE 010304	5 off	 	With interlocked opposing contacts
		22DDILE 049823	5 off	 	–

The following applies to ...DILEM auxiliary contacts:

- Contacts to EN 50012
- The following applies to ...DILE auxiliary contacts:
- Contacts to EN 50005

Contacts according to EN50012 are to be preferred. Type E combinations comply with EN 50011 and are to be given preference.

No interlocked opposing contacts in NO early-makes and NC late-breaks.

1.2 Mini contactor relays

Accessories

1 VGDILE..., RCDILE..., MVDILE, BT480, P1DILEM

Actuating voltage U_s V AC	Circuit symbol	For use with	Part no. Article no.	Price See price list	Std. pack	Information relevant for export to North America
------------------------------------	----------------	--------------	-------------------------	-------------------------	-----------	--

Suppressor circuits

Varistor suppressor

	24 - 48 AC		DILE...	VGDILE48 010320	10 off 	Product Standards IEC/EN 60947-4-1; UL 508; CSA-C22.2 No.14-05; CE marking E29096 UL File No. UL CCN CSA File No. CSA Class No. NA Certification
	110 - 250 AC		VGDILE250 010336	10 off 		
	380 - 415 AC		VGDILE415 010463	10 off 		

RC-Suppressor

	24 - 48 AC		DILE...	RCDILE48 044264	10 off 	Product Standards IEC/EN 60947-4-1; UL 508; CSA-C22.2 No.14-05; CE marking E29184 UL File No. UL CCN CSA File No. NA Certification
	110 - 250 AC		RCDILE250 046320	10 off 	UL Recognized	

Notes
For AC operated contactors 50 - 60 Hz.
DC operated contactor relays have an integrated suppressor.
Note drop-out delay.

VGDILE..., RCDILE..., MVDILE, BT480, P1DILEM

For use with	Part no. Article no.	Price See price list	Std. pack	Information relevant for export to North America
--------------	-------------------------	-------------------------	-----------	--

Mechanical interlocks

For mechanical connection of contactor and timing relays in combinations.
0 mm distance between contactors.

	DILE... DILET...	VODILE 026634	50 off 	UL/CSA certification not required
--	---------------------	-------------------------	------------	-----------------------------------

Mechanical interlock

For contactors with the same or different magnet system.
0 mm distance between contactors.
Mechanical lifespan 2.5×10^6 operations.
Additional auxiliary contact modules possible.

	DILE...	MVDILE 010113	5 off 	Product Standards IEC/EN 60947-4-1; UL 508; CSA-C22.2 No.14-05; CE marking E29184 UL File No. UL CCN CSA File No. CSA Class No. NA Certification
				UL Recognized, CSA certified

Paralleling link

For parallel connection of contacts

	DILE... DILE...	BT480 ¹⁾ 052785	100 off	Product Standards IEC/EN 60947-4-1; UL 508; CSA-C22.2 No.14-05; CE marking E29096 UL File No. UL CCN
Consisting of two four-pole paralleling links.				
	DILEEM DILEM12 DILEM	P1DILEM ²⁾ 019095	5 off 	CSA File No. CSA Class No. NA Certification
				UL Listed, CSA certified

Notes
1) Not protected against accidental contact as specified in VDE 0106 Part 100.
2) 4th pole can be broken off
4 pole: $I_{th} = 60$ A open
3 pole: $I_{th} = 50$ A open
AC-1 current carrying capacity of the open contactor increases by a factor of 2.5
Protected against accidental contact in accordance with VDE 0106 Part 100

HDILE, ...DILEM, MVS

Contact sequence	For use with	Part no. Article no.	Price See price list	Std. pack	Information relevant for export to North America
------------------	--------------	-------------------------	-------------------------	-----------	--



Sealable shrouds

Transparent
Snap-fitting on contactor.
Can be used with open installation or on service distribution board.
Protection type: IP40 front
Can be drilled to accommodate timing relay setting dials.

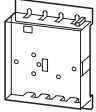

DILE... DILET...	HDILE 010482	1 off 	UL/CSA certification not required
---------------------	------------------------	-----------	-----------------------------------

Start-point bridge



DILEEM DILEM12 DILEM	SDILEM¹⁾ 220218	20 off
----------------------------	--------------------------------------	--------

Reversing starter wiring kit

Main current wiring for reversing combinations

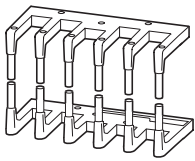

DILEEM (+MVDILEM) DILEM12 (+MVDILEM) DILEM (+MVDILEM)	MVS-WB-EM²⁾ 220209	1 off 	Product Standards IEC/EN 60947-4-1; UL 508; CSA-C22.2 No.14-05; CE marking UL File No. E36332 UL CCN NLRV7 CSA File No. 012528 CSA Class No. 3211-06 NA Certification UL Listed, CSA certified
---	---	-----------	---

Star-delta wiring kit

Main current wiring for star-delta combination incl. star-point bridge

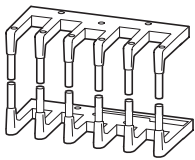

DILE(E)M (+MVDILEM) DILE(E)M12 (+MVDILEM) DILE(E)M star contactor	MVS-SB-EM³⁾ 220213	1 off 	Product Standards IEC/EN 60947-4-1; UL 508; CSA-C22.2 No.14-05; CE marking UL File No. E36332 UL CCN NLRV7 CSA File No. 012528 CSA Class No. 3211-06 NA Certification UL Listed, CSA certified
---	---	-----------	---

Notes

- ¹⁾ Protected against accidental contact in accordance with VDE 0106 Part 100
- ²⁾ The following control cables are integrated in addition to electrical interlock:
 - Q11: A1 - Q12: 21
 - Q11: 21 - Q12: A1
 - Q11: A2 - Q12: A2
 For use with overload relay separate mounting.
- ³⁾ The following control cables are integrated in addition to electrical interlock:
 - Q13: A1 - Q15: 21
 - Q13: 21 - Q15: A1
 - Q13: A2 - Q15: A2
 For use with overload relay separate mounting.

1.2

Contactor relays

Basic devices

1

DILA Basic devices with positively driven contacts

Contact		Rated operational current		Conventional thermal current	Distinctive number	Can be combined with auxiliary contact	Circuit symbol
N/O = normally open contact	NC = normally closed contact	AC-15		I_{th}			
		220 V	380 V	A			
		230 V	400 V				
		240 V	415 V				
		I_e	I_e				
		A	A				
Screw terminals							
4 N/O	–	4	4	16	40E	DILA-XHI(V)...	
3 N/O	1 NC	4	4	16	31E	DILA-XHI(V)...	
2 N/O	2 NC	4	4	16	22E	DILA-XHI(V)...	
Spring-loaded terminals							
4 N/O	–	4	4	16	40E	DILA-XHIC(V)...	
3 N/O	1 NC	4	4	16	31E	DILA-XHIC(V)...	
2 N/O	2 NC	4	4	16	22E	DILA-XHIC(V)...	

Screw terminals

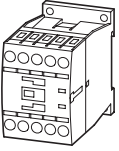

Spring-loaded terminals

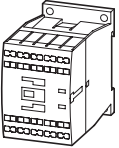

Notes

Contact numbers to EN 50011
Coil terminal markings to EN 50005
The following applies to DC-operated contactors:

- Integrated suppressor circuit

Information relevant for export to North America



Product Standards	IEC/EN 60947-4-1; UL 508; CSA-C22.2 No.14-05; CE marking
UL File No.	E29184
UL CCN	NKCR
CSA File No.	012528
CSA Class No.	3211-03
NA Certification	UL Listed, CSA certified

AC operation

Part no.
Article no.

Price
See price
list

Std. pack

Circuit symbol

DC operation

Part no.
Article no.

Price
See price
list

Std. pack

Notes

DILA-40(230V50Hz)
276329

1 off



DILA-40(24VDC)
276344

1 off

With screw terminals:

DILA-31(230V50Hz)
276364

1 off

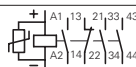

DILA-31(24VDC)
276379

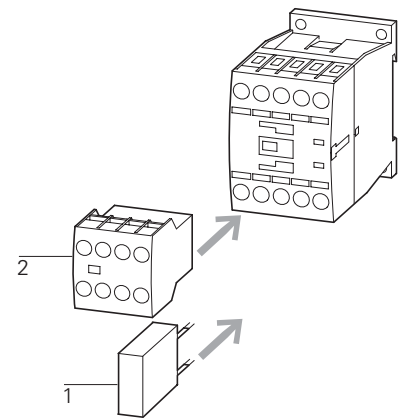

DILA-22(230V50Hz)
276399

1 off

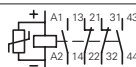

DILA-22(24VDC)
276414

Accessories	Page
1 Suppressor	→ 50
2 Auxiliary contact modules	→ 36
Further actuating voltages	→ 68

DILAC-40(230V50Hz)
276441

1 off



DILAC-40(24VDC)
276456

1 off

With spring-loaded terminals:

DILAC-31(230V50Hz)
276473

1 off

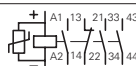

DILAC-31(24VDC)
276488

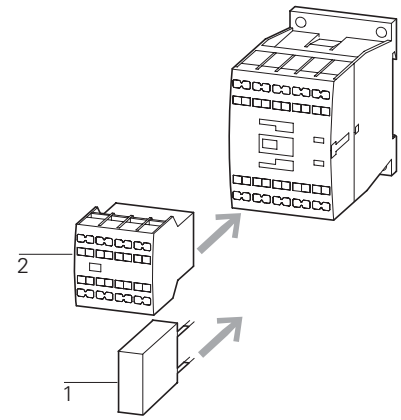

DILAC-22(230V50Hz)
276505

1 off

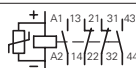

DILAC-22(24VDC)
276520

Accessories	Page
1 Suppressor	→ 50
2 Auxiliary contact modules	→ 36
Further actuating voltages	→ 68

1.2

Contactors relays Auxiliary contact modules

1

DILA...XHI... DILA auxiliary contact modules

Contact	Rated operational current	Conventional thermal current	Circuit symbol
N/O = normally open contact S _F = NO early-make NC = normally closed contact Ö _S = NC late-break	AC-15 220 V 380 V 230 V 400 V 240 V 415 V I _e I _e A A	I _{th} A	

Screw terminals



2 pole	–	–	2 NC	–	4	4	16	
	1 N/O	–	1 NC	–	4	4	16	
	2 N/O	–	–	–	4	4	16	
	–	1 S _F	–	1 Ö _S	4	4	16	

Screw terminals



4 pole	–	–	4 NC	–	4	4	16	
	1 N/O	–	3 NC	–	4	4	16	
	2 N/O	–	2 NC	–	4	4	16	
	3 N/O	–	1 NC	–	4	4	16	
	4 N/O	–	–	–	4	4	16	
	1 N/O	1 S _F	1 NC	1 Ö _S	4	4	16	

Spring-loaded terminals



2 pole	–	–	2 NC	–	4	4	16	
	1 N/O	–	1 NC	–	4	4	16	
	2 N/O	–	–	–	4	4	16	
	–	1 S _F	–	1 Ö _S	4	4	16	

Spring-loaded terminals





















4 pole	–	–	4 NC	–	4	4	16	
	1 N/O	–	3 NC	–	4	4	16	
	2 N/O	–	2 NC	–	4	4	16	
	3 N/O	–	1 NC	–	4	4	16	
	4 N/O	–	–	–	4	4	16	
	1 N/O	1 S _F	1 NC	1 Ö _S	4	4	16	

Information relevant for export to North America



Product Standards	IEC/EN 60947-4-1; UL 508; CSA-C22.2 No.14-05; CE marking
UL File No.	E29184
UL CCN	NKCR
CSA File No.	012528
CSA Class No.	3211-03
NA Certification	UL Listed, CSA certified

Distinctive number/type of combinations			Part no. Article no.	Price See price list	Std. pack	Description	Notes
DILA(C)-40	DILA(C)-31	DILA(C)-22					
42E	33	24	DILA-XHI02 276420		5 off 	With interlocked opposing contacts	Type E combinations comply with EN 50011 and must be given preference. The other combinations comply with EN 50005 The DC operated contactor DILA(C)-22 must only be combined with 2 pole auxiliary contacts.
51E	42	33	DILA-XHI11 276421		5 off 	With interlocked opposing contacts	
60E	51	42	DILA-XHI20 276422		5 off 	With interlocked opposing contacts	
51	42	33	DILA-XHIV11 276423		5 off 	–	
44E	35	26	DILA-XHI04 276424		5 off 	With interlocked opposing contacts	
53E	44	35	DILA-XHI13 276425		5 off 	With interlocked opposing contacts	
62E	53	44	DILA-XHI22 276426		5 off 	With interlocked opposing contacts	
71E	62	53	DILA-XHI31 276427		5 off 	With interlocked opposing contacts	
80E	71	62	DILA-XHI40 276428		5 off 	With interlocked opposing contacts	
62	53	44	DILA-XHIV22 276429		5 off 	–	
42E	33	24	DILA-XHIC02 276526		5 off 	With interlocked opposing contacts	Type E combinations comply with EN 50011 and must be given preference. The other combinations comply with EN 50005 The DC operated contactor DILA(C)-22 must only be combined with 2 pole auxiliary contacts.
51E	42	33	DILA-XHIC11 276527		5 off 	With interlocked opposing contacts	
60E	51	42	DILA-XHIC20 276528		5 off 	With interlocked opposing contacts	
51	42	33	DILA-XHICV11 276529		5 off 	–	
44E	35	26	DILA-XHIC04 276530		5 off 	With interlocked opposing contacts	
53E	44	35	DILA-XHIC13 276531		5 off 	With interlocked opposing contacts	
62E	53	44	DILA-XHIC22 276532		5 off 	With interlocked opposing contacts	
71E	62	53	DILA-XHIC31 276533		5 off 	With interlocked opposing contacts	
80E	71	62	DILA-XHIC40 276534		5 off 	With interlocked opposing contacts	
62	53	44	DILA-XHICV22 276535		5 off 	–	

1.2 Contactors

1 Technical overview

DILM, DILE(E)M, DILMP

Contactors

3 pole

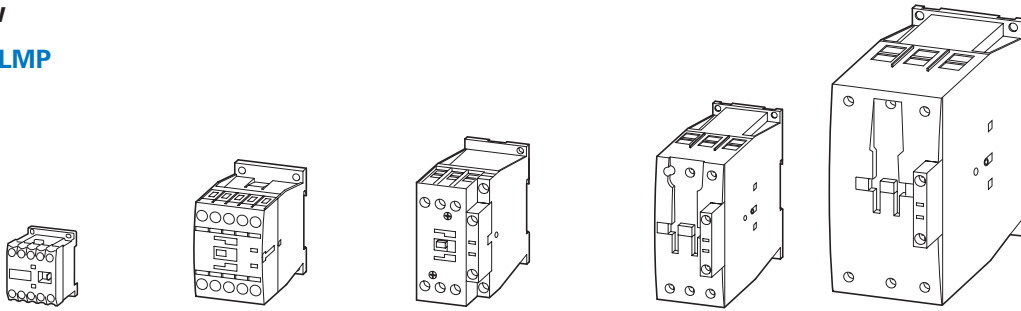

DIL	EEM	EM	EM12	M7	M9	M12	M15	M17	M25	M32	M38	M40	M50	M65	M80	M95	M115	M150	M170
Basic devices	→ 4			→ 18				→ 18				→ 20			→ 46				
Complete units		–		→ Page 24		–		→ Page 24				→ Page 26			→ Page 26				
Rated-operational voltage	kW	kW	kW	kW	kW	kW	kW	kW	kW	kW	kW	kW	kW	kW	kW	kW	kW	kW	kW

AC-3	Rated operational power for 3-phase motors 50–60 Hz																		
220 V – 230 V	1.5	2.2	3	2.2	2.5	3.5	4	5	7.5	10	11	12.5	15.5	20	25	30	37	48	52
380 V – 400 V	3	4	5.5	3	4	5.5	7.5	7.5	11	15	18.5	18.5	22	30	37	45	55	75	90
440 V	3.3	4.6	5.5	4.5	5.5	7.5	8.4	10.5	15.5	20	21	25	32	41	51	60	75	95	105
500 V	3	4	5.5	3.5	4.5	7	7.5	12	17.5	23	24	28	36	47	58	70	85	110	120
660 V/690 V	3	4	4	3.5	4.5	6.5	7	11	14	17	21	23	30	35	63	75	90	96	140
1000 V	–	–	–	–	–	–	–	–	–	–	–	–	–	–	–	–	–	–	–

AC-4	Rated operational power for 3-phase motors 50–60 Hz																		
220 V – 230 V	1.1	1.5	1.5	1	1.5	2	2	2.5	3.5	4	4	5	6	7	12	16	17	20	20
380 V – 400 V	2.2	3	3	2.2	2.5	3	3	4.5	6	7	7	9	10	12	20	26	28	33	33
440 V	2.4	3.3	3.3	2.4	3	3.6	3.6	5.5	7	8	8	10	12	14	25	32	35	41	41
500 V	2.2	3	3	2.5	2.8	3.5	3.5	6	8	9	9	11	13	16	29	36	40	47	47
660 V/690 V	2.2	3	3	2.9	3.6	4.4	4.4	6.5	8.5	10	10	12	14	17	26	35	43	48	48
1000 V	–	–	–	–	–	–	–	–	–	–	–	–	–	–	–	–	–	–	–

AC-1	Rated operational power under resistive load, 40 °C																		
220 V – 230 V	8	8	8	8	8	8	8	15	17	17	17	22	30	37	42	49	61	72	85
380 V – 400 V	13	13	13	14	14	14	14	26	29	29	29	39	53	65	72	85	105	125	150
400 V	15	15	15	16	16	16	16	30	34	34	34	45	58	71	80	94	116	138	170
500 V	18	18	18	19	19	19	19	34	38	38	38	51	66	81	90	107	132	156	194
660 V/690 V	23	23	23	25	25	25	25	45	51	51	51	68	91	111	125	148	182	216	268
1000 V	–	–	–	–	–	–	–	–	–	–	–	–	–	–	–	–	–	–	–
Conventional thermal Current	A	A	A	A	A	A	A	A	A	A	A	A	A	A	A	A	A	A	A
$I_{th} = I_e$ open at 40 °C	22	22	22	22	22	22	22	40	45	45	45	60	80	98	110	130	160	190	225

DILM, DILE(E)M, DILMP

Contactors

4 pole

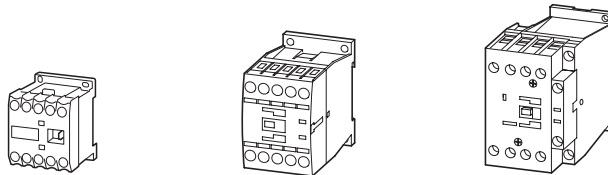

DIL	EM4	MP20	MP32
Rated operational voltage	→ 4	→ Page 34	→ Page 34
AC-1			
Conventional free air thermal current $I_{th} = I_e$ open, at 40 °C	A	A	A
up to 690 V	22	22	32

DILM, DILH, DILMP

Contactors
3 pole

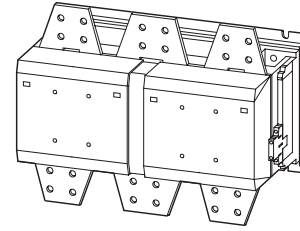
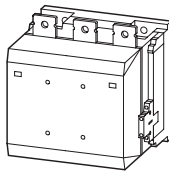
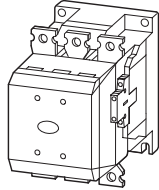
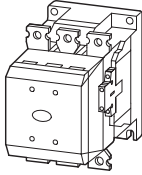
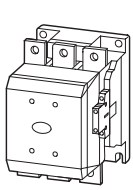

M185A	M225A	M250A	M300A	M400	M500	M580	M650	M750	M820	M1000	M1600	M1400	H2000	H2200	H2600
-	-	-	-	-	-	-	-	-	-	-	-	-	-	-	-
→ Page 30				→ Page 30			→ Page 30		→ Page 30		→ Page 32				
kW	kW	kW	kW	kW	kW	kW	kW	kW	kW	kW	kW	kW	kW	kW	kW

55	70	75	90	125	155	185	205	240	260	315	500	-	-	-	-
90	110	132	160	200	250	315	355	400	450	560	900	-	-	-	-
115	142	157	190	255	345	370	420	480	525	650	1000	-	-	-	-
132	160	180	215	290	360	420	470	550	600	730	1180	-	-	-	-
175	215	240	286	344	344	560	630	720	750	1000	1600	-	-	-	-
108	108	108	132	132	132	600	600	800	800	1000	1770	-	-	-	-

41	51	62	75	92	112	143	161	181	209	260	430	-	-	-	-
75	90	110	132	160	200	250	280	315	355	450	750	-	-	-	-
85	102	125	140	186	229	290	326	367	418	520	830	-	-	-	-
96	116	143	172	214	260	330	370	417	474	590	940	-	-	-	-
127	155	189	229	283	344	440	494	556	633	780	1300	-	-	-	-
108	108	108	132	132	132	509	509	678	678	1000	1650	-	-	-	-

121	139	155	177	221	310	354	376	398	443	443	717	620	886	1075	1269
210	241	268	306	382	535	612	650	689	766	766	1247	1071	1531	1870	2207
243	279	310	354	443	620	709	753	797	886	886	1371	1240	1773	2058	2427
277	317	352	403	503	705	806	856	906	1007	1007	1558	1410	2015	2338	2758
365	419	465	532	664	930	1064	1130	1196	1330	1330	2151	1861	2660	3227	3806
554	635	705	806	1007	1410	1612	1712	1813	2015	2015	2420	2417	3223	4676	5516

A	A	A	A	A	A	A	A	A	A	A	A	A	A	A	A
337	356	400	430	612	857	980	1041	1102	1225	1225	2200	1714	2450	2700	3185

DILM, DILE(E)M, DILMP

Contactors
4 pole

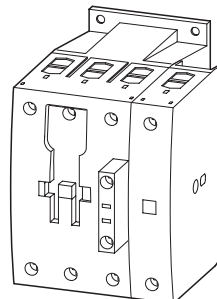
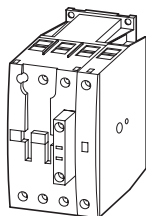

MP45	MP63	MP80	MP125	MP160	MP200
→ Page 34					
A	A	A	A	A	A
45	63	80	125	160	200

1.2 Contactors

1 System overview

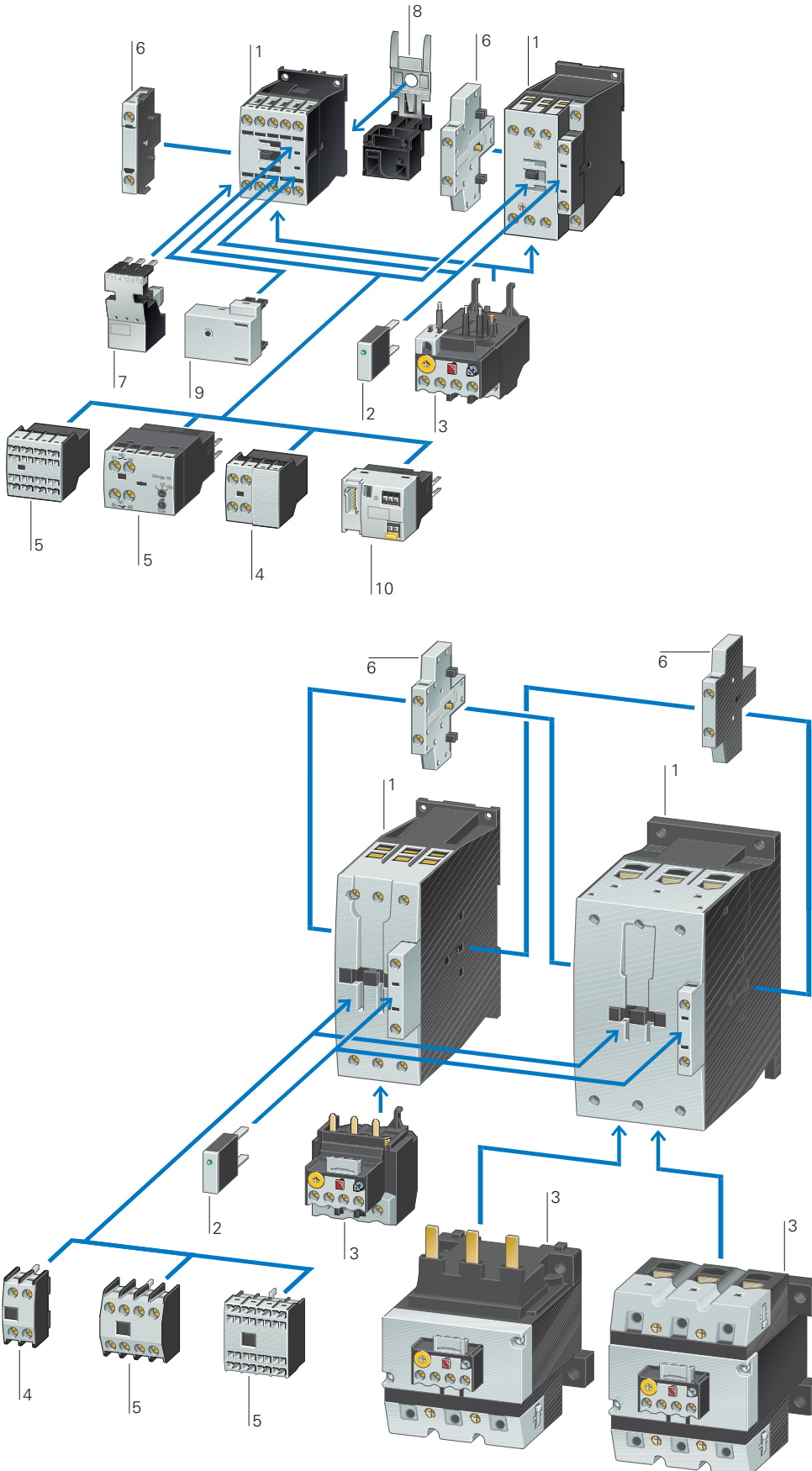

DILM7...DILM170

Contactors up to 90 kW (AC-3/400V) 1

- 3 pole
- Page 18
- 4 pole
- Page 34

Suppressor circuits 2

- Page 50

Overload relays 3

- Chapter 1.2 (Page 8)

Auxiliary contact modules 4

- Page 36

Auxiliary contact modules 5

- Page 36

Auxiliary contact modules 6

- Page 39

Motor feeder plug 7

- Page 58

PE module with contact plate 8

- Page 58

Motor suppressor module 9

- Page 59

SmartWire-DT® contactor module 10

- Page 58

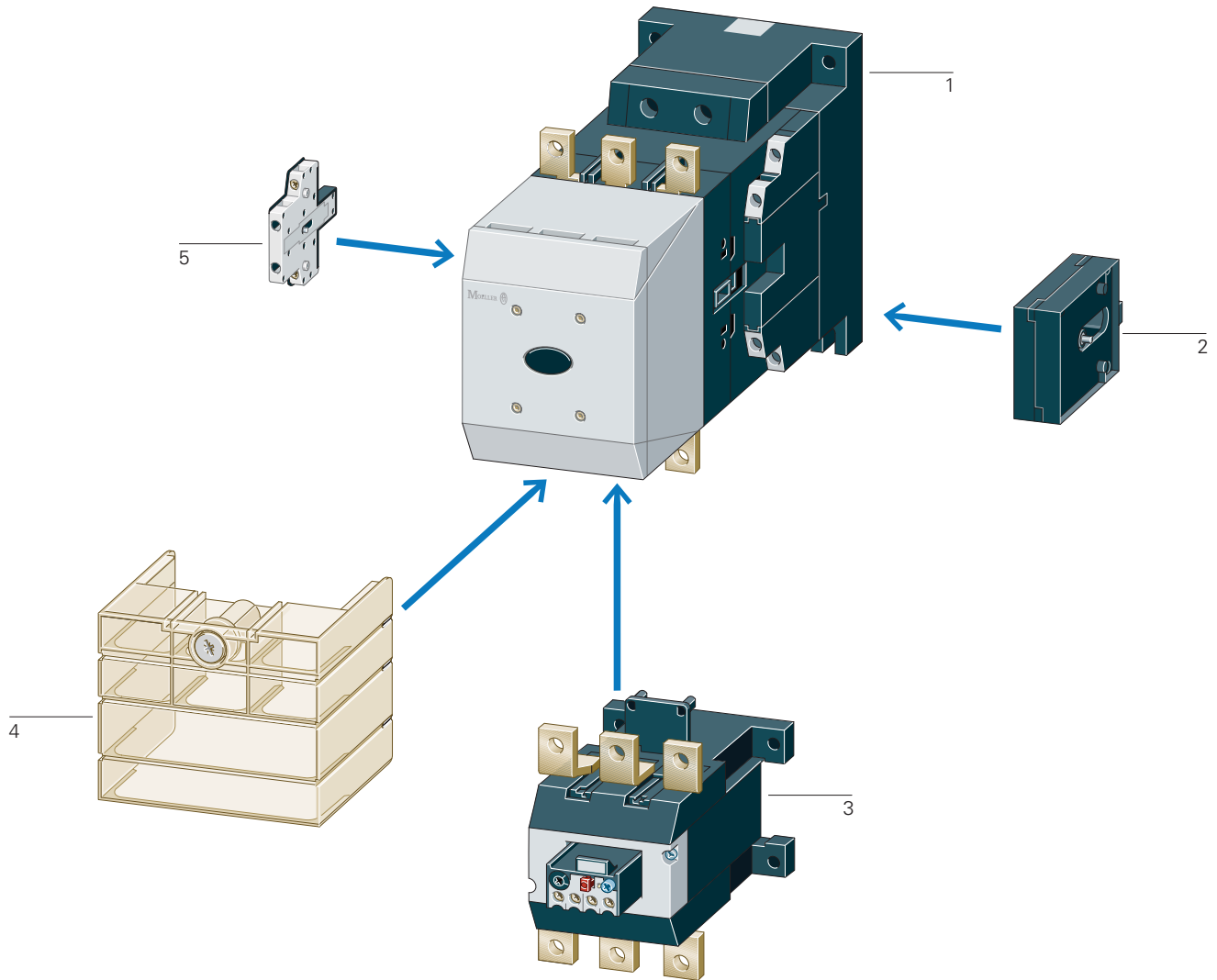

DILM185... DILH2600

Contactors 90 – 900 kW (AC-3/400 V) Comfort series	1
→ Page 30	
Standard range 90–250kW	1
→ Page 28	

Mechanical interlock	2
→ Page 52	
Overload relays	3
→ Chapter 1.2 (Page 12)	

Terminal shroud	4
→ Page 61	
Auxiliary contact modules	5
→ Page 39	

1.2

Contactors

Basic devices up to 170 A

1

DILM Basic device

Rated operational current

Max. motor rating for three-phase motors 50 - 60 Hz

Conventional thermal current $I_{th} = I_e$ AC-1 at 60 °C

Contact configuration

Circuit symbol

AC-3	AC-3		AC-4		Open	$I_{th} = I_e$ A	Contact configuration	Circuit symbol	
	380 V 400 V	220 V 230 V	380 V 400 V	660 V 690 V					220 V 230 V
7	2.2	3	3.5	1	2.2	2.9	20	1 N/O –	
7	2.2	3	3.5	1	2.2	2.9	20	– 1 NC	
9	2.5	4	4.5	1.5	2.5	3.6	20	1 N/O –	
9	2.5	4	4.5	1.5	2.5	3.6	20	– 1 NC	
12	3.5	5.5	6.5	2	3	4.4	20	1 N/O –	
12	3.5	5.5	6.5	2	3	4.4	20	– 1 NC	
15.5	4	7.5	7	2	3	4.4	20	1 N/O –	
15.5	4	7.5	7	2	3	4.4	20	– 1 NC	
18	5	7.5	11	2.5	4.5	6.5	35	1 N/O –	
18	5	7.5	11	2.5	4.5	6.5	35	– 1 NC	
25	7.5	11	14	3.5	6	8.5	40	1 N/O –	
25	7.5	11	14	3.5	6	8.5	40	– 1 NC	
32	10	15	17	4	7	10	40	1 N/O –	
32	10	15	17	4	7	10	40	– 1 NC	
38	11	18.5	21	4	7	10	40	1 N/O –	
38	11	18.5	21	4	7	10	40	– 1 NC	

Screw terminals
3 pole

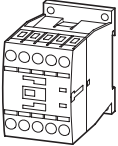

Screw terminals
3 pole

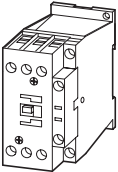

Information relevant for export to North America



Product Standards	IEC/EN 60947-4-1; UL 508; CSA-C22.2 No.14-05; CE marking
UL File No.	E29096
UL CCN	NLDX
CSA File No.	012528
CSA Class No.	2411-03, 3211-04
NA Certification	UL Listed, CSA certified
See also	→ Page 80

Can be combined with auxiliary contact	AC operation	DC operation			
	Part no. Article no.	Price See price list	Part no. Article no.	Price See price list	Std. pack
					Notes

DILM32-XHI.. DILA-XHI(V)..	DILM7-10(230V50Hz) 276550	DILM7-10(24VDC) 276565	1 off 
DILA-XHI(V)..	DILM7-01(230V50Hz) 276585	DILM7-01(24VDC) 276600	
DILM32-XHI.. DILA-XHI(V)..	DILM9-10(230V50Hz) 276690	DILM9-10(24VDC) 276705	
DILA-XHI(V)..	DILM9-01(230V50Hz) 276725	DILM9-01(24VDC) 276740	
DILM32-XHI.. DILA-XHI(V)..	DILM12-10(230V50Hz) 276830	DILM12-10(24VDC) 276845	
DILA-XHI(V)..	DILM12-01(230V50Hz) 276865	DILM12-01(24VDC) 276880	
DILM32-XHI.. DILA-XHI(V)..	DILM15-10(230V50Hz)¹⁾ 290058	DILM15-10(24VDC)¹⁾ 290073	
DILA-XHI(V)..	DILM15-01(230V50Hz)¹⁾ 290093	DILM15-01(24VDC)¹⁾ 290108	
DILM32-XHI.. DILA-XHI(V).. DILM32-XHI11-S	DILM17-10(230V50Hz) 277004	DILM17-10(RDC24) 277018	
DILA-XHI(V).. DILM32-XHI11-S	DILM17-01(230V50Hz) 277036	DILM17-01(RDC24) 277050	
DILM32-XHI.. DILA-XHI(V).. DILM32-XHI11-S	DILM25-10(230V50Hz) 277132	DILM25-10(RDC24) 277146	
DILA-XHI(V).. DILM32-XHI11-S	DILM25-01(230V50Hz) 277164	DILM25-01(RDC24) 277178	
DILM32-XHI.. DILA-XHI(V).. DILM32-XHI11-S	DILM32-10(230V50Hz) 277260	DILM32-10(RDC24) 277274	
DILA-XHI(V).. DILM32-XHI11-S	DILM32-01(230V50Hz) 277292	DILM32-01(RDC24) 277306	
DILM32-XHI.. DILA-XHI(V).. DILM32-XHI11-S	DILM38-10(230V50Hz)¹⁾ 112428	DILM38-10(RDC24)¹⁾ 112442	
DILA-XHI(V).. DILM32-XHI11-S	DILM38-01(230V50Hz)¹⁾ 112456	DILM38-01(RDC24)¹⁾ 112470	

Contacts to EN 50 012.
For all DC operated contactors DILM7 - DILM15 the following applies:
 • Integrated varistor-suppressor circuit.
 For DC operated contactors DILM17 - DILM170 the following applies:
 • Integrated suppressor circuit in actuating electronics
 For AC operated contactors DILM115 - DILM170 the following applies:
 • Integrated suppressor circuit in actuating electronics
 For DILM7-01 – DILM38-01 the following applies:
 • With mirror contact.

¹⁾ Electrical lifespan → 87

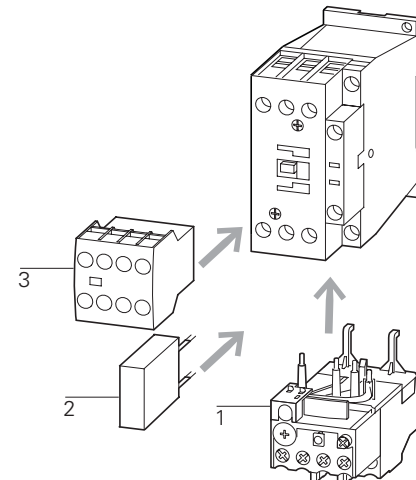

Accessories	Page
1 Overload relay	→ Chapter 1.2
2 Suppressor	→ 50
3 Auxiliary contact module	→ 36
Further actuating voltages	→ 69
Accessories	→ 52

1.2

Contactors

Basic devices up to 170 A

1

DILM Basic device

Rated operational current

Max. motor rating for three-phase motors 50 - 60 Hz

Conventional thermal current $I_{th} = I_e$ AC-1 at 60 °C

Contact configuration

Circuit symbol

AC-3	AC-3		AC-4		AC-4		
380 V	220 V	380 V	660 V	220 V	380 V	660 V	Open
400 V	230 V	400 V	690 V	230 V	400 V	690 V	

N/O = normally open contact
NC = normally closed contact

Screw terminals
3 pole

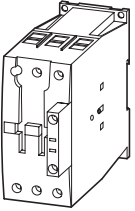

Screw terminals
3 pole

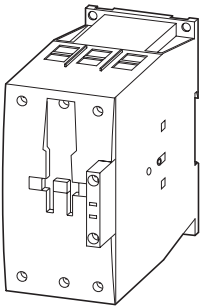

I_e A	P kW	P kW	P kW	P kW	P kW	P kW	$I_{th} = I_e$ A			
40	12.5	18.5	23	5	9	12	50	—	—	
50	15.5	22	30	6	10	14	65	—	—	
65	20	30	35	7	12	17	80	—	—	
72	25	37	35	7	12	17	80	—	—	
80	25	37	63	12	20	26	90	—	—	
95	30	45	75	16	26	35	110	—	—	
115	37	55	90	17	28	43	130	—	—	
150	48	75	96	20	33	48	160	—	—	
170	52	90	140	20	33	48	185	—	—	

Information relevant for export to North America



Product Standards	IEC/EN 60947-4-1; UL 508; CSA-C22.2 No.14-05; CE marking
UL File No.	E29096
UL CCN	NLDX
CSA File No.	012528
CSA Class No.	2411-03, 3211-04
NA Certification	UL Listed, CSA certified
See also	→ Page 80

	AC operation		DC operation			
Can be combined with auxiliary contact	Part no. Article no.	Price See price list	Part no. Article no.	Price See price list	Std. pack	Notes

DILM150-XHI(V).. DILM1000-XHI(V)..	DILM40(230V50Hz) 277766		DILM40(RDC24) 277780			
DILM150-XHI(V).. DILM1000-XHI(V)..	DILM50(230V50Hz) 277830		DILM50(RDC24) 277844			
DILM150-XHI(V).. DILM1000-XHI(V)..	DILM65(230V50Hz) 277894		DILM65(RDC24) 277908			
DILM150-XHI(V).. DILM1000-XHI(V)..	DILM72(230V50Hz)¹⁾ 107670		DILM72(RDC24)¹⁾ 107671			
DILM150-XHI(V).. DILM1000-XHI(V)..	DILM80(230V50Hz) 239402		DILM80(RDC24) 239416			
DILM150-XHI(V).. DILM1000-XHI(V)..	DILM95(230V50Hz) 239480		DILM95(RDC24) 239510			
DILM150-XHI(V).. DILM1000-XHI(V)..	DILM115(RAC240) 239548		DILM115(RDC24) 239555			
DILM150-XHI(V).. DILM1000-XHI(V)..	DILM150(RAC240) 239588		DILM150(RDC24) 239591			
DILM150-XHI(V).. DILM1000-XHI(V)..	DILM170(RAC240)¹⁾ 107013		DILM170(RDC24)¹⁾ 107016			

1 off 

Contacts to EN 50012.

For all DC operated contactors DILM7 - DILM15 the following applies:

- Integrated varistor-suppressor circuit.

For DC operated contactors DILM17 - DILM170 the following applies:

- Integrated suppressor circuit in actuating electronics

For AC operated contactors DILM115 - DILM170 the following applies:

- Integrated suppressor circuit in actuating electronics

For DILM7-01 – DILM38-01 the following applies:

- With mirror contact.

¹⁾ Electrical lifespan → 87

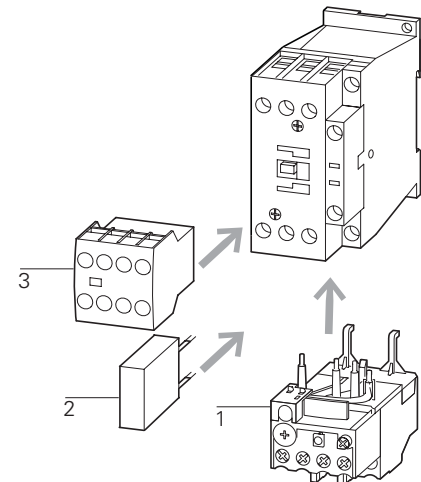

Accessories

- 1 Overload relay
- 2 Suppressor
- 3 Auxiliary contact module
- Further actuating voltages
- Accessories

Page

- Chapter 1.2
- 50
- 36
- 71
- 52

1.2

Contactors

Basic devices up to 170 A

1

DILM Basic device

Rated operational current	Max. motor rating for three-phase motors 50 - 60 Hz						Conventional thermal current $I_{th} = I_e$ AC-1 at 60 °C	Contact configuration	Circuit symbol	
	AC-3		AC-3		AC-4					
380 V 400 V	220 V	380 V	660 V	220 V	380 V	660 V	Open	N/O = normally open contact NC = normally closed contact		
I_e A	P	P	P	P	P	P				
	kW	kW	kW	kW	kW	kW	$I_{th} = I_e$ A			
7	2.2	3	3.5	1	2.2	2.9	20	1 N/O	–	
7	2.2	3	3.5	1	2.2	2.9	20	–	1 NC	
9	2.5	4	4.5	1.5	2.5	3.6	20	1 N/O	–	
9	2.5	4	4.5	1.5	2.5	3.6	20	–	1 NC	
12	3.5	5.5	6.5	2	3	4.4	20	1 N/O	–	
12	3.5	5.5	6.5	2	3	4.4	20	–	1 NC	
15.5	4	7.5	7	2	3	4.4	20	1 N/O	–	
15.5	4	7.5	7	2	3	4.4	20	–	1 NC	
18	5	7.5	11	2.5	4.5	6.5	35	1 N/O	–	
18	5	7.5	11	2.5	4.5	6.5	35	–	1 NC	
25	7.5	11	14	3.5	6	8.5	40	1 N/O	–	
25	7.5	11	14	3.5	6	8.5	40	–	1 NC	
32	10	15			7	10	40	1 N/O	–	
32	10	15			7	10	40	–	1 NC	
40	12.5	18.5			9	12	50	–	–	
50	15.5	22			10	14	65	–	–	
65	20	30			12	17	80	–	–	
80	25	37	63	12	20	26	90	–	–	
95	30	45	75	16	26	35	110	–	–	
115	37	55	90	17	28	43	130	–	–	
150	48	75	96	20	33	48	160	–	–	

Spring-loaded terminals
3 pole

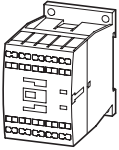

Spring-loaded terminals on auxiliary and control circuit terminals
3 pole

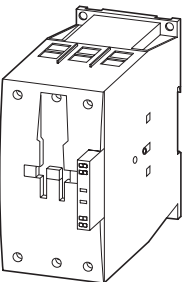
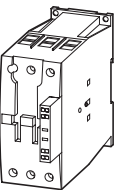
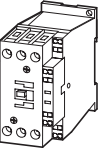

Information relevant for export to North America



Product Standards	IEC/EN 60947-4-1; UL 508; CSA-C22.2 No.14-05; CE marking
UL File No.	E29096
UL CCN	NLDX
CSA File No.	012528
CSA Class No.	2411-03, 3211-04
NA Certification	UL Listed, CSA certified
See also	→ Page 80

Can be combined with auxiliary contact

	AC operation	DC operation	Std. pack	Notes
	Part no. Article no.	Part no. Article no.		
	Price See price list	Price See price list		
DILM32-XHIC.. DILA-XHIC(V)..	DILMC7-10(230V50Hz) 277389	DILMC7-10(24VDC) 277404	1 off 	<p>Contacts to EN 50 012.</p> <p>For DILMC7 – DILMC15 the following applies:</p> <ul style="list-style-type: none"> • Auxiliary coil, and main current terminals with spring-loaded terminals. <p>For DILMC17 – DILMC150 the following applies:</p> <ul style="list-style-type: none"> • Auxiliary connections, coil connections with spring-loaded connection terminals. • Main current connections with screw terminals. <p>For DC operated contactors DILMC7 - DILMC15 the following applies:</p> <ul style="list-style-type: none"> • Integrated varistor-suppressor circuit. <p>For DC operated contactors DILMC17 - DILMC150 the following applies:</p> <ul style="list-style-type: none"> • Integrated suppressor circuit in actuating electronics <p>For AC operated contactors DILMC115 - DILMC150 the following applies:</p> <ul style="list-style-type: none"> • Integrated suppressor circuit in actuating electronics <p>For DILMC7-01 – DILMC32-01 the following applies:</p> <ul style="list-style-type: none"> • With mirror contact.
DILA-XHIC(V)..	DILMC7-01(230V50Hz) 277421	DILMC7-01(24VDC) 277436		
DILM32-XHIC.. DILA-XHIC(V)..	DILMC9-10(230V50Hz) 277453	DILMC9-10(24VDC) 277468		
DILA-XHIC(V)..	DILMC9-01(230V50Hz) 277485	DILMC9-01(24VDC) 277500		
DILM32-XHIC.. DILA-XHIC(V)..	DILMC12-10(230V50Hz) 277517	DILMC12-10(24VDC) 277532		
DILA-XHIC(V)..	DILMC12-01(230V50Hz) 277549	DILMC12-01(24VDC) 277564		
DILM32-XHIC... DILA-XHIC(V)...	DILMC15-10(230V50Hz) 293911	DILMC15-10(24VDC) 293926		
DILA-XHIC(V)...	DILMC15-01(230V50Hz) 293946	DILMC15-01(24VDC) 293961		
DILM32-XHIC.. DILA-XHIC(V)..	DILMC17-10(230V50Hz) 277581	DILMC17-10(RDC24) 277595		
DILA-XHIC(V)..	DILMC17-01(230V50Hz) 277611	DILMC17-01(RDC24) 277625		
DILM32-XHIC.. DILA-XHIC(V)..	DILMC25-10(230V50Hz) 277641	DILMC25-10(RDC24) 277655		
DILA-XHIC(V)..	DILMC25-01(230V50Hz) 277671	DILMC25-01(RDC24) 277685		
DILM32-XHIC.. DILA-XHIC(V)..	DILMC32-10(230V50Hz) 277701	DILMC32-10(RDC24) 277715		
DILA-XHIC(V)..	DILMC32-01(230V50Hz) 277731	DILMC32-01(RDC24) 277745		
DILM150- XHIC(V)..	DILMC40(230V50Hz) 277965	DILMC40(RDC24) 277979		
DILM1000-XHIC..	DILMC50(230V50Hz) 277995	DILMC50(RDC24) 278009		
	DILMC65(230V50Hz) 278025	DILMC65(RDC24) 278039		
	DILMC80(230V50Hz) 239618	DILMC80(RDC24) 239652		
	DILMC95(230V50Hz) 239685	DILMC95(RDC24) 239715		
	DILMC115(RAC240) 239736	DILMC115(RDC24) 239741		
	DILMC150(RAC240) 239751	DILMC150(RDC24) 239765		

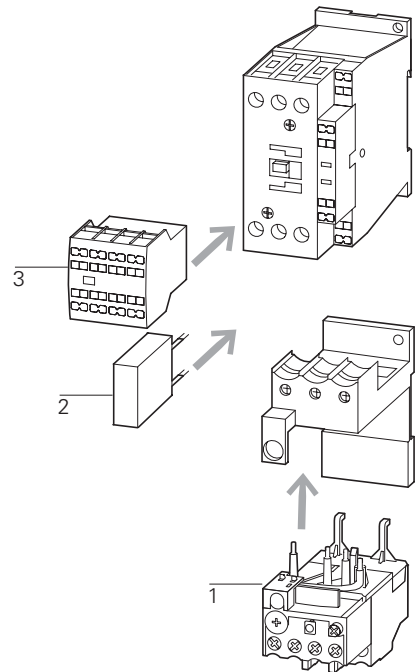

Accessories	Page
1 Overload relay	→ Chapter 1.2
2 Suppressor	→ 50
3 Auxiliary contact module	→ 36
Further actuating voltages	→ 73
Accessories	→ 52

1.2

Contactors

Complete device up to 170 A

1

DILM complete device

Rated operational current AC-3	Max. motor rating for three-phase motors 50 - 60 Hz						Conventional free air thermal current $I_{th} = I_e$ AC-1 at 60 °C	Contact configuration: ⊕ = Safety function by positive opening according to IEC/EN 60947-5-1	Circuit symbol	
	AC-3			AC-4						
380 V 400 V	220 V 230 V	380 V 400 V	660 V 690 V	220 V 230 V	380 V 400 V	660 V 690 V	Open $I_{th} = I_e$	N/O = normally open contact NC = normally closed contact		
I_e	P	P	P	P	P	P	A			
A	kW	kW	kW	kW	kW	kW				
7	2.2	3	3.5	1	2.2	2.9	20	2 N/O	1 NC	
7	2.2	3	3.5	1	2.2	2.9	20	2 N/O	1 NC	
7	2.2	3	3.5	1	2.2	2.9	20	3 N/O	2 NC	
9	2.5	4	4.5	1.5	2.5	3.6	20	2 N/O	1 NC	
9	2.5	4	4.5	1.5	2.5	3.6	20	2 N/O	1 NC	
9	2.5	4	4.5	1.5	2.5	3.6	20	3 N/O	2 NC	
12	3.5	5.5	6.5	2	3	4.4	20	2 N/O	1 NC	
12	3.5	5.5	6.5	2	3	4.4	20	2 N/O	1 NC	
12	3.5	5.5	6.5	2	3	4.4	20	3 N/O	2 NC	
15.5	4	7.5	7	2	3	4.4	20	2 N/O	2 NC	
18	5	7.5	11	2.5	4.5	6.5	35	2 N/O	1 NC	
18	5	7.5	11	2.5	4.5	6.5	35	2 N/O	1 NC	
18	5	7.5	11	2.5	4.5	6.5	35	3 N/O	2 NC	
25	7.5	11	14	3.5	6	8.5	40	2 N/O	1 NC	
25	7.5	11	14	3.5	6	8.5	40	2 N/O	1 NC	
25	7.5	11	14	3.5	6	8.5	40	3 N/O	2 NC	
32	10	15	17	4	7	10	40	2 N/O	1 NC	
32	10	15	17	4	7	10	40	2 N/O	1 NC	
32	10	15	17	4	7	10	40	3 N/O	2 NC	

Screw terminals

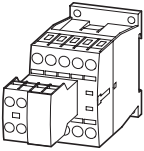

Screw terminals

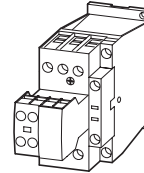

Information relevant for export to North America



Product Standards	IEC/EN 60947-4-1; UL 508; CSA-C22.2 No.14-05; CE marking
UL File No.	E29096
UL CCN	NLDX
CSA File No.	012528
CSA Class No.	2411-03, 3211-04
NA Certification	UL Listed, CSA certified
See also	→ Page 80

AC operation		DC operation		Std. pack	Notes
Part no. Article no.	Price See price list	Part no. Article no.	Price See price list		

DILM7-21(230V50Hz) 276620	DILM7-21(24VDC) 276635
DILM7-22(230V50Hz) 106360	DILM7-22(24VDC) 106367
DILM7-32(230V50Hz) 276655	DILM7-32(24VDC) 276670
DILM9-21(230V50Hz) 276760	DILM9-21(24VDC) 276775
DILM9-22(230V50Hz) 106361	DILM9-22(24VDC) 106368
DILM9-32(230V50Hz) 276795	DILM9-32(24VDC) 276810
DILM12-21(230V50Hz) 276900	DILM12-21(24VDC) 276915
DILM12-22(230V50Hz) 106362	DILM12-22(24VDC) 106369
DILM12-32(230V50Hz) 276935	DILM12-32(24VDC) 276950
DILM15-22(230V50Hz) 106363	DILM15-22(24VDC) 106370
DILM17-21(230V50Hz) 277068	DILM17-21(RDC24) 277082
DILM17-22(230V50Hz) 106364	DILM17-22(RDC24) 106371
DILM17-32(230V50Hz) 277100	DILM17-32(RDC24) 277114
DILM25-21(230V50Hz) 277196	DILM25-21(RDC24) 277210
DILM25-22(230V50Hz) 106365	DILM25-22(RDC24) 106372
DILM25-32(230V50Hz) 277228	DILM25-32(RDC24) 277242
DILM32-21(230V50Hz) 277324	DILM32-21(RDC24) 277338
DILM32-22(230V50Hz) 106366	DILM32-22(RDC24) 106373
DILM32-32(230V50Hz) 277356	DILM32-32(RDC24) 277370

1 off

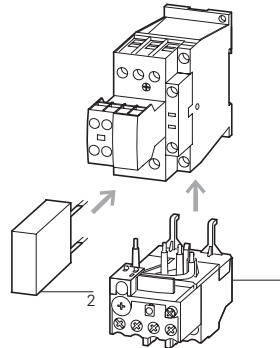
Accessories

- 1 Overload relay
- 2 Suppressor
- Accessories

Page

- Chapter 1.2
- 50
- 52

For all DC operated contactors DILM7 - DILM15 the following applies:

- Integrated varistor suppressor circuit.

For DC operated contactors DILM17 - DILM170 the following applies:

- Integrated suppressor circuit in actuating electronics

For AC operated contactors DILM115 - DILM170 the following applies:

- Integrated suppressor circuit in actuating electronics

For DILM7 - DILM150 the following applies:

- With mirror contact.

Contacts to EN 50012

1.2

Contactors

Complete device up to 170 A

1

DILM complete device

Rated operational current AC-3	Max. motor rating for three-phase motors 50 - 60 Hz						Conventional free air thermal current $I_{th} = I_e$ AC-1 at 60 °C	Contact configuration: ☉ = Safety function by positive opening according to IEC/EN 60947-5-1	Circuit symbol	
	AC-3		AC-4							
380 V 400 V	220 V	380 V 400 V	660 V	220 V	380 V 400 V	660 V	Open $I_{th} = I_e$	N/O = normally open contact	NC = normally closed contact	
I_e	P	P	P	P	P	P	A			
A	kW	kW	kW	kW	kW	kW				
40	12.5	18.5	23	5	9	12	50	2 N/O	2 NC	
50	15.5	22	30	6	10	14	65	2 N/O	2 NC	
65	20	30	35	7	12	17	80	2 N/O	2 NC	
80	25	37	63	12	20	26	90	2 N/O	2 NC	
95	30	45	75	16	26	35	110	2 N/O	2 NC	
115	37	55	90	17	28	43	130	2 N/O	2 NC	
150	48	75	96	20	34	48	160	2 N/O	2 NC	

Screw terminals

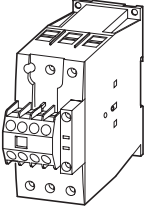

Screw terminals

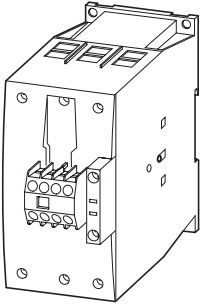

Information relevant for export to North America

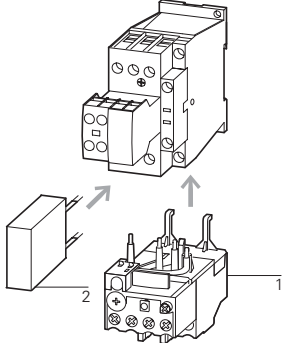

Product Standards	IEC/EN 60947-4-1; UL 508; CSA-C22.2 No.14-05; CE marking
UL File No.	E29096
UL CCN	NLDX
CSA File No.	012528
CSA Class No.	2411-03, 3211-04
NA Certification	UL Listed, CSA certified
See also	→ Page 80

AC operation		DC operation		Std. pack	Notes
Part no. Article no.	Price See price list	Part no. Article no.	Price See price list		
DILM40-22(230V50Hz) 277798		DILM40-22(RDC24) 277812		1 off 	 <p>Accessories</p> <p>1 Overload relay → Chapter 1.2</p> <p>2 Suppressor → 50</p> <p>Accessories → 52</p> <p>For DC operated contactors DILM17 - DILM170 the following applies:</p> <ul style="list-style-type: none"> • Integrated suppressor circuit in actuating electronics <p>For AC operated contactors DILM115 - DILM170 the following applies:</p> <ul style="list-style-type: none"> • Integrated suppressor circuit in actuating electronics <p>For DILM7 - DILM150 the following applies:</p> <ul style="list-style-type: none"> • With mirror contact. <p>Contacts to EN 50012</p>
DILM50-22(230V50Hz) 277862		DILM50-22(RDC24) 277876			
DILM65-22(230V50Hz) 277926		DILM65-22(RDC24) 277940			
DILM80-22(230V50Hz) 239449		DILM80-22(RDC24) 239463			
DILM95-22(230V50Hz) 239527		DILM95-22(RDC24) 239541			
DILM115-22(RAC240) 239578		DILM115-22(RDC24) 239581			
DILM150-22(RAC240) 239598		DILM150-22(RDC24) 239601			

Accessories	Page
1 Overload relay	→ Chapter 1.2
2 Suppressor	→ 50
Accessories	→ 52

For DC operated contactors DILM17 - DILM170 the following applies:

- Integrated suppressor circuit in actuating electronics

For AC operated contactors DILM115 - DILM170 the following applies:

- Integrated suppressor circuit in actuating electronics

For DILM7 - DILM150 the following applies:

- With mirror contact.

Contacts to EN 50012

1.2

Contactors DILM, DILH

Standard devices greater than 150 A

1

DILM...S/22... Standard device for currents greater than 150 A

Rated operational current	Max. motor rating for three-phase motors 50 - 60 Hz						Conventional thermal current $I_{th} = I_e$ AC-1 at 40 °C Open $I_{th} = I_e$	Circuit symbol	For use with
	AC-3		AC-3		AC-4				
380 V	220 V	380 V	660 V	220 V	380 V	660 V		DILM820-XHI...	
400 V	230 V	400 V	690 V	230 V	400 V	690 V			
I_e	P	P	P	P	P	P			
A	kW	kW	kW	kW	kW	kW			
250	75	132	240	62	110	189			
300	90	160	195	75	132	160			
400	125	200	344	92	160	283		DILM820-XHI...	
500	155	250	344	112	200	344			
580	185	315	344	112	200	344			

DILM complete device

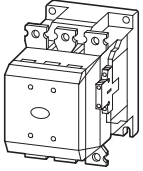

DILM complete device

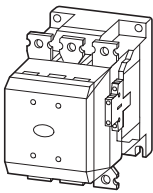

Notes

¹⁾ Availability from August 2010.
Previous DILM300/22, see Online Catalog at <http://www.eaton.com.cn/electrical>

For all contactors the following applies:

- 660 V, 690 V or 1000 V: do not reverse directly
- Integrated suppressor circuit in actuating electronics.

DILM...S contactors are actuated conventionally

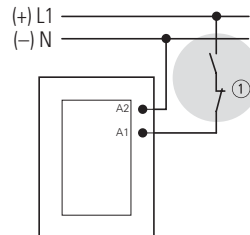











① Stopping in the event of an emergency (emergency switching off)

Accessories

- Auxiliary contact modules
- Enclosures totally insulated
- Further actuating voltages

Page

- 38
- 77

Part no. Article no.	Price See price list	Std. pack	Information relevant for export to North America	
DILM250-S/22(220-240V50/60Hz) 274190	1 off	 	Product Standards UL File No. UL CCN CSA File No. CSA Class No. NA Certification	IEC/EN 60947-4-1; UL 508; CSA-C22.2 No.14-05; CE marking E29096 NLDX 1017510 3211-04 UL Listed, CSA certified
DILM300A-S/22(220-240V50/60Hz)¹⁾ 139559	1 off	 	Request filed for UL and CSA	
DILM400-S/22(220-240V50/60Hz) 274196	1 off	 	Product Standards UL File No. UL CCN CSA File No. CSA Class No. NA Certification See also	IEC/EN 60947-4-1; UL 508; CSA-C22.2 No.14-05; CE marking E29096 NLDX 012528 3211-04 UL Listed, CSA certified Additional approvals, → Page 82
DILM500-S/22(220-240V50/60Hz) 274199	1 off	 		
DILM570-S/22(220-240V50/60Hz) 110744	1 off	 		

1.2

Contactors DILM, DILH

Comfort devices greater than 150 A

1

DILM, DILH

Rated operational current

Max. motor rating for three-phase motors 50 - 60 Hz

Conventional thermal current $I_{th} = I_e$
AC-1 at 60 °C

Circuit symbol

AC-3 380 V 400 V	AC-3			AC-4			Open $I_{th} = I_e$		
	220 V 230 V	380 V 400 V	660 V 690 V	1000 V	220 V 230 V	380 V 400 V		660 V 690 V	1000 V
I_e A	P kW	P kW	P kW	P kW	P kW	P kW	P kW	P kW	A

185	55	90	140	108	41	75	102	77	275
------------	----	-----------	-----	-----	----	-----------	-----	----	-----

225	70	110	150	108	51	90	110	77	315
------------	----	------------	-----	-----	----	-----------	-----	----	-----

250	75	132	195	108	62	110	160	109	330
------------	----	------------	-----	-----	----	------------	-----	-----	-----

300	90	160	195	132	75	132	160	109	350
------------	----	------------	-----	-----	----	------------	-----	-----	-----

400	125	200	344	132	92	160	283	132	500
------------	-----	------------	-----	-----	----	------------	-----	-----	-----

500	155	250	344	132	112	200	344	132	700
------------	-----	------------	-----	-----	-----	------------	-----	-----	-----

580	185	315	560	600	143	250	440	509	800
------------	-----	------------	-----	-----	-----	------------	-----	-----	-----

650	205	355	630	600	161	280	494	509	850
------------	-----	------------	-----	-----	-----	------------	-----	-----	-----

750	240	400	720	800	181	315	556	678	900
------------	-----	------------	-----	-----	-----	------------	-----	-----	-----

820	260	450	750	800	209	355	633	678	1000
------------	-----	------------	-----	-----	-----	------------	-----	-----	------

1000	315	560	1000	1100	260	450	780	1000	1000
-------------	-----	------------	------	------	-----	------------	-----	------	------

1600	500	900	1600	1770	430	750	1300	1650	1800
-------------	-----	------------	------	------	-----	------------	------	------	------

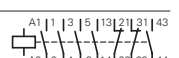
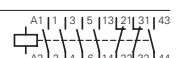
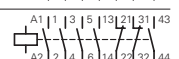
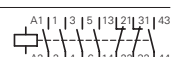

Contactors, comfort DILM

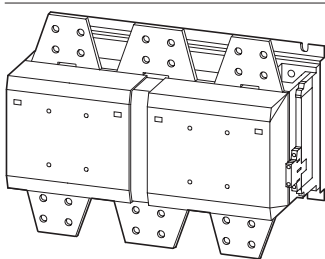
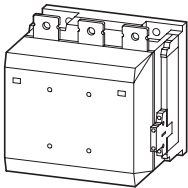
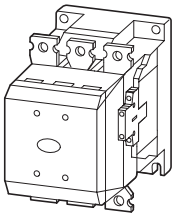
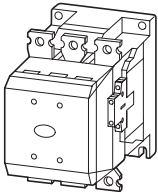
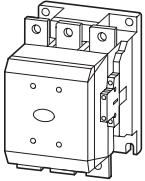

Notes

¹⁾ Availability from August 2010.
Previous DILM185/22 to DILM300/22, see Online Catalog at <http://www.eaton.com.cn/electrical>

For all contactors the following applies:

- 660 V, 690 V or 1000 V: do not reverse directly
- Integrated suppressor circuit in actuating electronics.

When operating contactors DILM580 to DILM1600 behind a frequency inverter or mains with strong harmonic loads, the suppressor circuit on the load side must be removed.

During high-voltage tests, the suppressor circuit on the load-side for DILM580 to DILH2600 contactors must be disconnected (see instructional leaflet).

Control voltages

RA250 $\hat{=}$ 110 V - 250 V AC/DC

RAW250 $\hat{=}$ 230 V - 250 V AC/DC

Accessories

Auxiliary contact modules

Page

→ 38

Suppressor circuits on load side

→ 61

Enclosures

totally insulated

Further actuating voltages

→ 72

Part no.
Article no.

Price
See price list

Std. pack

Notes

DILM185A/22(RAC240)¹⁾
139537

1 off

Conventional
A1/A2 are attached to power supply as normal

DILM 185 A, DILM 225 A

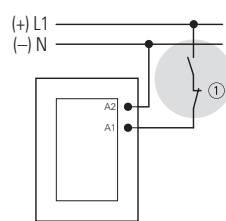

DILM250 to DILM1000, DILH1400

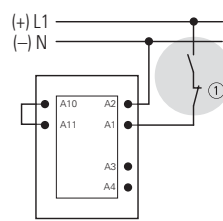

DILM1600 to DILH 2600

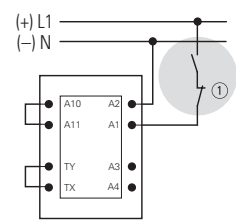

DILM250/22(RA250)²⁾
208201

DILM300A/22(RA250)^{1) 2)}
139556

Directly from the PLC
A 24 V output from the PLC can be directly connected to the terminals A4/A24.

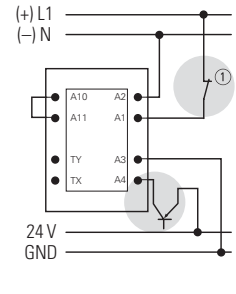
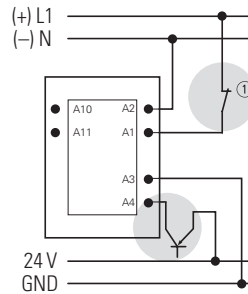
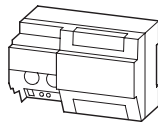

DILM400/22(RA250)³⁾
208209

DILM500/22(RA250)³⁾
208213

From a low-power command device

Low-power actuating devices such as PCB relays, pilot devices or position switches can be directly connected to A10/A11.

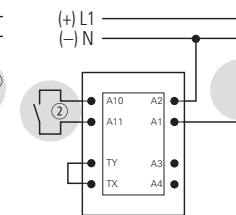
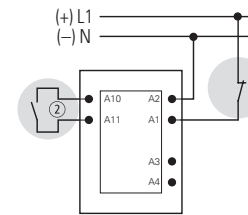

DILM580/22(RA250)³⁾
208216

DILM650/22(RA250)³⁾
208219

DILM750/22(RA250)³⁾
208222

DILM820/22(RA250)³⁾
208225

DILM1000/22(RA250)³⁾
267214

DILM1600/22(RAW250)³⁾
106727

- ① Stopping in the event of an emergency (emergency switching off)
- ② Max. cable capacitance 6 nF

Information relevant for export to North America



- 1)
NA Certification Request filed for UL and CSA
- 2)
Product Standards IEC/EN 60947-4-1; UL 508; CSA-C22.2 No.14-05; CE marking
UL File No. E29096
UL CCN NLDX
CSA File No. 1017510
CSA Class No. 3211-04
NA Certification UL Listed, CSA certified
- 3)
Product Standards IEC/EN 60947-4-1; UL 508; CSA-C22.2 No.14-05; CE marking
UL File No. E29096
UL CCN NLDX
CSA File No. 012528
CSA Class No. 3211-04
NA Certification UL Listed, CSA certified
See also Additional approvals, → Page 82

1.2 Contactors DILM, DILH

Comfort devices greater than 150 A

1

DILM, DILH

Conventional thermal current $I_{th} = I_e$
 AC-1 at 60 °C
 Open
 $I_{th} = I_e$
 A

Circuit symbol

Part no.
Article no.

Price
See price list

Std. pack

DILH comfort devices AC-1

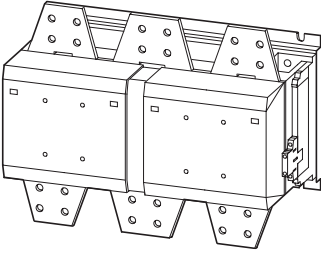

1400		DILH1400/22(RAW250)¹⁾ 272441	1 off
2000		DILH2000/22(RAW250)¹⁾ 272442	1 off
2200		DILH2200/22(RAW250)¹⁾ 111793	1 off
2600		DILH2600/22(RAW250)²⁾ 125945	1 off

Notes

For all contactors the following applies:

- 660 V, 690 V or 1000 V: do not reverse directly
- Integrated suppressor circuit in actuating electronics.

When operating contactors DILM580 to DILM1600 behind a frequency inverter or mains with strong harmonic loads, the suppressor circuit on the load side must be removed.

During high-voltage tests, the suppressor circuit on the load-side for DILM580 to DILH2600 contactors must be disconnected (see instructional leaflet).

Control voltages

RAW250 \triangleq 230 V - 250 V AC/DC

Accessories

Auxiliary contact modules

Page

→ 38

Suppressor circuits on load side

→ 61

Enclosures

totally insulated

Notes

Conventional

A1/A2 are attached to power supply as normal

DILH1400

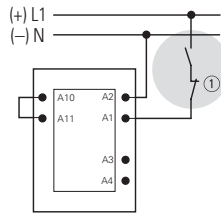

DILM1600 to DILH 2600

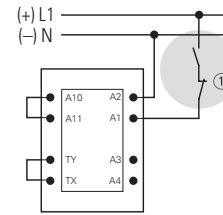

Directly from the PLC

A 24 V output from the PLC can be directly connected to the terminals A4/A24.

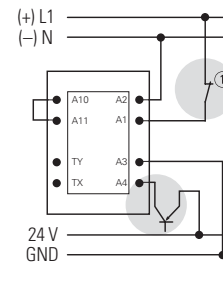
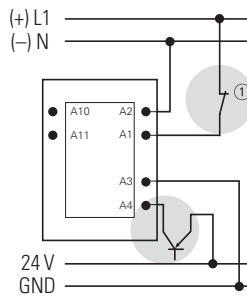
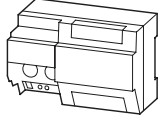

From a low-power command device

Low-power actuating devices such as PCB relays, pilot devices or position switches can be directly connected to A10/A11.

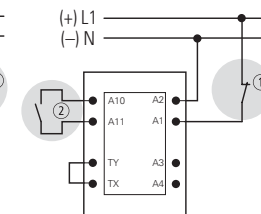
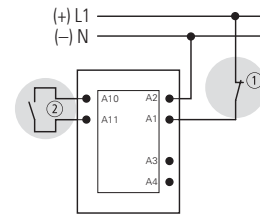

- ① Stopping in case of emergency (Emergency-stop)
- ② Max. cable capacitance 6 nF

Information relevant for export to North America



1)	
Product Standards	IEC/EN 60947-4-1; UL 508; CSA-C22.2 No.14-05; CE marking
UL File No.	E29096
UL CCN	NLDX
CSA File No.	012528
CSA Class No.	3211-04
NA Certification	UL Listed, CSA certified

2)	
NA Certification	Request filed for UL and CSA

1.2

Leistungsschütze

Basic devices up to 200 A

1

DILMP 4 pole

Rated operational current open

Conventional thermal current

Circuit symbol

For use with

AC-1

$I_{th} = I_e$ AC-1 at 50 °C

Open

40 °C 55 °C 70 °C

$I_{th} = I_e$

A	A	A	A
22	21	30	20

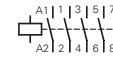

DILM32-XHI(C)...
DILA-XHI(V)(C)...

Contactors up to 200 A
4 pole

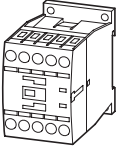

Notes

¹⁾ DILM1000-XHI... can only be fitted on the left of DILMP.

Contacts to EN 50012.

For DC operated contactors DILMP20 the following applies:

- Integrated varistor suppressor circuit.

For DC operated contactors DILMP32 - DILMP200 the following applies:

- Integrated suppressor circuit in actuating electronics.

For AC operated contactors DILMP125 - DILMP200 the following applies:

- Integrated suppressor circuit in actuating electronics.

For DILMP32-01 and DILMP45-01 the following applies:

- With mirror contact.

AC operation

Part no.
Article no.

Price
See
price
list

Std. pack

DC operation

Part no.
Article no.

Price
See
price list

Std. pack

Notes

DILMP20(230V50Hz,240V60Hz)
276970

1 off

DILMP20(24VDC)
276985

1 off

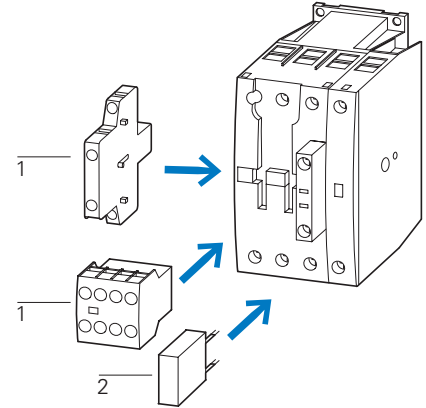
Accessories

- 1 Auxiliary contact module
- 2 Suppressor
- Further actuating voltages
- Accessories

Page

- 36
- 50
- 74
- 52









































Information relevant for export to North America



Product Standards	IEC/EN 60947-4-1; UL 508; CSA-C22.2 No.14-05; CE marking
UL File No.	E29096
UL CCN	NLDX
CSA File No.	012528
CSA Class No.	2411-03, 3211-04
NA Certification	UL Listed, CSA certified
See also	→ Page 81

DILM, DILA Auxiliary contact modules

With interlocked opposing contacts, except ...XHI(C)V

Terminal type	Pole	Conventional thermal current $I_{th} = I_e$ AC-1 at 60 °C Open $I_{th} = I_e$ A	Contact configuration	Circuit symbol	For use with	Part no. Article no.	Price See price list	Std. pack
 Top mounting auxiliary contacts Screw terminals	2 pole	16	1 N/O 1 NC		DILM(C)7-10... DILM(C)9-10... DILM(C)12-10... DILM(C)15-10... DILM(C)17-10... DILM(C)25-10... DILM(C)32-10... DILM38-...10 DILMP20... DILMP32-10... DILMP45-10... DILL...	DILM32-XHI11 277376		5 off 
	2 pole	16	— 1 NC			DILM32-XHI02 277375		5 off 
 Top mounting auxiliary contacts Screw terminals	4 pole	16	2 N/O 2 NC			DILM32-XHI22 277377		5 off 
	4 pole	16	3 N/O 1 NC			DILM32-XHI31 106112		5 off 
 Top mounting auxiliary contacts Spring-loaded terminals	2 pole	16	1 N/O 1 NC			DILM32-XHIC11 277751		5 off 
	2 pole	16	— 2 NC			DILM32-XHIC02 277750		5 off 
 Top mounting auxiliary contacts Spring-loaded terminals	4 pole	16	2 N/O 2 NC			DILM32-XHIC22 277752		5 off 
 Top mounting auxiliary contacts Screw terminals	2 pole	16	1 N/O —		DILM(C)9... DILM(C)9... DILM(C)12... DILM(C)15... DILM(C)17... DILM(C)25... DILM(C)32... DILM38... DILMP20... DILMP32... DILMP45... DILL...	DILA-XHI20 276422		5 off 
	2 pole	16	1 N/O 1 NC			DILA-XHI11 276421		5 off 
	2 pole	16	— 2 NC			DILA-XHI02 276420		5 off 
	2 pole	16	1 S _F 1 Ö _S			DILA-XHIV11 276423		5 off 
 Top mounting auxiliary contacts Screw terminals	4 pole	16	4 N/O —			DILA-XHI40 276428		5 off 
	4 pole	16	3 N/O 1 NC			DILA-XHI31 276427		5 off 
	4 pole	16	2 N/O 2 NC			DILA-XHI22 276426		5 off 
	4 pole	16	1 N/O 3 NC			DILA-XHI13 276425		5 off 
	4 pole	16	— 4 NC			DILA-XHI04 276424		5 off 
	4 pole	16	1 N/O 1 NC			DILA-XHIV22 276429		5 off 
	4 pole	16	1 S _F 1 Ö _S					

Notes



























- Auxiliary NC usable as mirror contact according to IEC/EN 60947-4-1, Annex F
- Interlocked opposing contacts according to IEC/EN 60947-5-1 Annex L, inside the auxiliary contact modules, also for the integrated auxiliary contacts of the DILM 7 - DILM32

Information relevant for export to North America

	Product Standards	IEC/EN 60947-4-1; UL 508; CSA-C22.2 No.14-05; CE marking
	UL File No.	E29184
	UL CCN	NKCR
	CSA File No.	012528
	CSA Class No.	3211-03
	NA Certification	UL Listed, CSA certified

DILM, DILA
Auxiliary contact modules

With interlocked opposing contacts, except ...XHI(C)V



Terminal type	Pole	Conventional thermal current $I_{th} = I_e$ AC-1 at 60 °C Open $I_{th} = I_e$ A	Contact configuration	Circuit symbol	For use with	Part no. Article no.	Price See price list	Std. pack
 <p>Top mounting auxiliary contacts Spring-loaded terminals</p>	2 pole	16	2 N/O	—	DILM(C)7... DILM(C)9... DILM(C)12... DILM(C)15... DILM(C)17... DILM(C)25... DILM(C)32... DILM38... DILMP20... DILMP32... DILMP45... DILL...	DILA-XHIC20 276528		5 off  
	2 pole	16	1 N/O	1 NC		DILA-XHIC11 276527		5 off  
	2 pole	16	—	2 NC		DILA-XHIC02 276526		5 off  
	2 pole	16	1 S _F	1 Ö _S		DILA-XHICV11 276529		5 off  
 <p>Top mounting auxiliary contacts Screw terminals</p>	2 pole	16	2 N/O	2 NC		DILA-XHIR22¹⁾ 139580		5 off  
	2 pole	16	1 N/O	1 NC		DILA-XHIR11 110140		5 off  
 <p>Top mounting auxiliary contacts Spring-loaded terminals</p>	4 pole	16	4 N/O	—	DILM(C)9... DILM(C)9... DILM(C)12... DILM(C)15... DILM(C)17... DILM(C)25... DILM(C)32... DILM(C)32...	DILA-XHIC40 276534		5 off  
	4 pole	16	3 N/O	1 NC		DILA-XHIC31 276533		5 off  
	4 pole	16	2 N/O	2 NC		DILA-XHIC22 276532		5 off  
	4 pole	16	1 N/O	3 NC		DILA-XHIC13 276531		5 off  
	4 pole	16	—	4 NC		DILA-XHIC04 276530		5 off  
	4 pole	16	1 N/O 1 S _F	1 NC 1 Ö _S		DILA-XHICV22 276535		5 off  

Notes

- Auxiliary NC usable as mirror contact according to IEC/EN 60947-4-1, Annex F
- Interlocked opposing contacts according to IEC/EN 60947-5-1 Annex L, inside the auxiliary contact modules, also for the integrated auxiliary contacts of the DILM 7 - DILM32

¹⁾ 1 N/C + 1 N/O above microswitch for electronic applications





































Information relevant for export to North America

 	Product Standards	IEC/EN 60947-4-1; UL 508; CSA-C22.2 No.14-05; CE marking
	UL File No.	E29184
	UL CCN	NKCR
	CSA File No.	012528
	CSA Class No.	3211-03
	NA Certification	UL Listed, CSA certified

¹⁾ NA Certification Request filed for UL and CSA

DILM Auxiliary contact modules

With interlocked opposing contacts

Connection type	Pole	conventional thermal current $I_{th} = I_e$ AC-1 at 60 °C Open $I_{th} = I_e$ A	Contact configuration N/O = normally open contact SF = N/O early make NC = normally closed contact ÖS = NC late-break	Circuit symbol	For use with	Part no. Article no.	Price See price list	Std. pack	Notes
Top mounting auxiliary contacts 	Screw terminals	2 pole	16	2 N/O –		DILM40... DILM50... DILM65... DILM72... DILM80... DILM95... DILM115... DILM150... DILM170... DILMP63... DILMP80... DILMP125... DILMP160... DILMP200...	DILM150-XHI20 277945	5 off 	Interlocked opposing contacts according to IEC/EN 60947-5-1 Annex L, inside the auxiliary contact modules Auxiliary NC usable as mirror contact according to IEC/EN 60947-4-1, Annex F
		2 pole	16	1 N/O 1 NC		DILM150-XHI11 277946	5 off 		
		2 pole	16	1 N/O 1 NC		DILM150-XHIA11 283463	5 off 		
		2 pole	16	– 2 NC		DILM150-XHI02 277947	5 off 		
Top mounting auxiliary contacts 	Screw terminals	4 pole	16	4 N/O –			DILM150-XHI40 277948	5 off 	
		4 pole	16	3 N/O 1 NC			DILM150-XHI31 277949	5 off 	
		4 pole	16	2 N/O 2 NC			DILM150-XHI22 277950	5 off 	
		4 pole	16	2 N/O 2 NC			DILM150-XHIA22 283464	5 off 	
		4 pole	16	1 N/O 3 NC			DILM150-XHI13 277951	5 off 	
		4 pole	16	– 4 NC			DILM150-XHI04 277952	5 off 	
		4 pole	16	1 N/O 1 NC 1 SF 1 ÖS			DILM150-XHIV22 277953	5 off 	
		4 pole	16	2 N/O 2 NC			DILM150-XHIV22 277953	5 off 	
High version¹⁾ 	Screw terminals	2 pole	16	2 N/O –		DILM7... DILM9... DILM12... DILM15... DILL...	DILA-XHIT20 101042	5 off 	Interlocked opposing contacts according to IEC/EN 60947-5-1 Annex L, inside the auxiliary contact modules Auxiliary NC usable as mirror contact according to IEC/EN 60947-4-1, Annex F
		2 pole	16	1 N/O 1 NC			DILA-XHIT11 101043	5 off 	
		2 pole	16	– 2 NC			DILA-XHIT02 101041	5 off 	
High version¹⁾ 	Screw terminals	4 pole	16	2 N/O 2 NC			DILA-XHIT22 101044	5 off 	

Notes ¹⁾ Suitable for the combination with electrical wiringlinks in tool-less plug connection usable with:

- DILM12-XSL
- DILM12-XRL
- DILM12-XS1
- PKZM0-XDM12
- PKZM0-XRM12
- PKZM0-XSM12

- 1 PKZM0
- 2 DILM7 - DILM15
- 3 DILA-XHIT
- 4 PKZM0-XDM12

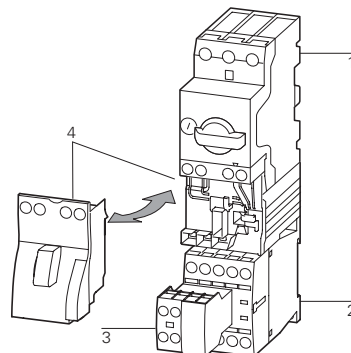

Information relevant for export to North America



Product Standards

IEC/EN 60947-4-1; UL 508;
CSA-C22.2 No.14-05; CE marking

UL File No.

E29184

UL CCN

NKCR

CSA File No.

012528











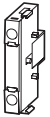















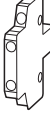







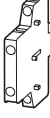

CSA Class No.

3211-03

NA Certification

UL Listed, CSA certified



DILM, DILA

Connection type	Pole	conventional thermal current $I_{th} = I_e$ AC-1 at 60 °C Open $I_{th} = I_e$ A	Contact configuration N/O = normally open contact SF = N/O early make NC = normally closed contact ÖS = NC late-break	Circuit symbol	For use with	Part no. Article no.	Price See price list	Std. pack	Notes
 <p>Side-mounting auxiliary contacts</p>	Screw terminals	1 pole	10	1 N/O –		DILM(C)7... DILM(C)9... DILM(C)12... DILM(C)15... DILMP20... DILA(C)...	DILA-XHI10-S 115948	1 off  	1)
		1 pole	10	– 1 NC			DILA-XHI01-S 115949	1 off  	
	Spring-loaded terminals	1 pole	10	1 N/O –			DILA-XHIC10-S 115950	1 off  	
		1 pole	10	– 1 NC			DILA-XHIC01-S 115951	1 off  	
 <p>Side-mounting auxiliary contacts</p>	Screw terminals	2 pole	10	1 N/O 1 NC		DILM17... DILM25... DILM32... DILM38...	DILM32-XHI1-S 101371	1 off  	Can only be left on the contactor. Cannot be combined with mechanical interlock
 <p>Side-mounting auxiliary contacts</p>	Screw terminals	2 pole	10	1 N/O 1 NC		DILM250 - DILH2600	DILM820-XHI11-SI 208281	1 off  	1)
		2 pole	10	1 N/O 1 NC			DILM820-XHI11-SA 208282	1 off  	
		2 pole	10	1 SF 1 ÖS			DILM820-XHI11V-SI 208283	1 off  	
 <p>Side-mounting auxiliary contacts</p>	Screw terminals	2 pole	10	1 N/O 1 NC		DILM40 - DILM225A DILMP63 - DILMP200	DILM1000-XHI11-SI 278425	1 off  	
		2 pole	10	1 SF 1 ÖS			DILM1000-XHIV11-SI 278426	1 off  	
		2 pole	10	1 N/O 1 NC			DILM1000-XHI11-SA 278427	1 off  	

Notes

- 1)
 - Interlocked opposing contacts according to IEC/EN 60947-5-1 Annex L, inside the auxiliary contact module, also for the integrated auxiliary contacts of the DILM7 – DILM32 (not NO early-make and NC late-break)
 - Auxiliary NC usable as mirror contact according to IEC/EN 60947-4-1, Annex F (no NC late-breaks)
 - No auxiliary contact is possible between 2 contactors with mechanical interlock.

Information relevant for export to North America

 	
2)	
Product Standards	IEC/EN 60947-4-1; UL 508; CSA-C22.2 No.14-05; CE marking E29184
UL File No.	NKCR
UL CCN	012528
CSA File No.	3211-03,3211-04
CSA Class No.	UL Listed, CSA certified
NA Certification	

1.2

Contactors

Auxiliary contact modules

1 Engineering

DILM, DILH

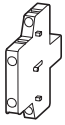

DILM1000-
XHI(V)11-SI

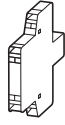

DILM820-
XHI(V)11-SI

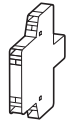

DILM1000-
XHI(V)11-SA

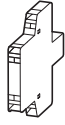

DILM820-
XHI(V)11-SA



DILM150-XHI20
DILM150-XHI11
DILM150-XHI02



DILM150-XHI40
DILM150-XHI31
DILM150-
XHI(V)22
DILM150-XHI13
DILM150-XHI04



DILM150-
XHIA11



DILM150-
XHIA22

DILM40	2 x	-	-	-	-	-	1 x	-
... DILM72	-	-	2 x	-	1 x	-	-	-
	1 x	-	-	-	-	-	-	1 x
	-	-	1 x	-	-	1 x	-	-
DILM80	2 x	-	2 x	-	-	-	-	-
... DILM170	2 x	-	-	-	-	-	-	1 x
	2 x	-	-	-	-	-	1 x	-
	-	-	2 x	-	-	1 x	-	-
	-	-	2 x	-	1 x	-	-	-
DILM185A	2 x	-	2 x	-	-	-	-	-
DILM222A	2 x	-	-	-	-	-	-	-
DILM250 DILM1600	-	2 x	-	2 x	-	-	-	-
DILH1400	-	2 x	-	2 x	-	-	-	-
... DILH2600								

Notes

Side mounting auxiliary contacts

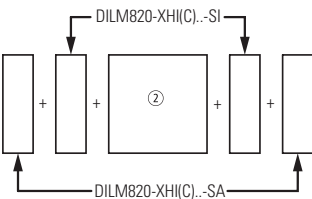
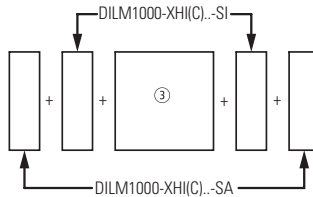
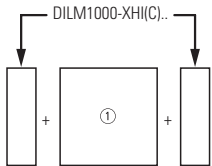

- ① DILM40 – DILM72
- ② DILM250 – DILH2600
- ③ DILM80-DILM225A

- Interlocked opposing contacts according to IEC/EN 60947-5-1 Annex L, inside the auxiliary contact module (not N/O early close and N/C late open)
- Auxiliary contacts can be used as mirror contacts according to IEC/EN 60947-4-1, Annex F (not N/C late open)
- No auxiliary contact is possible between two contactors with mechanical interlock.
- 2 auxiliary contacts DILM820-XHI11-SI are already built into the contactors DILM250 to DILH2600/22.
- 2 DILM1000-XHI11-SI auxiliary contacts are already installed in DILM185A and DILH225A contactors.

Ordering

DILK

Three-phase capacitors
50 – 60 Hz
Open

Circuit symbol

Part no.
Article no.

Price
See price list

Std. pack

230 V	400 V	525 V	690 V
-------	-------	-------	-------

kvar	kvar	kvar	kvar
------	------	------	------

7.5	12.5	16.7	20
-----	------	------	----

11	20	25	33.3
----	----	----	------

15	25	33.3	40
----	----	------	----

20	33.3	40	55
----	------	----	----

25	50	65	85
----	----	----	----

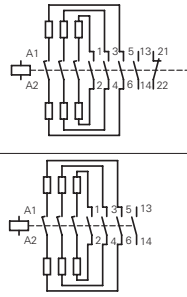

DILK12-11(230V50Hz,240V60Hz) 293988	1 off		
DILK20-11(230V50Hz,240V60Hz) 294010	1 off		
DILK25-11(230V50Hz,240V60Hz) 294032	1 off		
DILK33-10(230V50Hz,240V60Hz) 294054	1 off		
DILK50-10(230V50Hz,240V60Hz) 294076	1 off		

With series resistors
Basic Units

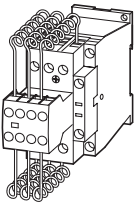

Notes

Weld-resistant for capacitors with inrush current peaks up to $180 \times I_N$
 With group compensation multi-stage capacitor banks are connected to the mains as required. This can cause, transient currents of up to $180 \times I_e$ to flow between the capacitors.
 The capacitors are pre-charged via the early-make auxiliary contacts and the fitted wire resistors, thereby reducing the inrush current. The main contacts then close after a time lag and carry the continuous current.
 The contactors for capacitors are weld-resistant with inrush current peaks up to $180 \times I_e$ due to their special contacts.
 DILK... cannot be combined with other auxiliary contacts.
 For the switching of reactive-power compensation equipment please see Engineering notes on power factor correction → page 33.

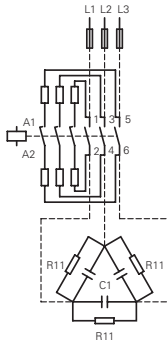

Accessories	Page
Enclosures	
Accessories	→ 52
Further actuating voltages	→ 76

Information relevant for export to North America



Product Standards	IEC/EN 60947-4-1; UL 508; CSA-C22.2 No.14-05; CE marking
UL File No.	E29096
UL CCN	NLDX
CSA File No.	012528
CSA Class No.	3211-04
NA Certification	UL Listed, CSA certified
See also	Further approvals → Page 66

1.2

Contactors

Contactors for power factor correction

1 Engineering

DILM, DILK

Part no.	Page	Switching power			
		230 V	400 V 420 V 440 V	525 V	690 V
Ordering data		kvar	kvar	kvar	kvar
Individual compensation, open version					
DILM7-...(…)	→ 18	1.5	3	3.5	5
DILM9-...(…)	→ 18	2	4	4.5	6
DILM12-...(…)	→ 18	2.5	4.5	5.5	7
DILM15-...(…)	→ 18	2.5	4.5	5.5	7
DILM17-...(…)	→ 18	6.5	12	14.5	19
DILM25-...(…)	→ 18	7	13.5	16	21
DILM32-...(…)	→ 18	7.5	14.5	17	22.5
DILM40(…)	→ 20	11	20.5	24.5	32
DILM50(…)	→ 20	11.5	22	26	34.5
DILM65(…)	→ 20	12.5	23.5	28	37
DILM80(…)	→ 20	16	30.5	36.5	48
DILM95(…)	→ 20	18	34	41	54
DILM115(…)	→ 20	24	46	54.5	72
DILM150(…)	→ 20	28	53	63.5	83.5
DILM185A(…)	→ 30	87	150	190	150
DILM300A(…)	→ 30	115	200	265	200
DILM580(…)	→ 30	175	300	400	300
Group compensation, with choke, open version					
DILM7-...(…)	→ 18	4	7	7.5	12
DILM9-...(…)	→ 18	5	8	10	14
DILM12-...(…)	→ 18	5.5	10	12	16
DILM15-...(…)	→ 18	5.5	10	12	16
DILM17-...(…)	→ 18	7.5	18	20	28
DILM25-...(…)	→ 18	10	20	23	30
DILM32-...(…)	→ 18	12.5	25	25	32
DILM40(…)	→ 20	15	30	30	40
DILM50(…)	→ 20	20	40	40	48
DILM65(…)	→ 20	25	50	50	57
DILM80(…)	→ 20	30	60	70	90
DILM95(…)	→ 20	35	70	80	104
DILM115(…)	→ 20	50	95	100	125
DILM150(…)	→ 20	55	115	115	152
DILM185A(…)	→ 30	80	150	200	260
DILM225A(…)	→ 30	100	175	230	300
DILM250(…)	→ 30	110	190	260	340
DILM300A(…)	→ 30	130	225	290	390
DILM400(…)	→ 30	160	280	370	480
DILM500(…)	→ 30	220	390	500	680
Group compensation, without choke, open version					
DILK12-...(…)	→ 41	7.5	12.5	16.7	20
DILK20-...(…)	→ 41	11	20	25	33.3
DILK25-...(…)	→ 41	15	25	33.3	40
DILK33-...(…)	→ 41	20	33.3	40	55
DILK50-...(…)	→ 41	25	50	65	85
DILM185A(…)	→ 30	66	115	145	115
DILM300A(…)	→ 30	85	150	195	150
DILM580(…)	→ 30	145	250	333	250

Notes

Use of the contactors DILM without series resistor for group compensation

When using the contactors for group compensation in a system without chokes each capacitor must have a minimum induction of approx. 6 µH to limit the peak inrush current. This corresponds to an air-cored coil with 5 windings and a coil diameter of approximately Ø 140 mm. The conductor cross section must correspond to the rated operational current.

1.2

Contactors combinations

Star-delta combinations

Ordering

1

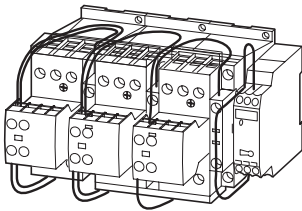
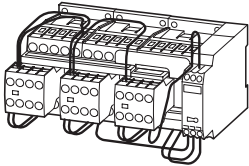
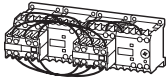

Star-delta combinations SDAINL

Operating frequency: maximum 30 starts per hour

Rated operational current AC-3	Max. rated operational power for three-phase motors, 50 - 60 Hz				Max. change-over time s	Part no. Article no.	Price See price list	Std. pack
	400 V	230 V	400 V	500 V				
I_e A	P kW	P kW	P kW	P kW				
12	4	5.5	5.5	–	< 30	SDAINLEM(230V50Hz) 051840		1 off
12	3	5.5	5.5	5.5	< 20	SDAINLM12(230V50Hz) 278286		1 off
12	3	5.5	5.5	5.5	< 20	SDAINLM12(400V50Hz) 101380		1 off
12	3	5.5	5.5	5.5	< 20	SDAINLM12(24VDC) 100416		1 off
16	4	7.5	7.5	7.5	< 20	SDAINLM16(230V50Hz) 278311		1 off
16	4	7.5	7.5	7.5	< 20	SDAINLM16(400V50Hz) 101381		1 off
16	4	7.5	7.5	7.5	< 20	SDAINLM16(24VDC) 100417		1 off
22	5.5	11	11	11	< 20	SDAINLM22(230V50Hz) 278336		1 off
22	5.5	11	11	11	< 20	SDAINLM22(400V50Hz) 101382		1 off
22	5.5	11	11	11	< 20	SDAINLM22(24VDC) 100418		1 off
30	7.5	15	18.5	18.5	< 20	SDAINLM30(230V50Hz) 278361		1 off
30	7.5	15	18.5	18.5	< 20	SDAINLM30(400V50Hz) 101383		1 off
30	7.5	15	18.5	18.5	< 20	SDAINLM30(RDC24) 100419		1 off
45	11	22	30	22	< 20	SDAINLM45(230V50Hz) 278386		1 off
45	11	22	30	22	< 20	SDAINLM45(400V50Hz) 101384		1 off
45	11	22	30	22	< 20	SDAINLM45(RDC24) 100420		1 off
55	15	30	37	30	< 20	SDAINLM55(230V50Hz) 278411		1 off
55	15	30	37	30	< 20	SDAINLM55(400V50Hz) 101385		1 off
55	15	30	37	30	< 20	SDAINLM55(RDC24) 100421		1 off
70	18.5	37	45	37	< 20	SDAINLM70(230V50Hz) 239895		1 off
70	18.5	37	45	37	< 20	SDAINLM70(400V50Hz) 101386		1 off
90	22	45	55	45	< 20	SDAINLM90(230V50Hz) 239937		1 off
115	30	55	75	55	< 20	SDAINLM115(230V50Hz) 239963		1 off
140	37	75	90	90	< 20	SDAINLM140(230V50Hz) 240009		1 off
165	45	90	110	132	< 20	SDAINLM165(230V50Hz) 240035		1 off
200	55	110	132	160	< 20	SDAINLM200(230V50Hz) 101010		1 off
260	75	132	160	160	< 20	SDAINLM260(230V50Hz) 101031		1 off

Individual components of the combination				Spare auxiliary contacts			Notes
Mains contactor Q11	Delta contactor Q15	Star contactor Q13	Timing relays K1	Q11	Q13	Q15	
Part no.	Part no.	Part no.	Part no.				

DILEM-10 + 22DILEM	DILEM-01	DILEM-10 + 02DILEM	DILET		—	—	<p>Main circuit: Depending on the type of coordination required (i.e. Type "1" or Type "2") it must be established whether the fuse protection and the input wiring for the mains contactor and delta contactor are to be common or separate.</p> <p>The following applies for SDAINLM 140 – SDAINLM 260:</p> <ul style="list-style-type: none"> On the mounting plate. <p>Circuit diagrams, Star-delta combinations → page 46</p>
DILM7-10 + DILA-XHI20	DILM7-01 + DILA-XHI20	DILM7-01 + DILA-XHI20	ETR4-51				
DILM7-10 + DILA-XHI20	DILM7-01 + DILA-XHI20	DILM7-01 + DILA-XHI20	ETR4-51				
DILM7-10 + DILA-XHI20	DILM7-01 + DILA-XHI20	DILM7-01 + DILA-XHI20	ETR4-51				
DILM9-10 + DILA-XHI20	DILM9-01 + DILA-XHI20	DILM7-01 + DILA-XHI20	ETR4-51				
DILM9-10 + DILA-XHI20	DILM9-01 + DILA-XHI20	DILM7-01 + DILA-XHI20	ETR4-51				
DILM9-10 + DILA-XHI20	DILM9-01 + DILA-XHI20	DILM7-01 + DILA-XHI20	ETR4-51				
DILM12-10 + DILA-XHI20	DILM12-01 + DILA-XHI20	DILM7-01 + DILA-XHI20	ETR4-51				
DILM12-10 + DILA-XHI20	DILM12-01 + DILA-XHI20	DILM7-01 + DILA-XHI20	ETR4-51				
DILM12-10 + DILA-XHI20	DILM12-01 + DILA-XHI20	DILM7-01 + DILA-XHI20	ETR4-51				
DILM12-10 + DILA-XHI20	DILM12-01 + DILA-XHI20	DILM7-01 + DILA-XHI20	ETR4-51				
DILM17-10 + DILA-XHI20	DILM17-01 + DILA-XHI20	DILM17-01 + DILA-XHI20	ETR4-51				
DILM17-10 + DILA-XHI20	DILM17-01 + DILA-XHI20	DILM17-01 + DILA-XHI20	ETR4-51				
DILM17-10 + DILA-XHI20	DILM17-01 + DILA-XHI20	DILM17-01 + DILA-XHI20	ETR4-51				
DILM17-10 + DILA-XHI20	DILM17-01 + DILA-XHI20	DILM17-01 + DILA-XHI20	ETR4-51				
DILM25-10 + DILA-XHI20	DILM25-01 + DILA-XHI20	DILM17-01 + DILA-XHI20	ETR4-51				
DILM25-10 + DILA-XHI20	DILM25-01 + DILA-XHI20	DILM17-01 + DILA-XHI20	ETR4-51				
DILM25-10 + DILA-XHI20	DILM25-01 + DILA-XHI20	DILM17-01 + DILA-XHI20	ETR4-51				
DILM32-10 + DILA-XHI20	DILM32-01 + DILA-XHI20	DILM25-01 + DILA-XHI20	ETR4-51				
DILM32-10 + DILA-XHI20	DILM32-01 + DILA-XHI20	DILM25-01 + DILA-XHI20	ETR4-51				
DILM32-10 + DILA-XHI20	DILM32-01 + DILA-XHI20	DILM25-01 + DILA-XHI20	ETR4-51				
DILM40 + DILM150-XHI31	DILM40 + DILM150-XHI11	DILM40 + DILM150-XHI11	ETR4-51		—	—	
DILM40 + DILM150-XHI31	DILM40 + DILM150-XHI11	DILM40 + DILM150-XHI11	ETR4-51		—	—	
DILM50 + DILM150-XHI31	DILM50 + DILM150-XHI11	DILM40 + DILM150-XHI11	ETR4-51		—	—	
DILM65 + DILM150-XHI31	DILM65 + DILM150-XHI11	DILM40 + DILM150-XHI11	ETR4-51		—	—	
DILM80 + DILM150-XHI31	DILM80 + DILM150-XHI11	DILM50 + DILM150-XHI11	ETR4-51		—	—	
DILM95 + DILM150-XHI31	DILM95 + DILM150-XHI11	DILM65 + DILM150-XHI11	ETR4-51		—	—	
DILM115 + DILM150-XHI31	DILM115 + DILM150-XHI11	DILM80 + DILM150-XHI11	ETR4-51		—	—	
DILM150 + DILM150-XHI31	DILM150 + DILM150-XHI11	DILM95 + DILM150-XHI11	ETR4-51		—	—	

Main circuit:
Depending on the type of coordination required (i.e. Type "1" or Type "2") it must be established whether the fuse protection and the input wiring for the mains contactor and delta contactor are to be common or separate.

The following applies for SDAINLM 140 – SDAINLM 260:

- On the mounting plate.

Circuit diagrams, Star-delta combinations → page 46

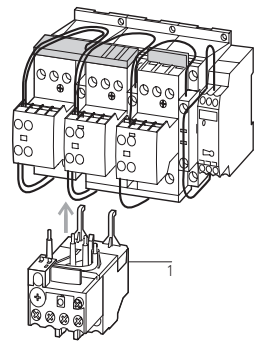

Accessories
1 Overload relay
Accessories

Page
→ Chapter 1.2
→ 52

1.2 Contactor combinations

Star-delta combinations

1 Engineering

SDAINL Circuit diagrams, Star-delta combinations

SDAINLEM

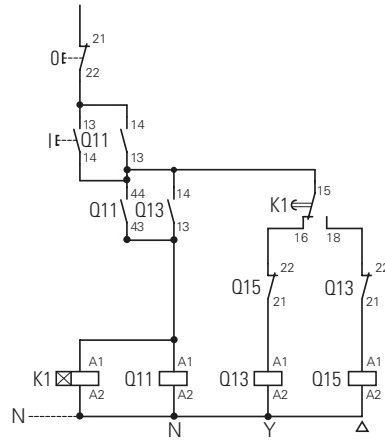
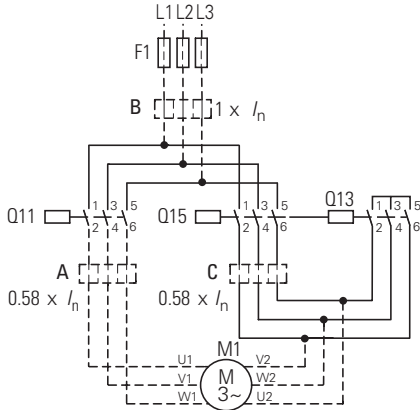

SDAINLM12...SDAINLM55

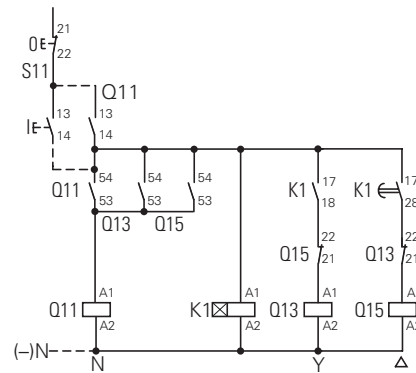
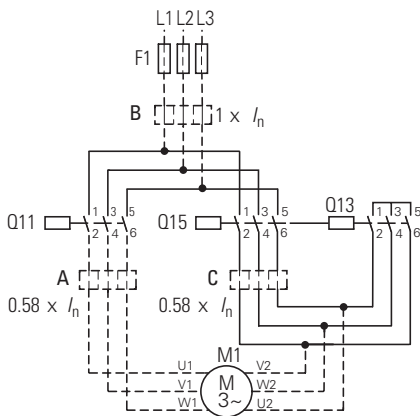

SDAINLM70...SDAINLM260

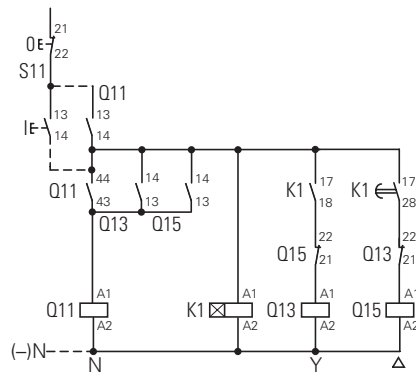
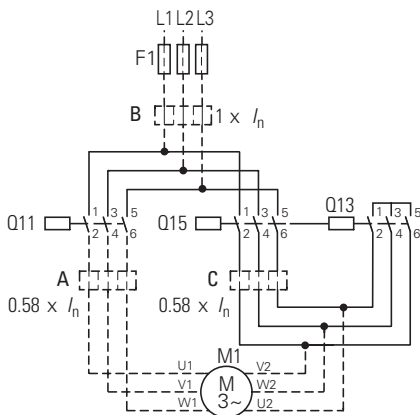

Overload relay settings

- A:** $I_N \times 0.58$
Motor protected in Y and Δ - positions
 - B:** $I_N \times 1$
Only partial motor protection in Y position
 - C:** $I_N \times 0.58$
Motor not protected in Y position
- Timing relay set to approx. 10 s
Main circuit:

Starting

- ≤ 15 s
- 15 – 40 s
- > 40 s

Depending on the type of coordination required (i.e. Type "1" or Type "2") it must be established whether the fuse protection and the input wiring for the mains contactor and delta contactor are to be common or separate.

SDAINL Components for self-assembly of star-delta combinations

Maximum operational rating of AC motors 50 - 60 Hz
AC-3

Changeover time¹⁾

Individual components of the combination

Spare auxiliary contacts

230 V kW	400 V kW	500 V kW	690 V kW	1000 V kW	up to 12 s	up to 20 s	up to 30 s	Coil to EN 50005 Switching element to EN 50005 and EN 50012				Q11	Q15	Q13
								Mains contactor Q11 Part no. DIL	Delta contactor Q15 Part no. DIL	Star contactor Q13 Part no. DIL	Timing relay K1 Part no.			
90	160	200	250	132	●	●	●	M185A/22	M185A/22	M115/22	ETR4-51			
110	200	250	315	160	●	●	—	M225A/22	M225A/22	M150/22	ETR4-51			
132	250	315	400	200	●	●	●	M250/22	M250/22	M185A/22	ETR4-51			
160	300	355	450	200	●	●	●	M300A/22	M300A/22	M185A/22	ETR4-51			
200	355	450	560	220	●	●	—	M400/22	M400/22	M250/22	ETR4-51			
250	450	560	600	220	●	●	●	M500/22	M500/22	M300A/22	ETR4-51			
300	560	710	900	355	●	●	●	M580/22	M580/22	M400/22	ETR4-51			
350	630	750	950	355	●	●	●	M650/22	M650/22	M400/22	ETR4-51			
400	710	900	1200	1400	●	●	●	M750/22	M750/22	M580/22	ETR4-51			
450	800	950	1300	1400	●	●	●	M820/22	M820/22	M580/22	ETR4-51			
560	1000	1200	1700	1700	●	●	—	M1000/22	M1000/22	M650/22	ETR4-51			

Notes

¹⁾ Longer changeover times please enquire

Components for self-assembly

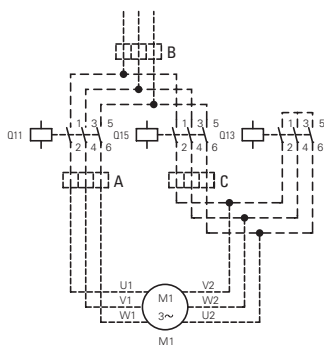

Notes

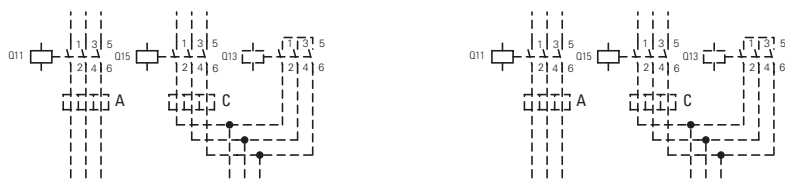

Overload relay settings

Timing relay set to approx. 10 s

I_N	Starting	Main circuit: Depending on the coordination type required (i.e. Type "1" or Type "2") it must be established whether the fuse protection and the input wiring for the mains contactor and delta contactor are to be common or separate.
A x 0.58 Motor protection in Y and Δ positions	≤ 15 s	
B x 1 In Y position only limited motor protection	15 – 40 s	Control circuit: If the combinations are to be used within the scope of IEC/EN 60 204 Part 1, VDE 0113 Part 1, then Point 9.1.1 regarding the supply of control circuits, must be observed.
C x 0.58 Motor not protected in Y position	> 40 s	



































1.2

Contactors combinations

Reversing combinations

1 Ordering

DIUL reversing combinations

Rated operational current	Max. motor rating for three-phase motors 50 - 60 Hz						Part no. Article no.	Price See price list	Std. pack
	AC-3 400 V	AC-3			AC-4				
I_e A	220 V 230 V	380 V 400 V	660 V 690 V	220 V 230 V	380 V 400 V	660 V 690 V			
	P kW	P kW	P kW	P kW	P kW	P kW			
	9	2.2	4	4	1.5	3	3	DIULEM/21(MV(230V50Hz))¹⁾ 051849	1 Off  
	9	2.2	4	4	1.5	3	3	DIULEM/21(MV-G(24VDC))²⁾ 214655	1 Off  
	7	2.2	3	3.5	1	2.2	2.9	DIULM7/21(230V50Hz)²⁾ 278061	1 Off  
	7	2.2	3	3.5	1	2.2	2.9	DIULM7/21(24VDC)²⁾ 107021	1 Off  
	9	2.5	4	4.5	1.5	2.5	3.6	DIULM9/21(230V50Hz)²⁾ 278086	1 Off  
	9	2.5	4	4.5	1.5	2.5	3.6	DIULM9/21(24VDC)²⁾ 107022	1 Off  
	12	3.5	5.5	6.5	2	3	4.4	DIULM12/21(230V50Hz)²⁾ 278111	1 Off  
	12	3.5	5.5	6.5	2	3	4.4	DIULM12/21(24VDC)²⁾ 107023	1 Off  
	18	5	7.5	11	2.5	4.5	6.5	DIULM17/21(230V50Hz)²⁾ 278136	1 Off  
	18	5	7.5	11	2.5	4.5	6.5	DIULM17/21(RDC24)²⁾ 107024	1 Off  
	25	7.5	11	14	3.5	6	8.5	DIULM25/21(230V50Hz)²⁾ 278161	1 Off  
	25	7.5	11	14	3.5	6	8.5	DIULM25/21(RDC24)²⁾ 107025	1 Off  
	32	10	15	17	4	7	10	DIULM32/21(230V50Hz)²⁾ 278186	1 Off  
	32	10	15	17	4	7	10	DIULM32/21(RDC24)²⁾ 107026	1 Off  
	40	12.5	18.5	23	5	9	12	DIULM40/11(230V50Hz)²⁾ 278211	1 Off  
	50	15.5	22	30	6	10	14	DIULM50/11(230V50Hz)²⁾ 278236	1 Off  
	65	20	30	35	7	12	17	DIULM65/11(230V50Hz)²⁾ 278261	1 Off  

AC operation

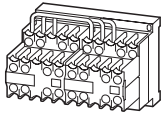

AC operation

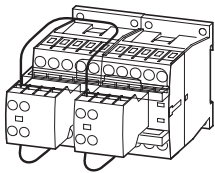

AC operation

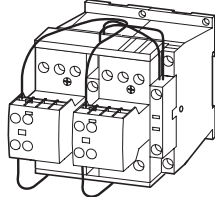

Information relevant for export to North America



1) Product Standards	IEC/EN 60947-4-1; UL 508; CSA-C22.2 No.14-05; CE marking
UL File No.	E29096
UL CCN	NLDX
CSA File No.	012528
CSA Class No.	3211-04
NA Certification	UL Listed, CSA certified

Information relevant for export to North America



2) Product Standards	IEC/EN 60947-4-1; UL 508; CSA-C22.2 No.14-05; CE marking
UL File No.	E29096
UL CCN	NLDX
CSA File No.	012528
CSA Class No.	2411-03, 3211-04
NA Certification	UL Listed, CSA certified

Individual components of the combination		Spare auxiliary contacts			Circuit diagram	Notes
Contactor Q11	Contactor Q12	Q11	Q12	Mechanical interlock		
Part no.	Part no.					
DILEM-10 + 11DILEM	DILEM-10 + 11DILEM			+		 Accessories 1 Overload relay Accessories Reversing contactors
DILEM-10-G + 11DILEM	DILEM-10-G + 11DILEM			+		
DILM7-01 + DILA-XHI20	DILM7-01 + DILA-XHI20			+		
DILM7-01 + DILA-XHI20	DILM7-01 + DILA-XHI20			+		Accessories 1 Overload relay Accessories Reversing contactors DIULM7/21 to DIULM65/11 with mechanical interlock
DILM9-01 + DILA-XHI20	DILM9-01 + DILA-XHI20			+		
DILM9-01 + DILA-XHI20	DILM9-01 + DILA-XHI20			+		
DILM12-01 + DILA-XHI20	DILM12-01 + DILA-XHI20			+		
DILM12-01 + DILA-XHI20	DILM12-01 + DILA-XHI20			+		
DILM17-01 + DILA-XHI20	DILM17-01 + DILA-XHI20			+		
DILM17-01 + DILA-XHI20	DILM17-01 + DILA-XHI20			+		
DILM25-01 + DILA-XHI20	DILM25-01 + DILA-XHI20			+		
DILM25-01 + DILA-XHI20	DILM25-01 + DILA-XHI20			+		
DILM32-01 + DILA-XHI20	DILM32-01 + DILA-XHI20			+		
DILM32-01 + DILA-XHI20	DILM32-01 + DILA-XHI20			+		
DILM32-01 + DILA-XHI20	DILM32-01 + DILA-XHI20			+		
DILM40 + DILM150-XHI11	DILM40 + DILM150-XHI11	-	-	+		
DILM50 + DILM150-XHI11	DILM50 + DILM150-XHI11	-	-	+		
DILM65 + DILM150-XHI11	DILM65 + DILM150-XHI11	-	-	+		

Page
 → Chapter 1.2
 → 52

1.2

Contactor relays, contactors

Suppressor circuit

1 Ordering

DILM...-XSP... Suppressor circuits

Voltage U_s V	For use with	Circuit symbol	Part no. Article no.	Price See price list	Std. pack	Notes	
24 - 48 AC 110 - 240 AC 240 - 500 AC	DILM7 - DILM15 DILMP20 DILA		DILM12-XSPR48 281199		10 Off 	For AC operated contactors 50 - 60 Hz. DC operated contactors and DILM115 and DILM150 have an integrated suppressor. Note drop-out delay.	
			DILM12-XSPR240 281200		10 Off 		
			DILM12-XSPR500 281201		10 Off 		
24 - 48 AC 110 - 240 AC 240 - 500 AC	DILM17 - DILM32 DILK12 - DILK25 DILL... DILMP32 - DILMP45		DILM32-XSPR48 281202		10 Off 		
			DILM32-XSPR240 281203		10 Off 		
			DILM32-XSPR500 281204		10 Off 		
24 - 48 AC 110 - 240 AC 240 - 500 AC	DILM40 - DILM95 DILK33 - DILK50 DILMP63 - DILMP200		DILM95-XSPR48 281205		10 Off 		
			DILM95-XSPR240 281206		10 Off 		
			DILM95-XSPR500 281207		10 Off 		
24 - 48 AC 48 - 130 AC 130 - 240 AC 240 - 500 AC	DILM7 - DILM15 DILMP20 DILA		DILM12-XSPV48 281208		10 Off 		For AC operated contactors 50 - 60 Hz. DC operated contactors and DILM115 and DILM150 have an integrated suppressor. Note drop-out delay.
			DILM12-XSPV130 281209		10 Off 		
			DILM12-XSPV240 281210		10 Off 		
24 - 48 AC 48 - 130 AC 130 - 240 AC 240 - 500 AC	DILM17 - DILM32 DILK12 - DILK25 DILL... DILMP32 - DILMP45		DILM12-XSPV500 281211		10 Off 		
			DILM32-XSPV48 281212		10 Off 		
			DILM32-XSPV130 281213		10 Off 		
24 - 48 AC 48 - 130 AC 130 - 240 AC 240 - 500 AC	DILM40 - DILM95 DILK33 - DILK50 DILMP63 - DILMP200		DILM32-XSPV240 281214		10 Off 		
			DILM32-XSPV500 281215		10 Off 		
			DILM95-XSPV48 281216		10 Off 		
24 - 48 AC 48 - 130 AC 130 - 240 AC 240 - 500 AC	DILM40 - DILM95 DILK33 - DILK50 DILMP63 - DILMP200		DILM95-XSPV130 281217		10 Off 		
			DILM95-XSPV240 281218		10 Off 		
			DILM95-XSPV500 281219		10 Off 		

Information relevant for export to North America



Product Standards	IEC/EN 60947-4-1; UL 508; CSA-C22.2 No.14-05; CE marking
UL File No.	E29096
UL CCN	NLDX
CSA File No.	227038
CSA Class No.	3211-07
NA Certification	UL Listed, CSA certified

Ordering

**DILM...-XSP...
Suppressor circuits**

Varistor suppressors with integrated LED

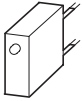

Diode suppressor



Voltage U_s V	For use with	Circuit symbol	Part no. Article no.	Price See price list	Std. pack	Notes
24 - 48 AC	DILM7 - DILM15 DILMP20		DILM12-XSPVL48 281220		10 Off 	For AC operated contactors 50 - 60 Hz. DC operated contactors and DILM115 and DILM150 have an integrated suppressor. Note drop-out delay.
130 - 240 AC	DILA		DILM12-XSPVL240 281221		10 Off 	
24 - 48 AC	DILM17 - DILM32 DILK12 - DILK25		DILM32-XSPVL48 281222		10 Off 	
130 - 240 AC	DILL... DILMP32 - DILMP45		DILM32-XSPVL240 281223		10 Off 	
24 - 48 AC	DILM40 - DILM95 DILK33 - DILK50		DILM95-XSPVL48 281224		10 Off 	
130 - 240 AC	DILMP63 - DILMP200		DILM95-XSPVL240 281225		10 Off 	
12 - 250 DC	DILM7 - DILM15 DILMP20 DILA		DILM12-XSPD 101672		10 Off 	DC operated contactors. Prevention of negative switch-off voltage when the contactor is used together with a safety PLC.















Information relevant for export to North America

	Product Standards	IEC/EN 60947-4-1; UL 508; CSA-C22.2 No.14-05; CE marking
	UL File No.	E29096
	UL CCN	NLDX
	CSA File No.	227038
	CSA Class No.	3211-07
	NA Certification	UL Listed, CSA certified

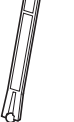

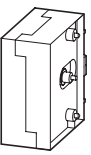













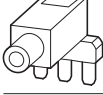

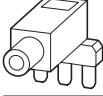

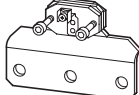
1.2 Contactor relays, contactors

Accessories

1 DILM...-XDILM...-XVB, DILM...-XMV



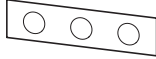





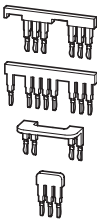

	For use with	Part no. Article no.	Price See price list	Std. pack	Notes	Information relevant for export to North America 
Mechanical interlocks						
For mechanically linking contactors in combinations 0 mm distance between contactors.						
	DILM7 - DILM72 DILA	DILM32-XVB 281227		50 Off 	–	Product Standards IEC/EN 60947-4-1; UL 508; CSA-C22.2 No.14-05; CE marking UL File No. E36332 UL CCN NLRV CSA File No. 012528 CSA Class No. 3211-05 NA Certification UL Listed, CSA certified
	DILM80 - DILM170	DILM150-XVB 281226		10 Off 	–	Product Standards IEC/EN 60947-4-1; UL 508; CSA-C22.2 No.14-05; CE marking UL File No. E29184 UL CCN NKCR CSA File No. 012528 CSA Class No. 3211-03 NA Certification UL Listed, CSA certified
Mechanical interlocks						
	DILM7 - DILM15 DILMP20 DILA	DILM12-XMV 281196		1 Off 	For two contactors with AC or DC operation arranged vertically or horizontally. Distance between contactors 0 mm, including contactor connector Mechanical lifespan 2.5 x 10 ⁶ operations. DILM 150-XMV including mounting plate for contactors. Additional auxiliary contact modules possible. →36	Product Standards IEC/EN 60947-4-1; UL 508; CSA-C22.2 No.14-05; CE marking UL File No. E29096 UL CCN NLDX CSA File No. 012528 CSA Class No. 2411-03 NA Certification UL Listed, CSA certified
	DILM17 - DILM38	DILM32-XMV 281197		1 Off 		
	DILM40 - DILM72	DILM65-XMV 281198		1 Off 		
	DILM80 - DILM170	DILM150-XMV 240081		1 Off 		
	DILM185A, DILM225A, DILM250, DILM300A, DILM400, DILM500, DILM570	DILM500-XMV 208289		1 Off 	For contactors with the same or different magnet systems mounted horizontally or vertically, mechanical lifespan 5 x 10 ⁶ operations. No auxiliary contact permitted between mechanical interlock and contactor. Combination only with consecutive installation sizes or DILM185A - DILM570.	Product Standards IEC/EN 60947-4-1; UL 508; CSA-C22.2 No.14-05; CE marking UL File No. E29184 UL CCN NKCR CSA File No. 012528 CSA Class No. 3211-04 NA Certification UL Listed, CSA certified
	DILM580, DILM650, DILM750, DILM820 DILM1000	DILM820-XMV 208288		1 Off 		
Set of spare parts for mechanical interlock						
Ball for mechanical interlock, incl. contactor connector.						
–	DILM80 - DILM170	DILM150-XMVE 107020		1 Off 		UL/CSA certification not required

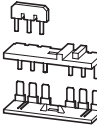
DILM...-XP1, DILM...-XS1

	For use with	Circuit symbol	Part no. Article no.	Price See price list	Std. pack	Notes	Information relevant for export to North America 
Paralleling links for main contacts							
Consisting of 2 paralleling links							
	DILM7 - DILM15		DILM12-XP1 281193		5 Off 	4th pole can be broken off AC-1 current carrying capacity of the open contactor increases by a factor of 2.5 Protected against accidental contact in accordance with VDE 0106 Part 100	Product Standards UL File No. UL CCN CSA File No. CSA Class No. NA Certification
	DILM17 - DILM32		DILM32-XP1 281194		5 Off 	A cover is included with DILM185-XP1 for protection against accidental contact. Connection cross section for DILM...-XP1 Technical data	IEC/EN 60947-4-1; UL 508; CSA-C22.2 No.14-05; CE marking E29096 NLDX 012528 3211-03 UL Listed, CSA certified
	DILM40 - DILM72		DILM65-XP1 281195		1 Off 		
	DILM80 - DILM170		DILM150-XP1 284769		1 Off 		
	DILM185A		DILM185-XP1 208292		1 Off		–
Star-point bridges							
	DILM7 - DILM15		DILM12-XS1 281190		20 Off 	<ul style="list-style-type: none"> Designed as tool-less plug connection Use as DILA-XHIT... contactor auxiliary contact → 38 	Product Standards UL File No. UL CCN CSA File No. CSA Class No. NA Certification
	DILM17 - DILM32		DILM32-XS1 281191		20 Off 	Use as DILA-XHIT... contactor auxiliary contact → 38	Product Standards UL File No. UL CCN CSA File No. CSA Class No. NA Certification
	DILM40 - DILM72		DILM65-XS1 281192		10 Off 	–	IEC/EN 60947-4-1; UL 508; CSA-C22.2 No.14-05; CE marking E36332 NLRV 012528 3211-04 UL Listed, CSA certified
	DILM80 - DILM170		DILM150-XS1 284768		5 Off 	–	Product Standards UL File No. UL CCN CSA File No. CSA Class No. NA Certification
	DILM185A - DILM400		DILM400-XS1 208291		1 Off 	A cover is included for protection against accidental contact.	Product Standards UL File No. UL CCN CSA File No. CSA Class No. NA Certification
	DILM500		DILM500-XS1 208290		1 Off 	A cover is included for protection against accidental contact.	Product Standards UL File No. UL CCN NA Certification









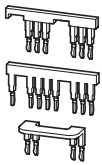

DILM...-XSL Star-delta wiring kit

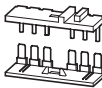
Main current wiring for star-delta combination Including star-point bridge







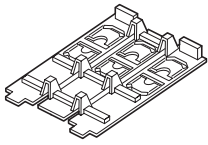

For use with	Part no. Article no.	Price See price list	Std. pack	Notes	Information relevant for export to North America
	DILM7/9/12/15 mains contactors	DILM12-XSL 283130	1 Off 	<ul style="list-style-type: none"> Designed for tool-less plug connection Use as DILA-XHIT... contactor auxiliary contact → 38 <p>The following control cables are integrated in addition to electrical interlock:</p> <ul style="list-style-type: none"> Q13: A1 - Q15: 21 Q13: 21 - Q15: A1 Q13: A2 - Q15: A2 	 <p>Product Standards IEC/EN 60947-4-1; UL 508; CSA-C22.2 No.14-05; CE marking 012528</p> <p>CSA File No. 012528</p> <p>CSA Class No. 3211-05</p> <p>NA Certification UL Listed, CSA certified</p>
	DILM7/9/12/15 delta contactors				
	DILM7/9/12/15 star contactors				
	DILM17/25/32 mains contactors	DILM32-XSL 283131	1 Off 	<p>Consists of the following connection bridges:</p> <ul style="list-style-type: none"> Mains - delta contactors Delta - star contactors Star-point bridge 	<p>Product Standards IEC/EN 60947-4-1; UL 508; CSA-C22.2 No.14-05; CE marking</p> <p>UL File No. E36332</p> <p>UL CCN NLRV</p> <p>CSA File No. 012528</p> <p>CSA Class No. 3211-04</p> <p>NA Certification UL Listed, CSA certified</p>
	DILM17/25/32 delta contactors				
	DILM17/25/32 star contactors				
	DILM40/50/65 mains contactors	DILM65-XSL 101058	1 Off 		
	DILM40/50/65 delta contactors				
	DILM40/50/65 star contactors				
	DILM 80/95 mains contactors	DILM95-XSL 101486	1 Off		
	DILM80/95 delta contactors				
	DILM50/65 star contactors				
	DILM 115/150 mains contactors	DILM150-XSL 101487	1 Off 		<p>Product Standards IEC/EN 60947-4-1; UL 508; CSA-C22.2 No.14-05; CE marking</p> <p>UL File No. E36332</p> <p>UL CCN NLRV</p> <p>CSA File No. 012528</p> <p>CSA Class No. 2411-03,3211-04</p> <p>NA Certification UL Listed, CSA certified</p>
	DILM115/150 delta contactors				
	DILM80/95/115 star contactors				
	DILM 185/225 mains contactors	DILM225-XSL 101488	1 Off		
	DILM185/225 delta contactors				
	DILM115/150 star contactors				

**DILM...-XRL, DILM...XIP2X
Reversing starter wiring kits**

Main current wiring for reversing combinations

For use with	Part no. Article no.	Price See price list	Std. pack	Notes	Information relevant for export to North America
	DILM7	DILM12-XRL 283108	1 Off  	<ul style="list-style-type: none"> Designed for tool-less plug connection As auxiliary contact DILA-XHIT...use → 38 The following control cables are integrated in addition to electrical interlock: <ul style="list-style-type: none"> Q11: A1 - Q12: 21 Q11: 21 - Q12: A1 Q11: A2 - Q12: A2 	Product Standards IEC/EN 60947-4-1; UL 508; CSA-C22.2 No.14-05; CE marking UL File No. E36332 UL CCN NLRV CSA File No. 012528 CSA Class No. 3211-05 NA Certification UL Listed, CSA certified
	DILM9				
	DILM12				
	DILM17	DILM32-XRL 283109	1 Off  	-	Product Standards IEC/EN 60947-4-1; UL 508; CSA-C22.2 No.14-05; CE marking UL File No. E36332 UL CCN NLRV CSA File No. 012528 CSA Class No. 3211-04 NA Certification UL Listed, CSA certified
	DILM25				
	DILM32				
	DILM40	DILM65-XRL 101057	1 Off  	-	Product Standards IEC/EN 60947-4-1; UL 508; CSA-C22.2 No.14-05; CE marking UL File No. E36332 UL CCN NLRV CSA File No. 012528 CSA Class No. 2411-03, 3211-04 NA Certification UL Listed, CSA certified
	DILM50				
	DILM65				
	DILM80	DILM150-XRL 101681	1 Off  	-	Product Standards IEC/EN 60947-4-1; UL 508; CSA-C22.2 No.14-05; CE marking UL File No. E36332 UL CCN NLRV CSA File No. 012528 CSA Class No. 2411-03, 3211-04 NA Certification UL Listed, CSA certified
	DILM95				
	DILM115				
	DILM150				

**DILM...-XRL, DILM...XIP2X
IP2X cover set**

For use with	Part no. Article no.	Price See price list	Std. pack	Notes	Information relevant for export to North America
	DILM17	DILM32-XIP2X 118855	1 Off  	Each cover set consists of two three-pole and two single-pole covers.	UL/CSA certification not required
	DILM25				
	DILM32				
	DILM38				
	DILMP32				
	DILMP45				
	DILM40	DILM65-XIP2X 106491	8 Off  	2 covers are required per phase The cover set consists of 8 covers	UL/CSA certification not required
	DILM50				
	DILM65				
	DILM72				
	DILMP63				
	DILMP80				
	DILM80	DILM150-XIP2X 106492	8 Off  		UL/CSA certification not required
	DILM95				
	DILM115				
	DILM150				
	DILM170				
	DILMP125				
	DILMP160				
	DILMP200				
	ZB150				

1

DILM12-XDSBS Three-phase commoning links

Protected against accidental contact, short-circuit proof, $U_e = 690\text{ V}$, $I_u = 35\text{ A}$ Can be extended by rotating by mounting

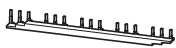

For use with	Part no. Article no.	Price See price list	Std. pack	Notes	Information relevant for export to North America
DILM7 DILM9 DILM12 DILM15	DILM12-XDSB0/3 240084		5 Off 	Suitable for 3 contactors. Length 112 mm	Product Standards IEC/EN 60947-4-1; UL 508; CSA-C22.2 No.14-05; CE marking UL File No. E36332 UL CCN NLRV CSA File No. 012528 CSA Class No. 2411-03 NA Certification UL Listed, CSA certified
DILM7 DILM9 DILM12 DILM15	DILM12-XDSB0/4 240085		5 Off 	Suitable for 4 contactors. Length 157 mm	
DILM7 DILM9 DILM12 DILM15	DILM12-XDSB0/5 240086		5 Off 	Suitable for 5 contactors. Length 202 mm	

DILM12-XDSBS Incoming connection block

For use with	Part no. Article no.	Price See price list	Std. pack	Notes	Information relevant for export to North America
DILM7 DILM9 DILM12 DILM15	DILM12-XEK 240083		5 Off 	For three-phase commoning link, protected against accidental contact, $U_e = 690\text{ V}$, $I_u = 35\text{ A}$. Terminal capacities: Stranded 2.5...16 mm ² Flexible with ferrule 2.5...16 mm ² AWG14...8	Product Standards IEC/EN 60947-4-1; UL 508; CSA-C22.2 No.14-05; CE marking UL File No. E36332 UL CCN NLRV CSA File No. 012528 CSA Class No. 2411-03 NA Certification UL Listed, CSA certified

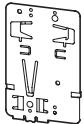

DILM12-XDSBS Adapter plate

Enables clipping on of switches on to DIN rails

For use with	Part no. Article no.	Price See price list	Std. pack	Notes	Information relevant for export to North America
DILM80 DILM95 DILM115 DILM150 DILM170	NZM2-XC75 260215		1 Off 	For top-hat rail 75 mm	Product Standards IEC/EN 60947-4-1; UL 489; CSA-C22.2 No.14-05; CE marking UL File No. E140305 UL CCN DIHS CSA File No. 022086 CSA Class No. 1437-01 NA Certification UL Listed, CSA certified

DILM32-XTE
Electronic timer modules

On-delayed, Cannot be combined with top mounting auxiliary contacts Incl. suppressor circuits

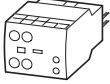

Off-delayed, auxiliary voltage-free Cannot be combined with top mounting auxiliary contacts Incl. suppressor circuits

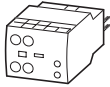

For star-delta applications Cannot be combined with top mounting auxiliary contacts Incl. suppressor circuits

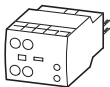

	For use with	Circuit symbol	Part no. Article no.	Price See price list	Std. pack	Notes	
24 V AC/DC	DILM7 - DILM32		DILM32-XTEE11(RA24) 101440		1 Off	Time range can be selected	
100 ... 130 V AC	DILMP20 DILMP32-DILMP45 DILA		DILM32-XTEE11(RAC130) 101441		1 Off	0.05 s...1 s 0.5 s...10 s 5 s...100 s	
200 ... 240 V AC			DILM32-XTEE11(RAC240) 101442		1 Off		
24 V AC/DC	DILM7 - DILM32		DILM32-XTED11-1(RA24) 105210		1 Off	Time range 0.05 s...1 s	
24 V AC/DC	DILMP20 DILMP32-DILMP45 DILA		DILM32-XTED11-10(RA24) 104943		1 Off	Time range 0.5 s...10 s	
24 V AC/DC			DILM32-XTED11-100(RA24) 104946		1 Off	Time range 5 s...100 s	
100 ... 130 V AC			DILM32-XTED11-1(RAC130) 105211		1 Off	Time range 0.05 s...1 s	
100 ... 130 V AC			DILM32-XTED11-10(RAC130) 104944		1 Off	Time range 0.5 s...10 s	
100 ... 130 V AC			DILM32-XTED11-100(RAC130) 104947		1 Off	Time range 5 s...100 s	
200 ... 240 V AC			DILM32-XTED11-1(RAC240) 105212		1 Off	Time range 0.05 s...1 s	
200 ... 240 V AC			DILM32-XTED11-10(RAC240) 104945		1 Off	Time range 0.5 s...10 s	
200 ... 240 V AC			DILM32-XTED11-100(RAC240) 104948		1 Off	Time range 5 s...100 s	
24 V AC/DC	DILM7 - DILM32			DILM32-XTEY20(RA24) 101446		1 Off	Changeover time 1...30 s
100 ... 130 V AC	DILMP20 DILMP32-DILMP45 DILA			DILM32-XTEY20(RAC130) 101447		1 Off	50 ms changeover delay
200 ... 240 V AC				DILM32-XTEY20(RAC240) 101448		1 Off	Sample circuit → Page 92

Information relevant for export to North America



Product Standards	IEC/EN 60947-4-1; UL 508; CSA-C22.2 No.14-05; CE marking
UL File No.	E29184
UL CCN	NKCR
CSA File No.	012528
CSA Class No.	3211-03
NA Certification	UL Listed, CSA certified

1.2 Contactor relays, contactors



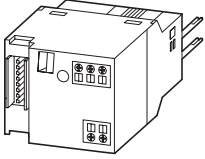

Accessories

1









DIL-SWD..., DILM12-XMC SWD contactor modules

SmartWire-DT® module for installation on contactors. One module per contactor

	For use with	Part no. Article no.	Price See price list	Std. pack	Notes
Two digital inputs for potential-free contacts. 1 electrical interlock for the surface mounting of reversing starters. Messages: Contactor switch status, status of the digital inputs 1 and 2. Commands: Contactor actuation	DILM(C)7... - DILM(C)32 DILM38 DILA	DIL-SWD-32-001¹⁾ 118560		5 Off  	<ul style="list-style-type: none"> Take into account the max. current consumption of the contactor coils per SmartWire-DT® line. A2 terminals must not be bridged. Wiring sets DILM 12-XRL and PKZM0-XRM12 cannot be used. Connection terminals for electrical interlocking are not suitable for safety technology.
Two digital inputs for potential-free contacts. 1 electrical interlock for the surface mounting of reversing starters. 1-0-A switch for manual or automatic operation. Messages: contactor switching position, status of the digital inputs 1 and 2, 1-0-A switch position. Commands: Contactor actuation	DILM(C)7... - DILM(C)32 DILM38 DILA	DIL-SWD-32-002¹⁾ 118561		5 Off  	

DIL-SWD..., DILM12-XMC Wiring set for motor feeder plug

For use with	Part no. Article no.	Price See price list	Std. pack	Notes
DILM(C)7 DILM(C)9 DILM(C)12 DILM(C)15	DILM12-XMCE²⁾ 121764		5 Off  	35x7.5 (15) mm mounting rail (as per DIN EN 60715) with PE function required. For connection of: PE 0.75 – 4 mm ²
DILM(C)7 DILM(C)9 DILM(C)12 DILM(C)15	DILM12-XMCP/E²⁾ 121769		1 Off  	35x7.5 (15) mm mounting rail (as per DIN EN 60715) with PE function required. For connection of: L1, L2, L3, PE 0.75 – 2.5 mm ²
PKZM0/PKE + DILM(C)7 PKZM0/PKE + DILM(C)9 PKZM0/PKE + DILM(C)12 PKZM0/PKE + DILM(C)15 MSC-D(E)-...-M7... MSC-D(E)-...-M9... MSC-D(E)-...-M15...	DILM12-XMCP/T²⁾ 121770		1 Off  	For connection of: L1, L2, L3, PE 0.75 – 2.5 mm ²

PE module with contact plate

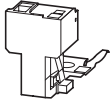

Motor plate with PE module and contact plate

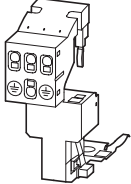

Motor plate with PE module and contact plate









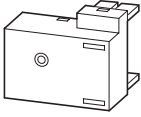

Information relevant for export to North America

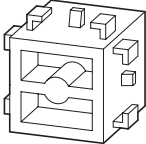

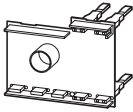
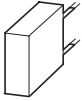
- | | |
|--|---|
| 1) NA Certification | Request filed for UL and CSA |
| 2) Product Standards
NA Certification | IEC/EN 60947-4-1; UL 508; CSA-C22.2 No. 14-05; CE marking
Request filed for UL and CSA |

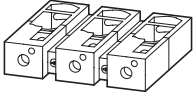
DILM...-X...

	For use with	Part no. Article no.	Price See price list	Std. pack	Notes	Information relevant for export to North America 	
Motor suppressor module							
Can be used at 380...575 V 50/60 Hz.							
	DILM7 - DILM15	DILM12-XMSM 109399		4 Off 	<ul style="list-style-type: none"> • Tool-less version using tool-less plug connection • RC suppressor • Ambient temperature -25...+60 °C, open. • Insulated material, difficult to ignite according to UL 94. • Weight = 0.05 kg. • UL/CSA approval applied for 	Product Standards UL File No. UL CCN NA Certification	IEC/EN 60947-4-1; UL 508; CE marking E300273 NMTR2 UL Listed
Test block							
Suitable for switching on contactor off-load							
	DILM7 - DILM38 DILA	DILM32-XMAN 110955		1 Off 	–	UL/CSA certification not required	
Printed board contact							
For the adaption of a control circuit on a printed-circuit board							
	DILM7 - DILM15 DILA	DILM12-XPBC 109400		4 Off	–	–	
Load resistor							
For DC contactors in order to increase power consumption							
	DILM17 DILM25 DILM32 DILM38 DILMP32 DILMP45	DILM32-XSPLW24 112419		1 Off 	Installed in a suppressor circuit enclosure. Required when using special PLC outputs for actuation, e.g.: Beckhoff safety controllers.	Product Standards CSA File No. CSA Class No. NA Certification	IEC/EN 60947-4-1; CSA-C22.2 No.14-05; CE marking 225135 3211-07 CSA certified
Extension terminals							
	DILM80 DILM95 DILM115 DILM150 DILM170	DILM150-XZK 104486		10 Off 	Can be fitted on every main terminal of the contactor. Connection options: maximum 2 x 4 mm ² solid maximum 2 x 2.5 mm ² flexible with ferrule	Product Standards UL File No. UL CCN CSA File No. CSA Class No. NA Certification	IEC/EN 60947-4-1; UL 508; CSA-C22.2 No.14-05;CE marking E29184 NKCR 012528 2411-03, 2411-04 UL Listed, CSA certified
Cable terminal block							
With control circuit terminal Consisting of three flat ribbon terminals							
	DILM250 DILM300A DILM400	DILM400-XKU-S 208293		1 Off 	Connection options: round conductors, flexible and stranded, ribbon cables.	Product Standards UL File No. UL CCN CSA File No. CSA Class No. NA Certification	IEC/EN 60947-4-1; UL 508; CSA-C22.2 No.14-05;CE marking E29184 NKCR 012528 3211-04 UL Listed, CSA certified

1.2

Contactors relays, contactors

Accessories



1

DILM...-XK...

Flat strip conductor terminal kit

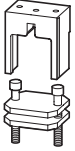
With control cable connection









For use with	Part no. Article no.	Price See price list	Std. pack	Notes	Information relevant for export to North America  
DILM580 DILM650 DILM750 DILM820	DILM820-XKB-S 208295		1 Off	Connection options: ribbon cables	













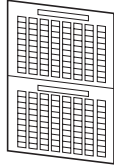

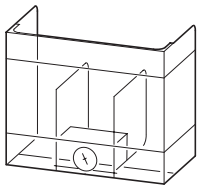

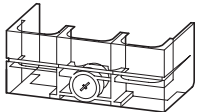

DILM...-XK...

Connection terminal sets for North America

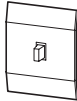
Consist of three individual terminals

Conductor material	Cross-section X number of cores mm ²	For use with	Part no. Article no.	Price See price list	Std. pack	Notes	Information relevant for export to North America  
Copper, aluminum	2 x (AWG4 ... MCM500)	DILM500/22	DILM500-XK-CNA 232192		1 Off  	Including cover With control cable connec- tion	Product Standards IEC/EN 60947-4-1; UL 508; CSA-C22.2 No.14-05; CE marking E29184 NKCR
Copper, aluminum	4 x (AWG2 ... MCM500)	DILM580/22 DILM650/22 DILM750/22 DILM820/22	DILM820-XK-CNA 232194		1 Off  		UL File No. UL CCN CSA File No. CSA Class No. NA Certification 012528 3211-04 UL Listed, CSA certified

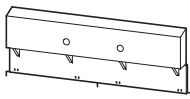
DILM...-XHB, DILM...-XAB

Description	For use with	Part no. Article no.	Price See price list	Std. pack	Notes	Information relevant for export to North America 
Sealable shrouds						
Transparent						
	DILM32-XTE...	DILM32-XTEPLH 101449		1 Off	-	-
Device labelling, label sheet						
7.5 x 17 mm Colour: yellow HKS 3 (≈ RAL 1018)						
	Labelling with laser printer, plotter, film plotter, copier	XGKE-GE 207517		25 Off 	1 off = 1 sheet 240 labels per sheet 1 sheet = DIN A4, Can be split into two DIN A5 sheets	UL/CSA certification not required
Covers						
Terminal cover						
	DILM185A DILM225A	DILM225A-XHB 139560		1 Off 	To provide terminals with protection against accidental contact vertical from the front	UL/CSA certification not required
	DILM250 DILM300A DILM400	DILM400-XHB 208287		1 Off 		
	DILM500	DILM500-XHB 208286		1 Off 		
	DILM580 DILM650	DILM650-XHB 208285		1 Off 		
	DILM750 DILM820, DILM1000	DILM820-XHB 208284		1 Off 		
	Shroud for star-point bridge					
	DILM400-XS1	DILM400-XHBS1 101687		1 Off 	Can be combined with star-delta wiring kits DILM250-XSL and DILM400-XSL.	UL/CSA certification not required
Auxiliary contact seat cover						
	DILM7 - DILM38 DILMP32 DILMP45 DILA DILL	DILM32-XAB 129538		10 Off 	For preventing manual actuation. Cannot be combined with additional surface mounting accessories	UL/CSA certification not required
	DILM40 - DILM170 DILMP63 - DILMP200	DILM150-XAB 121712		10 Off 		
Suppressor circuits for vacuum contactors (on load side)						
	DILM580 DILM650 DILM750 DILM820 DILM1000	DILM1000-XSM 125947		1 Off 	For damping the cutout overvoltage when switching off inductive loads.	NA Certification Request filed for UL and CSA
	DILH2000 DILH2200 DILH2600	DILH2600-XSM 125946		1 Off 		

1.2 Contactor relays, contactors

Accessories

1

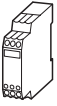

DILM...-XSP... Amplifier module for separate mounting

Input with integrated suppressor circuit for overvoltage limitation

Rated operational current		Actuating voltage	Actuating current	Circuit symbol	For use with	Part no. Article no.	Price See price list	Std. pack	Information relevant for export to North America
AC-15	DC								
230 V	400 V	220 V							
I_e	I_e	I_e	U_s	I					
A	A	A	V DC	mA					
2	2	0.03	24	25		ETS4-VS3 083094		1 Off 	Product Standards IEC/EN 60947-4-1; UL 508; CSA-C22.2 No.14-05; CE marking UL File No. E36332 UL CCN NLRV CSA File No. 012528 CSA Class No. 2411-03, 3211-04 NA Certification UL Listed, CSA certified

Notes Contactor coils with rated operational current > 2 A must be actuated via the DILER-G mini contactor relay.
 Rated operational current DC:
 Making and breaking conditions DC-13, time L/R 300ms

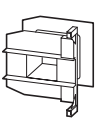

DILM...-XSP... Individual coils

For use with	DC voltage	Part no. Article no.	Prices See price list	AC voltage	Part no. Article no.	Price See price list	Std. pack	Notes
DILM17 DILM25 DILM32 DILM38		DILM32-XSP(RDC24)¹⁾ 281155		DILM32-XSP(230V50Hz,240V60Hz) 281141			1 Off 	For additional actuating voltages → Page 75
DILM40 DILM50 DILM65 DILM72		DILM65-XSP(RDC24)¹⁾ 281185		DILM65-XSP(230V50Hz,240V60Hz) 281171			1 Off 	
DILM80 DILM95		DILM95-XSP(RDC24)¹⁾ 230080		DILM95-XSP(230V50Hz,240V60Hz) 230062			1 Off 	
DILM115 DILM150 DILM170		DILM150-XSP(RDC24)¹⁾ 230115		DILM150-XSP(RAC240)¹⁾ 230112			1 Off 	
DILM185A DILM225A		DILM225A-XSP(RDC24)¹⁾ 139568		DILM225A-XSP(RAC240)¹⁾ 139565			1 Off 	

Notes ¹⁾ Incl. electronic module

Information relevant for export to North America

	Product Standards	IEC/EN 60947-4-1; UL 508; CSA-C22.2 No.14-05; CE marking
	UL File No.	E29096
	UL CCN	NLDX
	CSA File No.	012528
	CSA Class No.	2411-03, 3211-04
	NA Certification	UL Listed, CSA certified

DILM...-XSP/E...
Electronic modules including coils

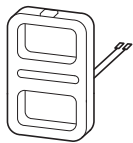
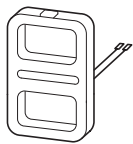

For use with	DC voltage Part no. Article no.	Price See price list	AC voltage Part no. Article no.	Price See price list	Std. pack	Notes
DILM250 DILM300A	DILM250-XSP/E(RA250) ¹⁾ 208252		DILM250-XSP/E(RA250) ¹⁾ 208252		1 Off 	For additional actuating voltages → Page 77
DILM400 DILM500	DILM500-XSP/E(RA250) ¹⁾ 208256		DILM500-XSP/E(RA250) ¹⁾ 208256		1 Off 	
DILM580 DILM650 DILM750 DILM820 DILM1000	DILM1000-XSP/E(RA250) ¹⁾ 289145		DILM1000-XSP/E(RA250) ¹⁾ 289145		1 Off 	
DILH1400	–		DILH1400-XSP/E(RAW250) ²⁾ 289161		1 Off 	
DILM250-S DILM300A-S	–		DILM250-S-XSP/E(220-240V50/60Hz) ²⁾ 274202		1 Off 	
DILM400-S DILM500-S	–		DILM500-S-XSP/E(220-240V50/60Hz) ²⁾ 274205		1 Off 	

1)

Information relevant for export to North America



Product Standards	IEC/EN 60947-4-1; UL 508; CSA-C22.2 No.14-05; CE marking
UL File No.	E29096
UL CCN	NLDX
CSA File No.	1017510
CSA Class No.	3211-04
NA Certification	UL Listed, CSA certified

2)

Information relevant for export to North America



Product Standards	IEC/EN 60947-4-1; UL 508; CSA-C22.2 No.14-05; CE marking
UL File No.	E29096
UL CCN	NLDX
CSA File No.	012528
CSA Class No.	3211-04
NA Certification	UL Listed, CSA certified

1.2 Contactor monitoring devices

1 Description, ordering



General

For safety-related off switching to safety category 3 and 4 according to EN 954-1, at present two contactors must be used in series. Especially with larger contactors this is an expensive solution.

Application

This is where the CMD can be used. The function of the CMD is to monitor the main contacts of a contactor against welding. For this the control voltage of the contactor is compared with the state of the main contacts which is reliably monitored using a mirror contact (IEC EN 60947-4-1 Annex F). If the coil is de-energized and the contactor does not drop out the CMD trips the upstream circuit-breaker/motor protective circuit breaker/switch-disconnector via a shunt release.

Safety

The CMD has a safety-compliant design so that in safety combinations with a circuit-breaker/motor protective circuit breaker/switch-disconnector the reliable switch off in the case of a "welded contactor" can be guaranteed. In this application it replaces the series connection of a second contactor. As a component it conforms to safety category 3 according to EN 954-1 and EN ISO 13849.

Mounting

The CMD can be combined with the following Eaton components:

- Contactors:
 - DILEM
 - DILM7 to DILM150
 - DILM185(-S) to DILM500(-S);
 - DILM580 to DILM1600
 - DILH1400 ... DILH2000
 - SE-1A-PKZ2 and S-PKZ2
- Motor-protective circuit-breakers/circuit-breakers:
 - PKZ2 + U-PKZ2(18VDC)
 - NZM1 + NZM1-XUVL
 - NZM2 + NZM2/3-XUV
 - NZM3 + NZM2/3-XUV
 - NZM4 + NZM4-XUV
 - N1 + NZM1-XUVL
 - N2 + NZM2/3-XUV
 - N3 + NZM2/3-XUV
 - N4 + NZM4-XUV

For the wiring of the CMD the auxiliary N/C contact, mirror contact must be according to IEC/EN 60947-4-1 and the auxiliary N/O contact must be interlocked and opposing according to IEC/EN 60947-5-1. Also the auxiliary N/C contact for the feedback circuit must have a mirror contact function according to IEC/EN 60947-4-1.

Auxiliary contact requirements per contactor:

	CMD	Self maintaining	Feedback circuit	Electrical interlock
DOL starter	1 N/O + 1 N/C	1S	1 B	
Reversing starter	1 N/O + 1 N/C	1S	1 B	1 B

Ordering

CMD contactor monitoring device

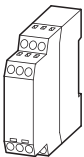

CMD

Part no. Article no.	Price See Price List	Std. pack
CMD(24VDC) 106170		1 Off
CMD(220-240VAC) 106172		1 Off

Engineering

DOL starter

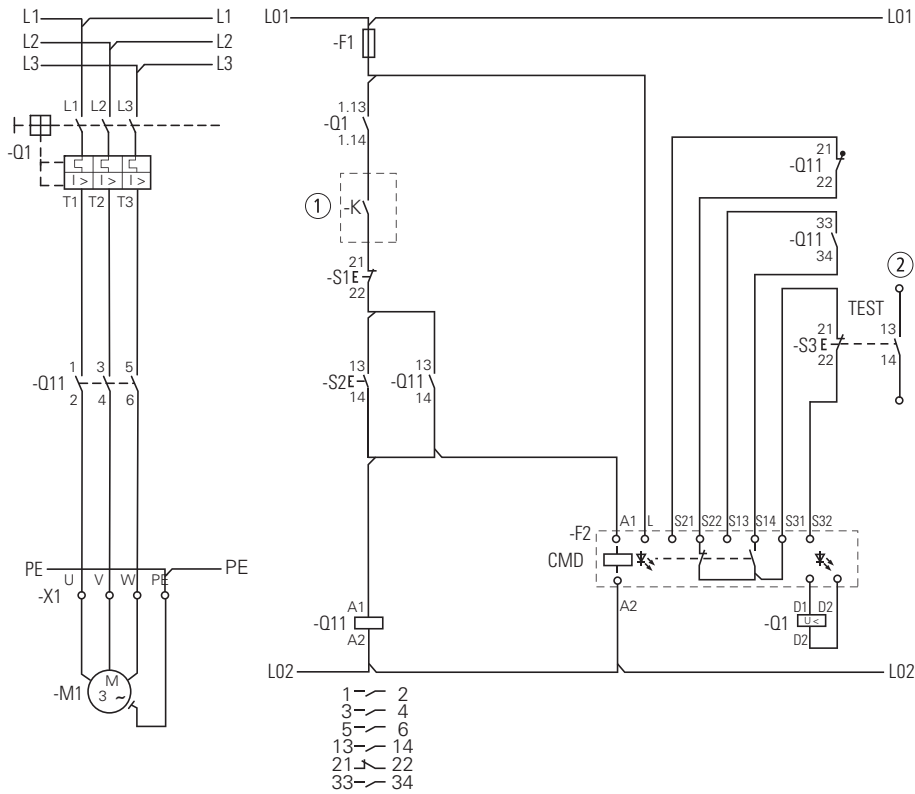

Reversing starter

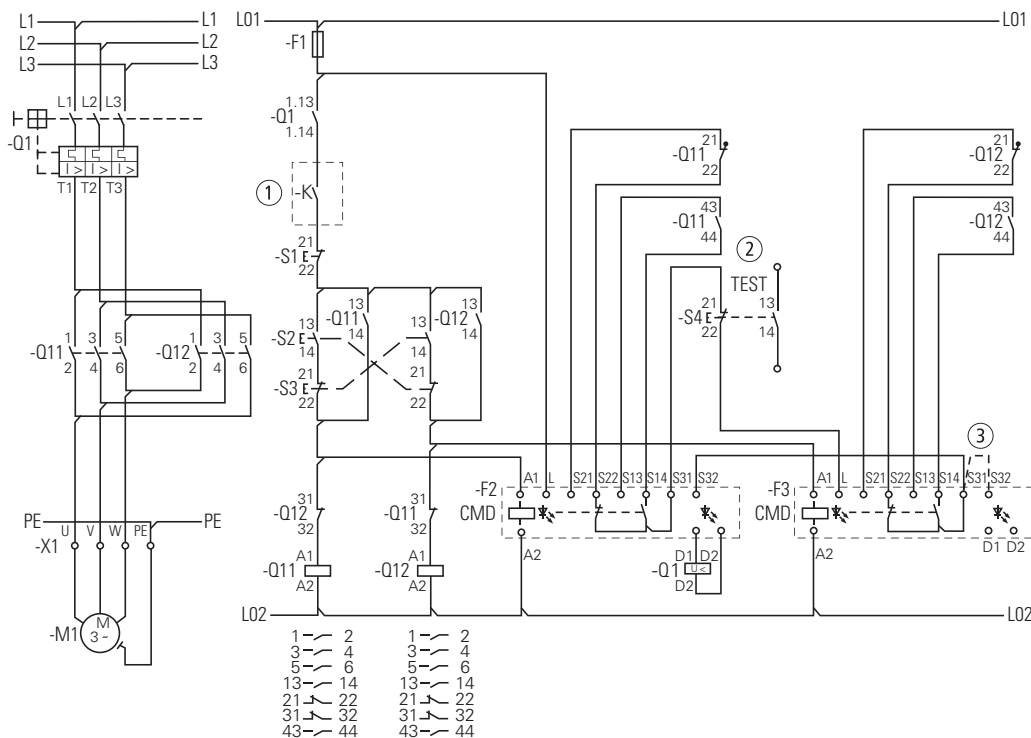

- ① Switching by safety relay of safety PLC
- ② Signal contact to PLC evaluation
- ③ CMD (24VDC)

1.2

Mini contactor relays, contactor relays

Actuating voltages

1 Ordering

DILER, DILEEM

AC	DILER-40(...)	DILER-31(...)	DILER-22(...)	DILEEM-10(...)	DILEEM-01(...)
	Article no. ¹⁾	Article no. ¹⁾	Article no. ¹⁾	Article no. ¹⁾	Article no. ¹⁾
Standard voltages	See price list	See price list	See price list	See price list	See price list
24V 50Hz	010094	010251	010344	051604	051629
48V 50Hz	010190	010044	010201	051603	051628
240V 50Hz	010478	010300	010138	051602	051627
115V 60Hz	010270	010204	010211	051598	051624
42V 50Hz, 48V 60Hz	–	–	–	051612	051637
110V 50Hz, 120V 60Hz	051756	051765	051774	051611	051636
190V 50Hz, 220V 60Hz	051757	051766	051775	051610	051635
220V 50Hz, 240V 60Hz	051758	051767	051776	051609	051634
230V 50Hz, 240V 60Hz	051759	051768	051777	051608	051633
380V 50Hz, 440V 60Hz	051760	051769	051778	051607	051632
400V 50Hz, 440V 60Hz	051761	051770	051779	051606	051631
415V 50Hz, 480V 60Hz	051762	051771	051780	051605	051630
24V 50/60Hz	021924	021594	021704	051596	051621
42V 50/60Hz	033459	029869	029433	051595	051620
110V 50/60Hz	021961	021624	021871	051592	051618
230V 50/60Hz	052725	052509	052508	056674	058771

DILER, DILEEM

DC	DILER-40-G(...)	DILER-31-G(...)	DILER-22-G(...)	DILEEM-10-G(...)	DILEEM-01-G(...)
	Article no. ¹⁾	Article no. ¹⁾	Article no. ¹⁾	Article no. ¹⁾	Article no. ¹⁾
Standard voltages	See price list	See price list	See price list	See price list	See price list
12V DC	079711	079761	080728	051644	051649
24V DC	010223	010157	010042	051643	051650
48V DC	010255	010205	010346	051642	051648
110V DC	010287	010253	010043	051640	051646
220V DC	010303	010269	010091	051639	051645

Notes

¹⁾ To obtain the article number for ordering, read under selected part number and actuating voltage from the table.
Devices with dual-voltage coils are to be ordered under a single article number.

DILEM

AC	DILEM-10(...)	DILEM-01(...)	DILEM12-10(...)	DILEM12-01(...)	DILEM4(...)
	Article no. ¹⁾	Article no. ¹⁾	Article no. ¹⁾	Article no. ¹⁾	Article no. ¹⁾
Standard voltages	See price list	See price list	See price list	See price list	See price list
24V 50Hz	010005	010086	127067	127083	014754
48V 50Hz	010020	010294	–	–	–
240V 50Hz	010032	010151	–	–	014305
115V 60Hz	010024	010470	–	–	–
42V 50Hz, 48V 60Hz	051782	051791	–	–	–
110V 50Hz, 120V 60Hz	051783	051792	127072	127088	051801
190V 50Hz, 220V 60Hz	051784	051793	–	–	–
220V 50Hz, 240V 60Hz	051785	051794	–	–	051803
230V 50Hz, 240V 60Hz	051786	051795	–	–	051804
380V 50Hz, 440V 60Hz	051787	051796	–	–	–
400V 50Hz, 440V 60Hz	051788	051797	–	–	051806
415V 50Hz, 480V 60Hz	051789	–	–	–	–
24V 50/60Hz	021417	020402	127079	127095	022044
42V 50/60Hz	032174	033233	–	–	–
110V 50/60Hz	021455	020436	127081	127097	–
230V 50/60Hz	052302	051114	127082	127098	052506

DILEM

DC	DILEM-10-G(...)	DILEM-01-G(...)	DILEM12-10-G(...)	DILEM12-01-G(...)	DILEM4-G(...)
	Article no. ¹⁾	Article no. ¹⁾	Article no. ¹⁾	Article no. ¹⁾	Article no. ¹⁾
Standard voltages	See price list	See price list	See price list	See price list	See price list
12V DC	079594	079642	–	–	079680
24V DC	010213	010343	127132	127137	012701
48V DC	010245	010496	–	–	–
110V DC	010309	010136	–	–	–
220V DC	010325	010168	–	–	–

Notes ¹⁾ To obtain the article number for ordering, read under selected part number and actuating voltage from the table. Devices with **dual-voltage coils** are to be ordered under a **single** article number.

1.2

Contactor relays

Actuating voltages

1 DILA

AC

	With screw terminals			With Spring-loaded terminals		
	DILA-40(...)	DILA-31(...)	DILA-22(...)	DILAC-40(...)	DILAC-31(...)	DILAC-22(...)
	Article no. ¹⁾	Article no. ¹⁾	Article no. ¹⁾	Article no. ¹⁾	Article no. ¹⁾	Article no. ¹⁾
Standard voltages	See price list	See price list	See price list	See price list	See price list	See price list
24V 50Hz	276316	276351	276386	276431	276463	276495
240V 50Hz	276318	276353	276388	–	–	–
110V 50Hz 120V 60Hz	276326	276361	276396	276438	276470	276502
190V 50Hz 220V 60Hz	276327	276362	276397	–	–	–
220V 50Hz 240V 60Hz	276328	276363	276398	–	–	–
230V 50Hz 240V 60Hz	276329	276364	276399	276441	276473	276505
380V 50Hz 440V 60Hz	276330	276365	276400	–	–	–
400V 50Hz 440V 60Hz	276331	276366	276401	–	–	–
24V 50Hz/60Hz	276333	276368	276403	276445	276477	276509
42V 50Hz/60Hz	276334	276369	276404	–	–	–
110V 50Hz/60Hz	276335	276370	276405	–	–	–
220V 50Hz/60Hz	276336	276371	276406	–	–	–
230V 50Hz/60Hz	276337	276372	276407	276449	276481	276513
Special voltages other than the already shown normal voltages ²⁾	See price list	See price list	See price list	See price list	See price list	See price list
...V 50Hz(12-500V)³⁾	276341	276376	276411	276453	276485	276517
...V 60Hz(12-600V)³⁾	276342	276377	276412	276454	276486	276518

DILA

DC

	With screw terminals			With Spring-loaded terminals		
	DILA-40(...)	DILA-31(...)	DILA-22(...)	DILAC-40(...)	DILAC-31(...)	DILAC-22(...)
	Article no. ¹⁾	Article no. ¹⁾	Article no. ¹⁾	Article no. ¹⁾	Article no. ¹⁾	Article no. ¹⁾
Standard voltages	See price list	See price list	See price list	See price list	See price list	See price list
24V DC	276344	276379	276414	276456	276488	276520
48V DC	276345	276380	276415	–	–	–
110V DC	276347	276382	276417	276459	276491	276523
220V DC	276348	276383	276418	276460	276492	276524
Special voltages other than the already shown normal voltages ²⁾	See price list	See price list	See price list	See price list	See price list	See price list
...V DC(12-250V)³⁾	276349	276384	276419	276461	276493	276525

Notes

¹⁾ The article number is a combination of part no. and operating voltage devices with dual-voltage coils can be ordered under a single article no.

²⁾ With non-standard voltages the required actuating voltage from the defined range (...-...V) must be stated.

³⁾ Minimum order quantity 10 units

DILM

AC	DILM7-10 (...)	DILM7-01 (...)	DILM9-10 (...)	DILM9-01 (...)	DILM12-10 (...)	DILM12-01 (...)	DILM15-10 (...)	DILM15-01 (...)
	Article no. ¹⁾	Article no. ¹⁾	Article no. ¹⁾	Article no. ¹⁾	Article no. ¹⁾	Article no. ¹⁾	Article no. ¹⁾	Article no. ¹⁾
Standard voltages	See price list	See price list	See price list	See price list	See price list	See price list	See price list	See price list
24V 50Hz	276537	276572	276677	276712	276817	276852	290045	290080
240V 50Hz	276539	276574	276679	276714	276819	276854	–	–
42V 50Hz 48V 60Hz	276546	–	276686	–	276826	–	–	–
110V 50Hz 120V 60Hz	276547	276582	276687	276722	276827	276862	290055	290090
190V 50Hz 220V 60Hz	276548	276583	276688	276723	276828	276863	–	–
220V 50Hz 240V 60Hz	276549	276584	276689	276724	276829	276864	–	–
230V 50Hz 240V 60Hz	276550	276585	276690	276725	276830	276865	290058	290093
380V 50Hz 440V 60Hz	276551	276586	276691	276726	276831	276866	–	–
400V 50Hz 440V 60Hz	276552	276587	276692	276727	276832	276867	–	–
415V 50Hz 480V 60Hz	276553	–	276693	–	276833	–	–	–
24V 50Hz/60Hz	276554	276589	276694	276729	276834	276869	290062	290097
42V 50Hz/60Hz	276555	276590	276695	276730	276835	276870	–	–
110V 50Hz/60Hz	276556	276591	276696	276731	276836	276871	–	–
220V 50Hz/60Hz	276557	276592	276697	276732	276837	276872	–	–
230V 50Hz/60Hz	276558	276593	276698	276733	276838	276873	290066	290101
Special voltages other than the already shown normal voltages ²⁾	See price list	See price list	See price list	See price list	See price list	See price list	See price list	See price list
...V 50Hz (12 – 600V)³⁾	276562	276597	276702	276737	276842	276877	290070	290105
...V 60Hz (12 – 600V)³⁾	276563	276598	276703	276738	276843	276878	290071	290106

DILM

DC	DILM7-10 (...)	DILM7-01 (...)	DILM9-10 (...)	DILM9-01 (...)	DILM12-10 (...)	DILM12-01 (...)	DILM15-10 (...)	DILM15-01 (...)
	Article no. ¹⁾	Article no. ¹⁾	Article no. ¹⁾	Article no. ¹⁾	Article no. ¹⁾	Article no. ¹⁾	Article no. ¹⁾	Article no. ¹⁾
Standard voltages	See price list	See price list	See price list	See price list	See price list	See price list	See price list	See price list
24V DC	276565	276600	276705	276740	276845	276880	290073	290108
48V DC	276566	276601	276706	276741	276846	276881	–	–
110V DC	276568	276603	276708	276743	276848	276883	–	–
220V DC	276569	276604	276709	276744	276849	276884	–	–
Special voltages other than the already shown normal voltages ²⁾	See price list	See price list	See price list	See price list	See price list	See price list	See price list	See price list
...V DC (12-250V)³⁾	276570	276605	276710	276745	276850	276885	290078	290113

Notes

- ¹⁾ To obtain the article number for ordering, read under selected part number and actuating voltage from the table. devices with dual-voltage coils can be ordered under a single article no.
- ²⁾ With non-standard voltages the required actuating voltage from the defined range (...–...V) must be stated.
- ³⁾ Minimum order quantity 10 units

1 DILM

AC	DILM17-10 (...)	DILM17-01 (...)	DILM25-10 (...)	DILM25-01 (...)	DILM32-10 (...)	DILM32-01 (...)	DILM38-10(...) (...)	DILM38-01(...) (...)
	Article no. ¹⁾	Article no. ¹⁾	Article no. ¹⁾	Article no. ¹⁾	Article no. ¹⁾	Article no. ¹⁾	Article no. ¹⁾	Article no. ¹⁾
Standard voltages	See price list	See price list	See price list	See price list	See price list	See price list	See price list	See price list
24V 50Hz	276991	277023	277119	277151	277247	277279	112378	112446
240V 50Hz	276993	–	277121	–	277249	–	112420	–
42V 50Hz	277000	–	277128	–	277256	–	112424	–
48V 60Hz								
110V 50Hz	277001	277033	277129	277161	277257	277289	112425	112454
120V 60Hz								
190V 50Hz	277002	–	277130	–	277258	–	112426	–
220V 60Hz								
220V 50Hz	277003	–	277131	–	277259	–	112427	–
240V 60Hz								
230V 50Hz	277004	277036	277132	277164	277260	277292	112428	112457
240V 60Hz								
380V 50Hz	277005	–	277133	–	277261	–	112429	–
440V 60Hz								
400V 50Hz	277006	277038	277134	277166	277262	277294	112430	112459
440V 60Hz								
415V 50Hz	277007	–	277135	–	277263	–	112431	–
480V 60Hz								
24V 50Hz/60Hz	277008	277040	277136	277168	277264	277296	112432	112461
42V 50Hz/60Hz	277009	–	277137	–	277265	–	112433	–
110V 50Hz/60Hz	277010	277042	277138	277170	277266	277298	112434	112463
220V 50Hz/60Hz	277011	277043	277139	277171	277267	277299	112435	112464
230V 50Hz/60Hz	277012	277044	277140	277172	277268	277300	112436	112465
Special voltages other than the already shown normal voltages ²⁾	See price list	See price list	See price list	See price list	See price list	See price list	See price list	See price list
...V 50Hz (24 – 600V)	277016 ⁷⁾	277048 ⁷⁾	277144 ⁷⁾	277176 ⁷⁾	277272 ⁷⁾	277304 ⁸⁾	112440 ⁷⁾	112468 ⁷⁾
...V 60Hz (24 – 600V)	277017 ⁷⁾	277049 ⁷⁾	277145 ⁷⁾	277177 ⁷⁾	277273 ⁷⁾	277305 ⁸⁾	112441 ⁷⁾	112469 ⁷⁾

DILM

DC	DILM17-10(...)	DILM17-01(...)	DILM25-10(...)	DILM25-01(...)	DILM32-10(...)	DILM32-01(...)	DILM38-10(...)	DILM38-01(...)
	Article no. ¹⁾	Article no. ¹⁾	Article no. ¹⁾	Article no. ¹⁾	Article no. ¹⁾	Article no. ¹⁾	Article no. ¹⁾	Article no. ¹⁾
Standard voltages	See price list	See price list	See price list	See price list	See price list	See price list	See price list	See price list
RDC 24³⁾	277018	277050	277146	277178	277274	277306	112442	112470
RDC 60⁴⁾	277019	277051	277147	277179	277275	277307	112443	112471
RDC 130⁵⁾	277020	277052	277148	277180	277276	277308	112444	112472
RDC 240⁶⁾	277021	277053	277149	277181	277277	277309	112445	112473

Notes

- ¹⁾ To obtain the article number for ordering, read under selected part number and actuating voltage from the table. devices with dual-voltage coils can be ordered under a single article no.
- ²⁾ With non-standard voltages the required actuating voltage from the defined range (...–...V) must be stated.
- ³⁾ 24 – 27 V DC
- ⁴⁾ 48 – 60 V DC
- ⁵⁾ 110 – 130 V DC
- ⁶⁾ 200 – 240 V DC
- ⁷⁾ Minimum order quantity 10 units
- ⁸⁾ Minimum order quantity 5 units

DILM

AC	DILM40(...)	DILM50(...)	DILM65(...)	DILM72(...)
	Article no. ¹⁾	Article no. ¹⁾	Article no. ¹⁾	Article no. ¹⁾
Standard voltages	See price list	See price list	See price list	See price list
24V 50Hz	277753	277817	277881	–
240V 50Hz	277755	277819	277883	109183
42V 50Hz 48V 60Hz	277762	277826	277890	–
110V 50Hz 120V 60Hz	277763	277827	277891	109191
190V 50Hz 220V 60Hz	277764	277828	277892	–
220V 50Hz 240V 60Hz	277765	277829	277893	–
230V 50Hz 240V 60Hz	277766	277830	277894	107670
380V 50Hz 440V 60Hz	277767	277831	277895	–
400V 50Hz 440V 60Hz	277768	277832	277896	109195
415V 50Hz 480V 60Hz	277769	277833	277897	–
24V 50Hz/60Hz	277770	277834	277898	109197
42V 50Hz/60Hz	277771	277835	277899	–
110V 50Hz/60Hz	277772	277836	277900	109199
220V 50Hz/60Hz	277773	277837	277901	109200
230V 50Hz/60Hz	277774	277838	277902	109201
Special voltages other than the already shown normal voltages ²⁾	See price list	See price list	See price list	See price list
...V 50Hz (24 – 600V)	277778 ⁸⁾	277842 ⁸⁾	277906 ⁸⁾	109205 ⁷⁾
...V 60Hz (24 – 600V)	277779 ⁸⁾	277843 ⁸⁾	277907 ⁸⁾	109206 ⁷⁾

DILM

DC	DILM40(...)	DILM50(...)	DILM65(...)	DILM72(...)
	Article no. ¹⁾	Article no. ¹⁾	Article no. ¹⁾	Article no. ¹⁾
Standard voltages	See price list	See price list	See price list	See price list
RDC 24 ³⁾	277780	277844	277908	107671
RDC 60 ⁴⁾	277781	277845	277909	–
RDC 130 ⁵⁾	277782	277846	277910	–
RDC 240 ⁶⁾	277783	277847	277911	109209

Notes

- 1) To obtain the article number for ordering, read under selected part number and actuating voltage from the table.
devices with dual-voltage coils can be ordered under a single article no.
- 2) With non-standard voltages the required actuating voltage from the defined range (...–...V) must be stated.
- 3) 24 – 27 V DC
- 4) 48 – 60 V DC
- 5) 110 – 130 V DC
- 6) 200 – 240 V DC
- 7) Minimum order quantity 10 units

1.2

Contactors Actuating voltages

1 DILM

AC	DILM80 (...)	DILM95 (...)
	Article no. ¹⁾	Article no. ¹⁾
Standard voltages	See price list	See price list
24 V 50 Hz	235904	239467
240V 50Hz	235910	239469
42V 50Hz 48V 60Hz	239394	239476
110V 50Hz 120V 60Hz	239399	239477
190V 50Hz 220V 60Hz	239400	239478
220V 50Hz 240V 60Hz	239401	239479
230V 50Hz 240V 60Hz	239402	239480
380V 50Hz 440V 60Hz	239403	239481
400V 50Hz 440V 60Hz	239404	239482
415V 50Hz 480V 60Hz	239405	239483
24V 50Hz/60Hz	239406	239484
42V 50Hz/60Hz	239407	239485
110V 50Hz/60Hz	239408	239486
220V 50Hz/60Hz	239409	239487
230V 50Hz/60Hz	239410	239488
Special voltages other than the already shown normal voltages ²⁾	See price list	list
...V 50Hz (24 – 600V) ¹³⁾	239414	239504
...V 60Hz (24 – 600V) ¹³⁾	239415	239509

DILM

DC	DILM80 (...)	DILM95 (...)
	Article no. ¹⁾	Article no. ¹⁾
Standard voltages	See price list	See price list
RDC 24³⁾	239416	239510
RDC 60⁴⁾	239417	239511
RDC 130⁵⁾	239418	239512
RDC 240⁶⁾	239419	239513

DILM

AC	DILM115 (...)	DILM150 (...)	DILM170 (...)	DILM185A/ 22(...)	DILM225A/ 22(...)
	Article no. ¹⁾	Article no. ¹⁾	Article no. ¹⁾	Article no. ¹⁾	Article no. ¹⁾
Standard voltages	See price list	See price list	See price list	See price list	See price list
RAC 24⁷⁾	239545	239585	107010	139534	139544
RAC 48⁸⁾	239546	239586	107011	139535	139545
RAC 120⁹⁾	239547	239587	107012	139536	139546
RAC 240¹⁰⁾	239548	239588	107013	139537	139547
RAC 440¹¹⁾	239549	239589	107014	139538	139548
RAC 500¹²⁾	239550	239590	107015	139539	139549

DILM

DC	DILM115 (...)	DILM150 (...)	DILM170 (...)	DILM185A/ 22(...)	DILM225A/ 22(...)
	Article no. ¹⁾	Article no. ¹⁾	Article no. ¹⁾	Article no. ¹⁾	Article no. ¹⁾
Standard voltages	See price list	See price list	See price list	See price list	See price list
RDC 24³⁾	239555	239591	107016	139540	139550
RDC 60⁴⁾	239560	239592	107017	139541	139551
RDC 130⁵⁾	239567	239593	107018	139542	139552
RDC 240⁶⁾	239572	239594	107019	139543	139553

Notes

- ¹⁾ The article no. results from combining the part no. and the actuating voltage. Devices with dual-voltage coils must be ordered under a single article no.
- ²⁾ With non-standard voltages the required actuating voltage from the defined range (...-...V) must be stated.
- ³⁾ 24 - 27 V DC
- ⁴⁾ 48 – 60 V DC
- ⁵⁾ 110 - 130 V DC
- ⁶⁾ 200 - 240 V DC
- ⁷⁾ 24 V 50/60 Hz
- ⁸⁾ 42 – 48 V 50/60 Hz
- ⁹⁾ 100 – 120 V 50/60 Hz
- ¹⁰⁾ 190 – 240 V 50/60 Hz
- ¹¹⁾ 380 – 440 V 50/60 Hz
- ¹²⁾ 480 – 500 V 50/60 Hz
- ¹³⁾ Minimum order quantity 5 units

DILM

AC	DILMC7-10 (...)	DILMC7-01 (...)	DILMC9-10 (...)	DILMC9-01 (...)	DILMC12-10 (...)	DILMC12-01 (...)	DILMC15-10 (...)	DILMC15-01 (...)
	Article no. ¹⁾	Article no. ¹⁾	Article no. ¹⁾	Article no. ¹⁾	Article no. ¹⁾	Article no. ¹⁾	Article no. ¹⁾	Article no. ¹⁾
Standard voltages	See price list	See price list	See price list	See price list	See price list	See price list	See price list	See price list
24 V 50 Hz	277379	277411	277443	277475	277507	277539	293938	293933
110V 50Hz 120V 60Hz	277386	277418	277450	277482	277514	277546	293908	293943
230V 50Hz 240V 60Hz	277389	277421	277453	277485	277517	277549	293911	293946
24V 50Hz/60Hz	277393	277425	277457	277489	277521	277553	293915	293950
230V 50Hz/60Hz	277397	277429	277461	277493	277525	277557	293919	293954
Special voltages other than the already shown normal voltages ²⁾	See price list	See price list	See price list	See price list	See price list	See price list	See price list	See price list
...V 50Hz (12 – 600V)⁶⁾	277401	277433	277465	277497	277529	277561	293923	293958
...V 60Hz (12 – 600V)⁶⁾	277402	277434	277466	277498	277530	277562	293924	293959

DILM

DC	DILMC7-10 (...)	DILMC7-01 (...)	DILMC9-10 (...)	DILMC9-01 (...)	DILMC12-10 (...)	DILMC12-01 (...)	DILMC15-10 (...)	DILMC15-01 (...)
	Article no. ¹⁾	Article no. ¹⁾	Article no. ¹⁾	Article no. ¹⁾	Article no. ¹⁾	Article no. ¹⁾	Article no. ¹⁾	Article no. ¹⁾
Standard voltages	See price list	See price list	See price list	See price list	See price list	See price list	See price list	See price list
24V DC	277404	277436	277468	277500	277532	277564	293926	293961
110V DC	277407	277439	277471	277503	277535	277567	293929	293964
220V DC	277408	277440	277472	277504	277536	277568	293930	293965
Special voltages other than the already shown normal voltages ²⁾	See price list	See price list	See price list	See price list	See price list	See price list	See price list	See price list
...VDC (12 – 250V)⁶⁾	277409	277441	277473	277505	277537	277569	293931	293966

DILM

AC	DILMC17-10 (...)	DILMC17-01(...)	DILMC25-10 (...)	DILMC25-01 (...)	DILMC32-10 (...)	DILMC32-01 (...)
	Article no. ¹⁾	Article no. ¹⁾	Article no. ¹⁾	Article no. ¹⁾	Article no. ¹⁾	Article no. ¹⁾
Standard voltages	See price list	See price list	See price list	See price list	See price list	See price list
24 V 50 Hz	277570	277600	277630	277660	277690	277720
110V 50Hz 120V 60Hz	277578	277608	277638	277668	277698	277728
230V 50Hz 240V 60Hz	277581	277611	277641	277671	277701	277731
24V 50Hz/60Hz	277585	277615	277645	277675	277705	277735
220V 50Hz/60Hz	277588	277618	277648	277678	277708	277738
230V 50Hz/60Hz	277589	277619	277649	277679	277709	277739
Special voltages other than the already shown normal voltages ²⁾	See price list	See price list	See price list	See price list	See price list	See price list
...V 50Hz (24 – 600V)⁶⁾	277593	277623	277653	277683	277713	277743
...V 60Hz (24 – 600V)⁶⁾	277594	277624	277654	277684	277714	277744

DILM

DC	DILMC17-10 (...)	DILMC17-01 (...)	DILMC25-10 (...)	DILMC25-01 (...)	DILMC32-10 (...)	DILMC32-01 (...)
	Article no. ¹⁾	Article no. ¹⁾	Article no. ¹⁾	Article no. ¹⁾	Article no. ¹⁾	Article no. ¹⁾
Standard voltages	See price list	See price list	See price list	See price list	See price list	See price list
RDC 24³⁾	277595	277625	277655	277685	277715	277745
RDC 130⁴⁾	277597	277627	277657	277687	277717	277747
RDC 240⁵⁾	277598	277628	277658	277688	277718	277748

Notes

- ¹⁾ The article no. results from combining the part no. and the actuating voltage. Devices with dual-voltage coils must be ordered under a single article no.
- ²⁾ With non-standard voltages the required actuating voltage from the defined range (...-...V) must be stated.
- ³⁾ 24 - 27 V DC
- ⁴⁾ 110 - 130 V DC
- ⁵⁾ 200 - 240 V DC
- ⁶⁾ Minimum order quantity 10 units

1.2

Contactors Actuating voltages

1 DILMP20

AC	DILMP20 (...)	AC	DILMP20 (...)	AC	DILMP20 (...)
	Article no. ¹⁾		Article no. ¹⁾		Article no. ¹⁾
Standard voltages	See price list	Standard voltages	See price list	Non-standard voltages ²⁾	See price list
240V 50Hz	–	RAC 24⁴⁾	–	...V 50Hz (12 – 600V)³⁾	276982
110V 50Hz	276967	RAC 120⁵⁾	–	...V 60Hz (12 – 600V)³⁾	276983
120V 60Hz	–	RAC 240⁶⁾	–		
230 V 50Hz	276970				
240V 60Hz	–				
24V 50/60Hz	276974				
230V 50/60Hz	276978				

DILMP20

DC	DILMP20 (...)	DC	DILMP20 (...)
	Article no. ¹⁾		Article no. ¹⁾
Standard voltages	See price list	Non-standard voltages ²⁾	See price list
24V DC	276985	...V DC (12 – 250V)³⁾	276990
RDC 24⁷⁾	–		

Notes

- 1) The article number is a combination of part no. and actuating voltage
- 2) For non-standard voltages, state the actuating voltage selected from the range (...–...V) shown.
- 3) Minimum order quantity: 10 units
- 4) 24 V 50/60 Hz
- 5) 100 – 120 V 50/60 Hz
- 6) 190 – 240 V 50/60 Hz
- 7) 24 – 27 V DC

DILM...XSP...

AC	DILM32-XSP (...)	DILM65-XSP (...)	DILM95- XSP
	Article no. ¹⁾	Article no. ¹⁾	Article no. ¹⁾
Standard voltages	See price list	See price list	See price list
24V 50Hz	281130	281160	229984
240V 50Hz	281132	281162	229986
24V 60Hz	281134	281164	229988
115V 60Hz	281136	281166	229990
42V 50Hz 48V 60Hz	281137	281167	229994
110V 50Hz 120V 60Hz	281138	281168	230058
190V 50Hz 220V 60Hz	281139	281169	230059
220V 50Hz 240V 60Hz	281140	281170	230061
230V 50Hz 240V 60Hz	281141	281171	230062
380V 50Hz 440V 60Hz	281142	281172	230063
400V 50Hz 440V 60Hz	281143	281173	230064
415V 50Hz 480V 60Hz	281144	281174	230065
24V 50Hz/60Hz	281145	281175	230066
42V 50Hz/60Hz	281146	281176	230067
110V 50Hz/60Hz	281147	281177	230068
220V 50Hz/60Hz	281148	281178	230073
230V 50Hz/60Hz	281149	281179	230074
Special voltages other than the already shown normal-voltages ²⁾	See price list	See price list	See price list
...V 50Hz (24 – 600V)	281153 ¹³⁾	281183 ¹⁴⁾	230078 ¹⁴⁾
...V 60Hz (24 – 600V)	281154 ¹³⁾	281184 ¹⁴⁾	230079 ¹⁴⁾

DILM...XSP...

DC	DILM32-XSP (...)	DILM65-XSP (...)	DILM95- XSP
	Article no. ¹⁾	Article no. ¹⁾	Article no. ¹⁾
Standard voltages	See price list	See price list	See price list
RDC 24³⁾	281155	281185	230080
RDC 60⁴⁾	281156	281186	230081
RDC 130⁵⁾	281157	281187	230082
RDC 240⁶⁾	281158	281188	230107

DILM...XSP...

AC	DILM150-XSP (...)	DILM225A-XSP (...)
	Article no. ¹⁾	Article no. ¹⁾
Standard voltages	See price list	See price list
RAC 24⁷⁾	230109	139562
RAC 48⁸⁾	230110	139563
RAC 120⁹⁾	230111	139564
RAC 240¹⁰⁾	230112	139565
RAC 440¹¹⁾	230113	139566
RAC 500¹²⁾	230114	139567

DILM...XSP...

DC	DILM150-XSP (...)	DILM225A-XSP (...)
	Article no. ¹⁾	Article no. ¹⁾
Standard voltages	See price list	See price list
RDC 24³⁾	230115	139568
RDC 60⁴⁾	230116	139569
RDC 130⁵⁾	230117	139570
RDC 240⁶⁾	230122	139571

Notes

- 1) To obtain the article number for ordering, read under selected part number and actuating voltage from the table.
Devices with dual-voltage coils are to be ordered under a single article number.
- 2) With non-standard voltages the required actuating voltage from the defined range (...–...V) must be stated.
- 3) 24 – 27 V DC
- 4) 48 – 60 V DC
- 5) 110 – 130 V DC
- 6) 200 – 240 V DC
- 7) 24 V 50/60 Hz
- 8) 42 – 48 V 50/60 Hz
- 9) 100 – 120 V 50/60 Hz
- 10) 190 – 240 V 50/60 Hz
- 11) 380 – 440 V 50/60 Hz
- 12) 480 – 500 V 50/60 Hz
- 13) Minimum order quantity 10 units
- 14) Minimum order quantity 5 units

1.2

Contactors for capacitors, contactor

Actuating voltages

1 DILK, DILMF

AC	DILK12-11 (...)	DILK20-11 (...)	DILK25-11 (...)	DILK33-10 (...)	DILK50-10 (...)
	Article no. ¹⁾	Article no. ¹⁾	Article no. ¹⁾	Article no. ¹⁾	Article no. ¹⁾
Standard voltages	See price list	See price list	See price list	See price list	See price list
110V 50Hz, 120V 60Hz	293985	294007	294029	294051	294073
190V 50Hz, 220V 60Hz	293986	294008	294030	294052	294074
230V 50Hz, 240V 60Hz	293988	294010	294032	294054	294076
400V 50Hz, 440V 60Hz	293990	294012	294034	294056	294078
Special voltages other than the already shown normal voltages ²⁾	See price list	See price list	See price list		
...V 50Hz (24 – 600V)³⁾	293997	294019	294041	–	–
...V 60Hz (24 – 600V)³⁾	293998	294020	294042	–	–

Notes

- ¹⁾ The article no. results from combining the part no. and the actuating voltage. Devices with dual-voltage coils must be ordered under a single article no.
- ²⁾ With non-standard voltages the required actuating voltage from the defined range (...–...V) must be stated.
- ³⁾ Minimum order quantity 10 units

DILM

Complete comfort devices

	DILM250 /22(...)	DILM300A /22(...)	DILM400 /22(...)	DILM500 /22(...)	DILM580 /22(...)	DILM650 /22(...)	DILM750 /22(...)	DILM820 /22(...)	DILM1000 /22(...)
Voltage variants	Article no. ¹⁾ See price list	Article no. ¹⁾ See price list	Article no. ¹⁾ See price list	Article no. ¹⁾ See price list	Article no. ¹⁾ See price list	Article no. ¹⁾ See price list	Article no. ¹⁾ See price list	Article no. ¹⁾ See price list	Article no. ¹⁾ See price list
RDC 48²⁾	208199	139554	208207	208211	–	–	–	–	–
RA 110³⁾	208200	139555	208208	208212	208215	208218	208221	208224	–
RA 250⁴⁾	208201	139556	208209	208213	208216	208219	208222	208225	267214
RAC 500^{5) 6)}	208202	139557	208210	208214	208217	208220	208223	208226	–

DILM

**Complete units
Standard**

	DILM250 -S/22(...)	DILM300A -S/22(...)	DILM400 -S/22(...)	DILM500 -S/22(...)
Voltage variants	Article no. ¹⁾ See price list	Article no. ¹⁾ See price list	Article no. ¹⁾ See price list	Article no. ¹⁾ See price list
110-120V 50/60Hz	274189	139558	274195	274198
220-240V 50/60Hz	274190	139559	274196	274199

DILM

**Electronic module, incl. coil, for
comfort model**

	DILM250-XSP/E(...)	DILM500-XSP/E(...)	DILM1000-XSP/E(...)
Voltage variants	Article no. ¹⁾ See price list	Article no. ¹⁾ See price list	Article no. ¹⁾ See price list
RDC 48²⁾	208250	208254	–
RA 110³⁾	208251	208255	289146
RA 250⁴⁾	208252	208256	289145
RAC 500^{5) 6)}	208253	208257	289147

DILM

**Electronic module, incl. coil, for
standard model**

	DILM250-S-XSP/E(...)	DILM500-S-XSP/E(...)
Voltage variants	Article no. ¹⁾ See price list	Article no. ¹⁾ See price list
110-120V 50/60Hz	274201	274204
220-240V 50/60Hz	274202	274205

Notes

- ¹⁾ The article no. results from combining the part no. and the voltage variant.
- ²⁾ 24 – 48 V DC
- ³⁾ 48 – 110 V 40 – 60 Hz/48 – 110 V DC
- ⁴⁾ 110 – 250 V 40 – 60 Hz/110 – 250 V DC
- ⁵⁾ 250 – 500 V 40 – 60 Hz
- ⁶⁾ DC on request

1 Engineering

DILM, DILA, DILE, DILH

The diagrams show the closing and opening travel of the contacts at no load.

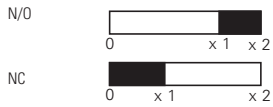

		x1	x2
DILE AC	N/O	1.9	2.8
	NC	0.95	2.8
...DILE	N/O	1.9	2.8
	NC	0.9	2.8
...DDILE	NO early-make	1.06	2.9
	Late-break N/C contact	1.86	2.9
	N/O	1.9	2.8
	NC	0.9	2.8
DILE DC	N/O	1.9	2.85
	NC	0.95	2.85
DILE...	N/O	1.9	2.8
	NC	0.9	2.8
...DDILE	NO early-make	1.06	2.9
	Late-break N/C contact	1.86	2.9
	N/O	1.9	2.8
	NC	0.9	2.8
DILA AC	N/O	3.3	4.5
	NC	1.0	4.5
DILA-XHI	N/O	3.2	4.5
	NC	1.6	4.5
DILA-XHIV	NO early-make	2.0	4.5
	Late-break N/C contact	2.8	4.5
	N/O	3.2	4.5
	NC	1.6	4.5
DILA DC	N/O	2.1	2.9
	NC	0.7	2.9
DILA-XHI	N/O	2.3	2.9
	NC	0.7	2.9
DILA-XHIV	NO early-make	1.1	2.9
	Late-break N/C contact	1.9	2.9
	N/O	2.3	2.9
	NC	0.7	2.9
DILM7/9 AC	N/O	3.3	4.5
	NC	1.0	4.5
DILM32-XHI, DILA-XHI	N/O	3.2	4.5
	NC	1.6	4.5
DILA-XHIV	NO early-make	2.0	4.5
	Late-break N/C contact	2.8	4.5
	N/O	3.2	4.5
	NC	1.6	4.5
DILM7/9 DC	N/O	2.1	2.9
	NC	0.7	2.9
DILM32-XHI, DILA-XHI	N/O	2.3	2.9
	NC	0.7	2.9
DILA-XHIV	NO early-make	1.1	2.9
	Late-break N/C contact	1.9	2.9
	N/O	2.3	2.9
	NC	0.7	2.9
DILM12/15/P20 AC	N/O	3.3	4.5
	NC	1.0	4.5
DILM32-XHI, DILA-XHI	N/O	3.2	4.5
	NC	1.6	4.5
DILA-XHIV	NO early-make	2.0	4.5
	Late-break N/C contact	2.8	4.5
	N/O	3.2	4.5
	NC	1.6	4.5
DILM12/15/P20 DC	N/O	3.3	4.4
	NC	1.0	4.4
DILM32-XHI, DILA-XHI	N/O	3.2	4.4
	NC	1.6	4.4

DILM, DILA, DILE, DILH

The diagrams show the closing and opening travel of the contacts at no load.

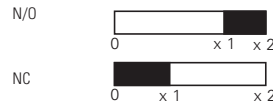

		x1	x2
DILA-XHIV	NO early-make	2.0	4.4
	Late-break N/C contact	2.8	4.4
	N/O	3.2	4.4
	NC	1.6	4.4
DILM17/25/32/P32/P45	N/O	4.0	6.0
	Auxiliary N/C	1.8	6.0
	Auxiliary N/O	3.2	6.0
DILM32-XHI, DILA-XHI	N/O	3.2	6.0
	NC	1.6	6.0
DILA-XHIV	NO early-make	2.0	6.0
	Late-break N/C contact	2.8	6.0
	N/O	3.2	6.0
	NC	1.6	6.0
DILM40/50/65/P63/P80	N/O	5.1	7.5
DILM150-XHI	N/O	5.7	7.5
	NC	3.9	7.5
DILM150-XHIV	NO early-make	3.8	7.5
	Late-break N/C contact	5.4	7.5
	N/O	5.7	7.5
	NC	3.9	7.5
DILM1000-XHI	N/O	5.5	7.5
	NC	3.6	7.5
DILM1000-XHIV	NO early-make	4.1	7.5
	Late-break N/C contact	5.0	7.5
DILM80/95/115/150/170/P125/P160/P200	N/O	8.0	11
DILM150-XHI	N/O	9.2	11
	NC	7.4	11
DILM150-XHIV	NO early-make	7.3	11
	Late-break N/C contact	8.9	11
	N/O	9.2	11
	NC	7.4	11
DILM1000-XHI	N/O	9.0	11
	NC	7.1	11
DILM1000-XHIV	NO early-make	7.6	11
	Late-break N/C contact	8.5	11
DILM185A/225A	N/O	10.0	13.0
DILM1000-XHI	N/O	10.0	13.0
	NC	8.1	13.0
DILM1000-XHIV	NO early-make	8.4	13.0
	Late-break N/C contact	9.5	13.0
DILM250/300A	N/O	10.1	13.1
DILM820-XHI	N/O	10.3	13.1
	NC	8.4	13.1
DILM820-XHIV	NO early-make	8.7	13.1
	Late-break N/C contact	9.8	13.1
DILM400/500/570	N/O	8.9	13.1
DILM820-XHI	N/O	10.3	13.1
	NC	8.4	13.1
DILM820-XHIV	NO early-make	8.7	13.1
	Late-break N/C contact	9.8	13.1
DILM580/650/750/820	N/O	2.0	4.1
DILM820-XHI	N/O	7.4	10.5
	NC	5.5	10.5
DILM820-XHIV	NO early-make	6.0	10.5
	Late-break N/C contact	6.8	10.5
DILM1000/1600, DILH1400/2000/2200/2600	N/O	2.0	4.1
DILM820-XHI	N/O	7.4	10.5
	NC	5.5	10.5
DILM820-XHIV	NO early-make	6.0	10.5
	Late-break N/C contact	6.8	10.5

DILE, DILM, SDAINL, DIUL

Components

Contactor selection

Part no.	With top mounting auxiliary contacts	With side mounting auxiliary contacts	With overload relay	With parallel connector	Insulated enclosures
DILE...(-G)(-C)	–	–	–	–	CI-K1-95-TS
DILE...(-G)(-C)	●	–	–	–	CI-K2-145-TS
DILE...(-G)	●	–	●	–	CI-K2-145-AD
DILE...(-G)	–	–	–	●	CI-K2-100-TS
DILE...(-G)	●	–	–	●	CI-K2-145-TS
DILM7 to DILM15	●	–	–	–	CI-K2-145-TS
DILM7 to DILM15	●	–	●	–	CI-K3-160-TS
DILM17 to DILM32	–	–	–	–	CI-K2-145-TS
DILM17 to DILM32	●	–	●	–	CI23E-150
DILM40 to DILM65	–	●	–	–	CI-K3-160-TS
DILM40 to DILM65	●	●	●	–	CI43E-150
DILM80 to DILM170	●	●	–	–	CI43E-200
DILM80 to DILM170	●	●	●	–	CI44E-200
DILM185A	–	●	–	–	CI48-250
DILM225A	–	●	–	–	CI48-250
DILM250	–	●	–	–	CI48-250
DILM300A	–	●	–	–	CI48-250
DILM400	–	●	–	–	CI48-250
DILM500	–	●	–	–	CI48-250
DILM580	–	●	–	–	CI48-250
DILM650	–	●	–	–	CI48-250
DILM750	–	●	–	–	CI48-250
DILM820	–	●	–	–	CI48-250
DIULE...	●	–	–	–	CI-K3-125-TS
DIULE...	●	–	●	–	CI-K3-125-TS
DIULM7 to DIULM12	●	–	–	–	CI-K4-160-TS
DIULM17 to DIULM32	●	–	–	–	CI23E-150
DIULM40 to DIULM65	●	–	–	–	CI43E-200
SDAINLEM...	●	–	–	–	CI-K5-125-TS CI-K5-125-M
SDAINLM12 to SDAINLM22	●	–	–	–	CI-K5-160-TS
SDAINLM30 to SDAINLM65	●	–	–	–	CI23E-150
SDAINLM70 to SDAINLM115	●	–	–	–	CI43E-200
Notes	CI-K small enclosure	→ See catalog	Insulated PE, N or PEN terminal for enclosure CI-K	→ See catalog	
	Terminal for CI-K enclosure	→ See catalog			
	CI enclosure	→ See catalog			

1.2

Contactors

UL/CSA-approved rating data

1 for North America

DILE, DILA, DILM

Rating data for approved types



Maximum alternating current-motor rating

Single-phase

3-phase

115 V 120 V HP	230 V 240 V HP	200 V 208 V HP	230 V 240 V HP	460 V 480 V HP	575 V 600 V HP
----------------------	----------------------	----------------------	----------------------	----------------------	----------------------

GENERAL USE

Maximum motor-rated current
 I_{th}
Open/enclosed

NEMA size

Contactors

Part no.

						A		
1/2	1 1/2	2	3	5	5	15/13.5	DILEM(4)	00
1/4	1	1 1/2	2	3	5	20	DILM7-...(...)	00
1/2	1 1/2	3	3	5	7 1/2	20	DILM9-...(...)	00
1	2	3	3	10	10	20	DILM12-...(...)	0
1	3		5	10	10	20	DILM15-...(...)	0
2	3	5	7 1/2	10	15	35	DILM17-...(...)	0
2	5	7 1/2	7 1/2	15	20	35	DILM25-...(...)	1
3	5	10	10	20	25	40	DILM32-...(...), DILM38-...(...)	1
3	7 1/2	10	15	30	40	55	DILM40(...)	2
3	10	15	20	40	50	65	DILM50(...)	2
5	15	20	25	40	60	80	DILM65(...), DILM70(...)	2
7 1/2	15	25	30	60	75	125	DILM80(...)	3
7 1/2	15	25	40	75	100	125	DILM95(...)	3
10	25	40	50	100	125	160	DILM115(...)	4
15	30	40	60	125	125	160	DILM150(...), DILM170(...)	4
–	–	50	60	125	150	225	DILM185(...)	4
–	–	60	75	150	200	250	DILM225(...)	4
–	–	75	100	200	250	350	DILM250(...)	5
–	–	100	125	250	300	350	DILM300(...)	5
–	–	125	150	300	400	450	DILM400(...)	5
–	–	150	200	400	500	550	DILM500(...)	6
–	–	200	200	400	600	630	DILM580(...)	6
–	–	200	250	500	600	700	DILM650(...)	6
–	–	250	300	600	700	800	DILM750(...)	6
–	–	290	350	700	860	850	DILM820(...)	6
–	–	350	400	800	1000	1000	DILM1000(...)	7
–	–	560	640	1200	1300	1600	DILM1600(...)	8

DILE, DILA, DILM

Approved rating data UL - File No. E29184 for auxiliary contacts



Pilot Duty

General Use

Part no.	Pilot Duty		General Use			
	AC	DC	AC V	A	DC V	A
DIL(E)EM-10(-01) DILER-40(31)(22) ...(D)DILE	A600	P300	600	10	250	0.5
DILM7-10(-01) To DILM32-10(-01) DILA...	A600	P300	600	15	250	1
DILA-XHI... DILM32-XHI...	A600	P300	600	15	250	1
DILM...-XHI11-SI DILM...-XHI11-SA DILM...-XHI11V-SI	A600	P600	600	10	–	–

Further approvals → 81

- Elevator control
- Refrigeration control
- Resistance air heating
- Incandescent lamps
- Electrical discharge lamps
- Capacitive switching

for North America

DILM, DILMP, DILK

Special purpose rating



	DIL	M7	M9	M12	M15	M17	M25 MP32 MP45	M32	M40 MP63	M50 MP80	M65 M72	M80 MP125	M95 MP160	M115	M150 M170 MP200
Electrical discharge lamps (ballast)															
480V 60Hz 3phase, 277V 60Hz 1phase	A	12	18	20	20	27	35	40	63	79	88	85	100	136	160
600V 60Hz 3phase, 347V 60Hz 1phase	A	12	18	20	20	27	35	40	63	79	88	85	100	136	160
Incandescent lamps (Tungsten)															
480V 60Hz 3phase, 277V 60Hz 1phase	A	8	11	14	14	23	32	40	55	74	88	85	100	136	160
600V 60Hz 3phase, 347V 60Hz 1phase	A	8	11	14	14	23	32	40	55	74	88	85	100	136	160
Resistance air heating															
480V60Hz 3phase, 277V60Hz 1phase	A	12	18	20	20	27	35	40	63	79	88	94	110	136	160
600V60Hz 3phase, 347V60Hz 1phase	A	12	18	20	20	27	35	40	63	79	88	94	110	136	160
Refrigeration control (CSA only)															
LRA 480V 60Hz 3phase	A	60	60	60	60	240	240	240	270	270	270	540	540	540	540
LRA 600V 60Hz 3phase	A	60	60	60	60	180	180	180	270	270	270	420	420	540	540
480V 60Hz 3phase	A	6	7.5	10	10	23	32	40	26	36	45	63	70	84	90
600V 60Hz 3phase	A	6	7.5	10	10	17	24	30	26	36	45	63	70	84	90
Elevator control															
200V 60Hz 3phase	HP (A)	¾ (3.7)	2 (7.8)	2 (7.8)	2 (7.8)	3 (11)	3 (11)	7½ (25.3)	7½ (25.3)	10 (32.2)	10 (32.2)	20 (62.1)	20 (62.1)	30 (92)	30 (92)
240V 60Hz 3phase	HP (A)	1½ (6.0)	2 (6.8)	2 (6.8)	3 (9.6)	3 (9.6)	5 (15.2)	7½ (22)	10 (28)	15 (42)	15 (42)	25 (68)	30 (80)	40 (104)	40 (104)
480V 60Hz 3phase	HP (A)	2 (3.4)	3 (4.8)	7½ (11)	7½ (11)	7½ (11)	10 (14)	20 (27)	25 (34)	30 (40)	30 (40)	50 (65)	60 (77)	75 (96)	75 (96)
600V 60Hz 3phase	HP (A)	3 (3.9)	5 (6.1)	7½ (9.6)	7½ (9.6)	10 (11)	15 (17)	20 (22)	30 (32)	40 (41)	40 (41)	60 (62)	75 (77)	100 (99)	100 (99)

DILM, DILMP, DILK

Special purpose rating



	DIL	K12	K20	K25	K33	K50
Capacitor Switching						
240V 60Hz 3phase	A	18	28	36	48	72
480V 60Hz 3phase	A	18	28	36	48	72
600V 60Hz 3phase	A	14.4	28	38.4	48	72
240V 60Hz 3phase	kvar	7.5	12	15	20	30
480V 60Hz 3phase	kvar	15	20	30	40	60
600V 60Hz 3phase	kvar	15	30	40	50	75

1.2

Contactors

UL/CSA short circuit current rating

1 for North America

DILM

Short circuit current rating (SCCR)



Contactor	Basic Rating			480 V High Fault			600 V High Fault				
	kA	Max. fuse A	Max. CB A	kA	Max. fuse A	kA	Max. CB A	kA	Max. fuse A	kA	Max. CB A
DILM7-...(…)	5	45	60	100	20 Class J	-	Fuse only	30	25	-	Fuse only
DILM9-...(…)	5	45	60	100	20 Class J	-	Fuse only	30	25	-	Fuse only
DILM12-...(…)	5	45	60	100	20 Class J	-	Fuse only	30	25	-	Fuse only
DILM15-...(…)	5	45	60		20 Class J	-	Fuse only	30	25	-	Fuse only
DILM17-...(…)	5	125	125	100	70 Class J	10	50	10	125	10	50
DILM25-...(…)	5	125	125	100	100 Class J	10	50	10	125	10	50
DILM32-...(…)	5	125	125	100	125 Class J	10	50	10	125	10	50
DILM38-...(…)	5	125	125	100	125 Class J	10	50	10	125	10	50
DILM40(…)	10	250	250	100	150 Class J	65	100	30	250	30	250
DILM50(…)	10	250	250	100	150 Class J	65	100	30	250	30	250
DILM65(…)	10	250	250	100	150 Class J	65	100	30	250	30	250
DILM72(…)	10	250	250	100	150 Class J	65	100	30	250	30	250
DILM80(…)	10	600	600	100	300 Class J	65	250	30	300	30	350
DILM95(…)	10	600	600	100	300 Class J	65	250	30	300	30	350
DILM115(…)	10	600	600	100	300 Class J	65	250	30	300	30	350
DILM150(…)	10	600	600	100	300 Class J	65	250	30	300	30	350
DILM170(…)	10	600	600	100	300 Class J	65	250	30	300	30	350
DILM185(…)	18	700	600	-	CB only	65	250	-	-	-	-
DILM225(…)	18	700	600	-	CB only	65	250	-	-	-	-
DILM250(…)	18	700	600	-	CB only	65	250	-	-	-	-
DILM300(…)	30	800	600	-	CB only	42	600	30	800	30	600
DILM400(…)	30	800	600	-	CB only	42	600	30	800	30	600
DILM500(…)	30	800	600	-	CB only	42	600	30	800	30	600
DILM570(…)	30	800	600	-	CB only	42	600	30	800	30	600
DILM580(…)	30	2000	1200	85	2000	85	1200	85	2000	85	1200
DILM650(…)	30	2000	1200	85	2000	85	1200	85	2000	85	1200
DILM750(…)	42	2000	1200	85	2000	85	1200	85	2000	85	1200
DILM820(…)	42	2000	1200	85	2000	85	1200	85	2000	85	1200
DILM1000(…)	85	2000	1200	85	2000	85	1200	85	2000	85	1200
DILM1600(…)	85	2000	-	85	2000	-	-	85	2000	85	-

1.2

Contactors

Contactors for resistive load

1 DILM, DILEM

Rating data

Single-phase rating AC-1

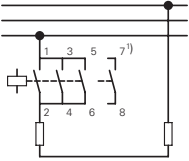

Three-phase rating AC-1

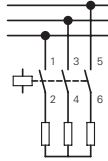

Three-phase rating AC-1

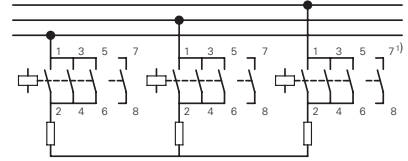

Single-phase rating AC-1					Three-phase rating AC-1					Three-phase rating AC-1				
Voltage in V			Max. upstream fuse gG/gL	Rated operational current $I_e = I_{th}$ or I_{the}	Voltage in V			Max. upstream fuse gG/gL	Rated operational current $I_e = I_{th}$ or I_{the}	Voltage in V			Max. upstream fuse gG/gL	Rated operational current $I_e = I_{th}$ or I_{the}
220	380	660			220	380	660			220	380	660		
kW	kW	kW	A	A	kW	kW	kW	A	A	kW	kW	kW	A	A
230	400	690			230	400	690			230	400	690		
240	440				240	440				240	440			

Open version

10	18	31	50	50	7	13	20	20	20	18	31	54	50	50
10	18	31	50	50	7	13	20	20	20	18	31	54	50	50
12	21	37	63	60	–	–	–	–	–	21	37	65	63	60
10	18	31	–	50	7	13	22	–	20	18	31	54	–	50
13	22	38	–	60	–	–	–	–	–	22	38	65	–	60
18	32	55	–	88	13	22	38	–	35	32	55	95	–	88
21	36	63	–	100	14	25	43	–	40	36	63	109	–	100
26	45	78	–	125	18	31	54	–	50	45	78	136	–	125
34	59	102	–	163	24	41	71	–	65	59	102	176	–	163
42	72	125	–	200	29	50	87	–	80	72	125	217	–	200
47	81	141	–	225	33	56	98	–	90	81	141	244	–	225
57	99	172	–	275	40	69	119	–	110	100	172	299	–	275
68	117	204	–	325	47	81	141	–	130	118	203	353	–	325
84	144	251	–	400	58	100	174	–	160	145	250	434	–	400
101	175	317	–	460	70	120	220	–	185	175	302	549	–	460
144	248	431	800	688	100	172	299	315	275	262	453	786	–	688
165	284	494	800	788	114	197	342	315	315	300	519	900	–	788
172	297	516	1000	825	120	206	357	400	330	333	576	1000	–	875
183	316	548	1000	875	126	219	380	400	350	381	658	1143	–	1000
261	451	784	1250	1250	181	313	543	500	500	476	825	1429	–	1250
366	632	1097	–	1750	253	438	760	800	700	667	1152	2000	–	1750
418	722	1254	–	2000	290	500	869	800	800	762	1316	2286	–	2000
444	767	1332	–	2125	308	531	923	1000	850	810	1400	2429	–	2125
470	812	1411	–	2250	326	563	977	1000	900	857	1480	2572	–	2250
523	903	1568	–	2500	362	625	1086	1000	1000	953	1646	2858	–	2500
732	1264	2195	–	3500	507	875	1520	–	1400	1334	2300	4000	–	3500
1045	1805	3135	–	5000	724	1251	2172	–	2000	1905	3290	5716	–	5000
1150	1985	3449	–	5500	796	1376	2389	–	2200	2095	3619	6288	–	5500
1358	2346	4075	–	6500	941	1626	2827	–	2600	2476	4277	7430	–	6500

Notes

¹⁾ Contact 7 – 8 only with DILEM4(-G), DILMP20...

DILM, DILEM

Part no.	Ordering data	Required accessories:	Notes
		Paralleling links	

AC operated	Page	Part no.	Accessories	Page
DILEM-10(...)	→ 4	P1DILEM		
DILEM-01(...)	→ 4	P1DILEM		
DILEM4(...)	→ 4	P1DILEM		
DILM7-...(...)	→ 18	DILM12-XP1	Auxiliary contact modules	→ 6
DILMP20(...)	→ 34	DILM12-XP1	Set of paralleling links	→ 36
DILM17-...(...)	→ 18	DILM32-XP1	Enclosure	→ 53
DILM25-...(...)	→ 18	DILM32-XP1	Accessories	→ 63
DILM40(...)	→ 20	DILM65-XP1		→ 52
DILM50(...)	→ 20	DILM65-XP1		
DILM65(...)	→ 20	DILM65-XP1		
DILM80(...)	→ 20	DILM150-XP1		
DILM95(...)	→ 20	DILM150-XP1		
DILM115(...)	→ 20	DILM150-XP1		
DILM150(...)	→ 20	DILM150-XP1		
DILM170(...)	→ 20	DILM150-KP1		
DILM185A(...)	→ 30	DILM185-XP1		
DILM225A(...)	→ 30	DILM185-XP1		
DILM250(...)	→ 30	–		
DILM300A(...)	→ 30	–		
DILM400(...)	→ 30	–		
DILM500(...)	→ 30	–		
DILM580(...)	→ 30	–		
DILM650(...)	→ 30	–		
DILM750(...)	→ 30	–		
DILM820(...)	→ 30	–		
DILH1400(...)	→ 32	–		
DILH2000(...)	→ 32	–		
DILH2200(...)	→ 32	–		
DILH2600(...)	→ 32	–		

1.2 Mini contactor relays, contactor relays

Electrical lifespan

1 DILA (AC-15)

Component lifespan (operations)
 I_e = Rated operational current

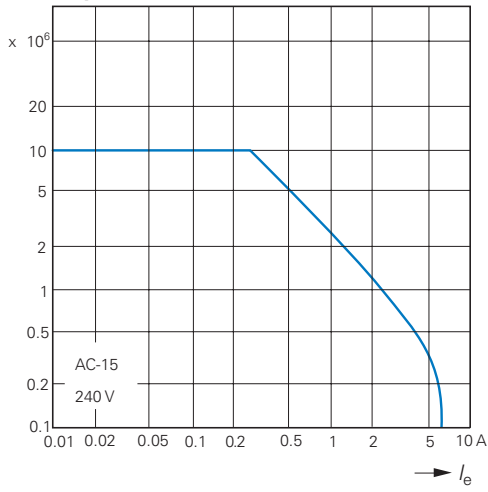

DILA DC¹⁾

Component lifespan (operations)
 I_e = Rated operational current

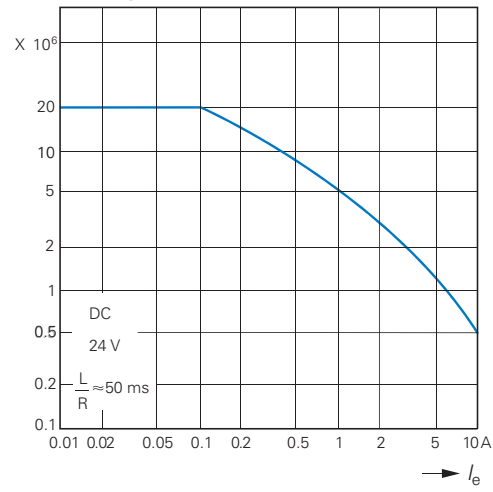

¹⁾ Three contacts in series

DILER (AC-15)

Component lifespan (operations)
 I_e = Rated operational current

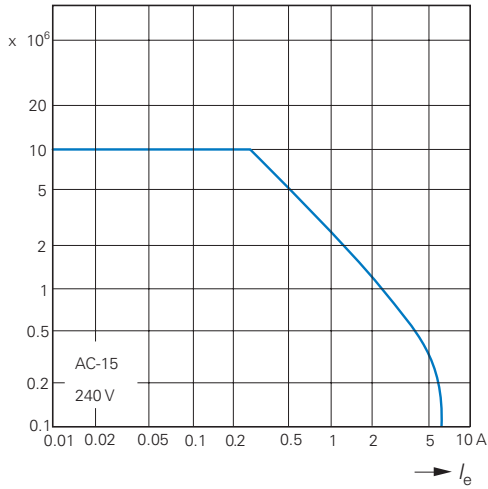

Normal switching duty

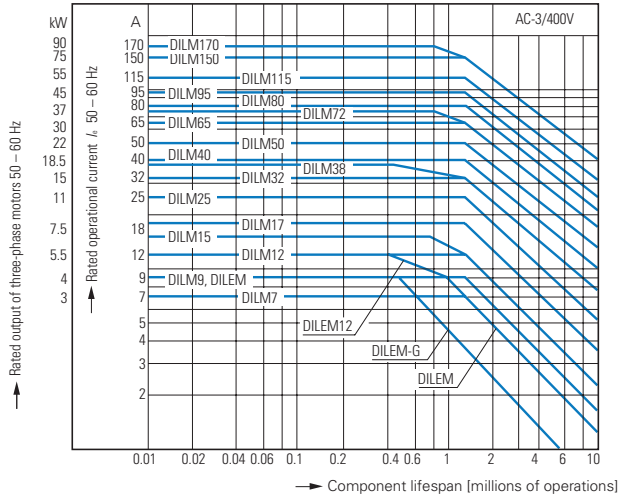

Normal AC induction motor

Operating characteristics

Make: from stop

Break: during run

Electrical characteristics:

Make: up to 6 X rated motor current

Break: 1 X rated motor current

Utilization category

100 % AC-3

Typical applications:

- | | | |
|--|-----------------|-----------------------|
| Compressors | Lifts | Mixers |
| Pumps | Escalators | Agitators |
| Fan | Conveyor belts | Centrifuges |
| Hinged flaps | Bucket-elevator | Air conditioning sys- |
| General drives for manufacturing and processing machines | | |

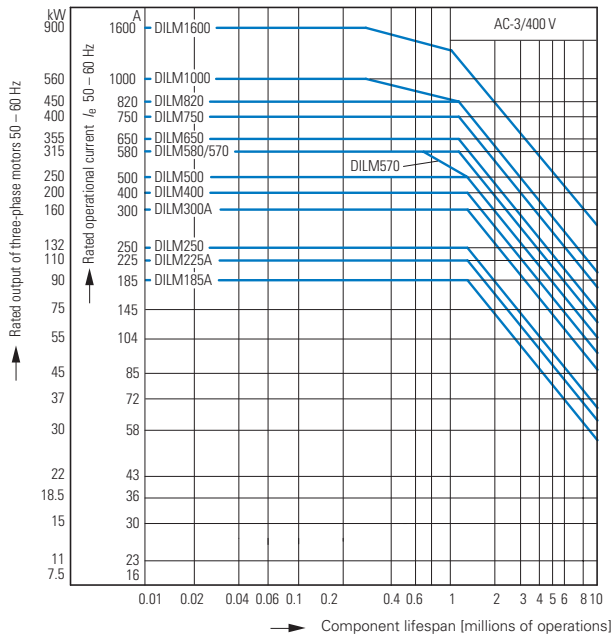

Extreme switching duty

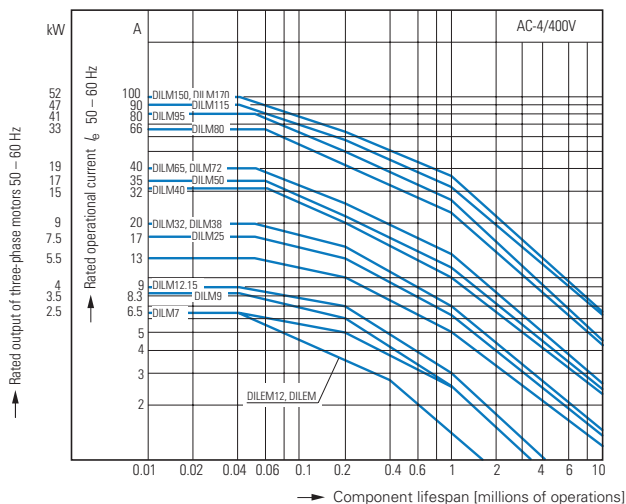

Normal AC induction motor

Operating characteristics

Inching, plugging, reversing

Electrical characteristics:

Make: up to 6 X rated motor current

Break: 6 X rated motor current

Utilization category

100 % AC-4

Typical applications:

- | | | |
|---|--------------|-------------|
| Printing machines | Wire-drawing | Centrifuges |
| Special drives on manufacturing and processing machines | | |

1.2

Contactors

Switching conditions

1 Extreme switching duty

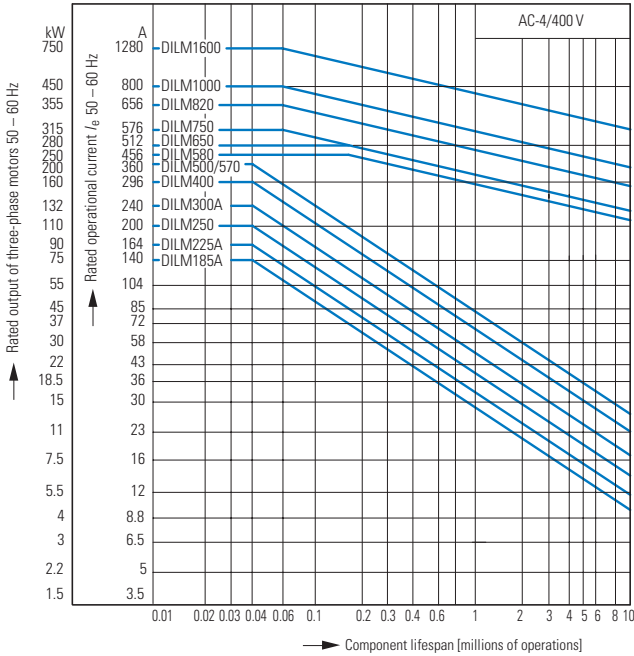

Normal AC induction motor

Operating characteristics

Inching, plugging, reversing

Electrical characteristics:

Make: up to 6 X rated motor current

Break: 6 X rated motor current

Utilization category

100% AC-4

Typical applications:

Printing machines Wire-drawing machines Centrifuges

Special drives on manufacturing and processing machines

Switching conditions for 3 pole, non-motor loads

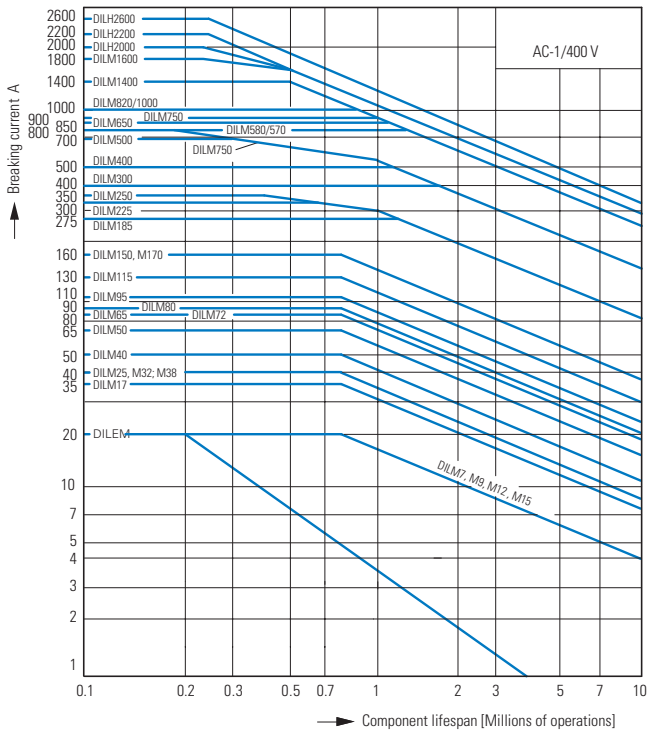

Operating characteristics

Non inductive and slightly inductive loads

Electrical characteristics:

Make: 1 X rated operational current

Break: 1 X rated operational current

Utilization category

100% AC-1

Typical applications:

Electric heat

Switching conditions for 4 pole, non-motor loads

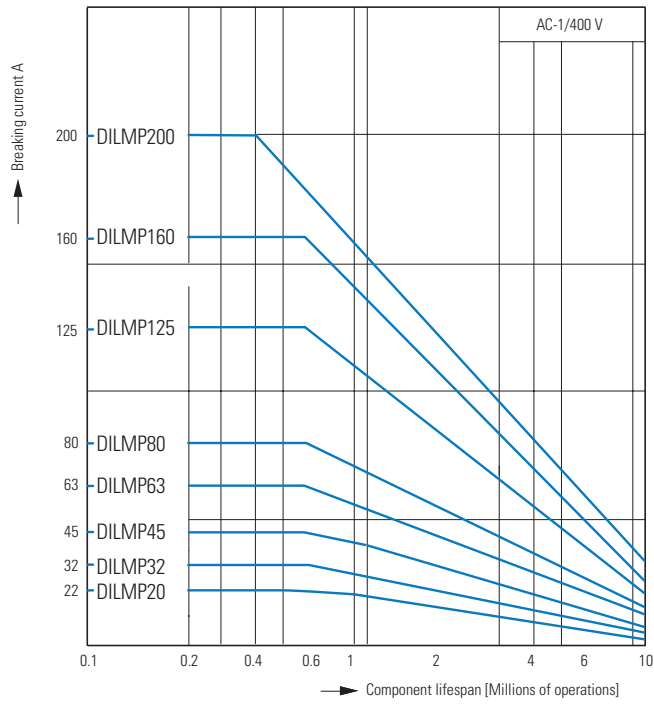

- Operating characteristics
 - Non inductive and slightly inductive loads
- Electrical characteristics:
 - Make: 1 X rated operational current
 - Break: 1 X rated operational current
- Utilization category
 - 100% AC-1
- Typical applications:
 - Electric heat

1.2

Contactors Short-time loading

1 Short-time loading 3 pole

Time interval between two loads: 15 minutes

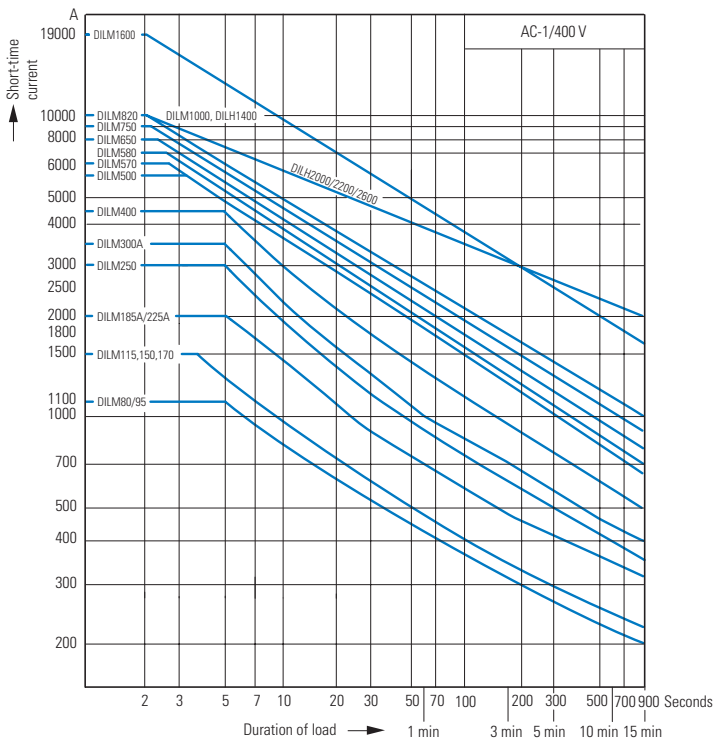
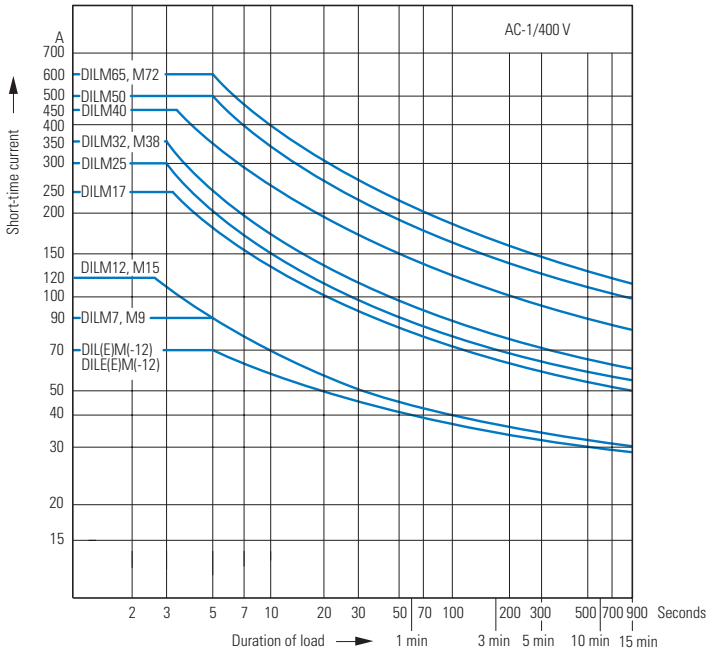

Determination of the maximum operating frequency dependent on the rating and utilization category (recommended values) for 400 V

P_N = max. rated motor output (kW) of respective contactor according to → Page 18 and → Page 4
 S/h = max. operation per hour

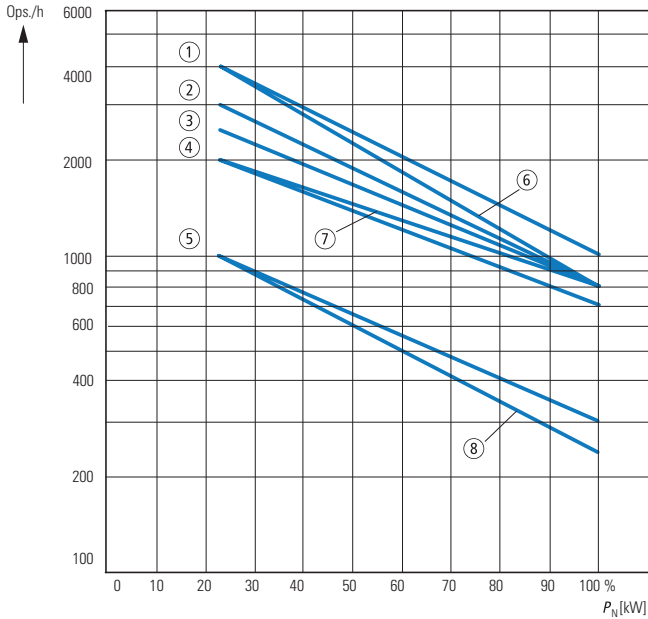

DILEM, DILM, DILH

Part no.	Characteristic		
	AC-1	AC-3	AC-2 AC-4
DILE(E)M(-12)	7	6	8
DILM7, 9, 12, 15	3	1	5
DILM17, 25, 32, 38	3	2	5
DILM40, 50, 65, 72	3	2	5
DILM80, 95, 115, 150, 170	3	4	5

Determination of the maximum operating frequency dependent on the rating and utilization category (recommended values)

P_N = max. rated motor output (kW) of respective contactor according to → Page 28 and → Page 32
 S/h = max. operation per hour

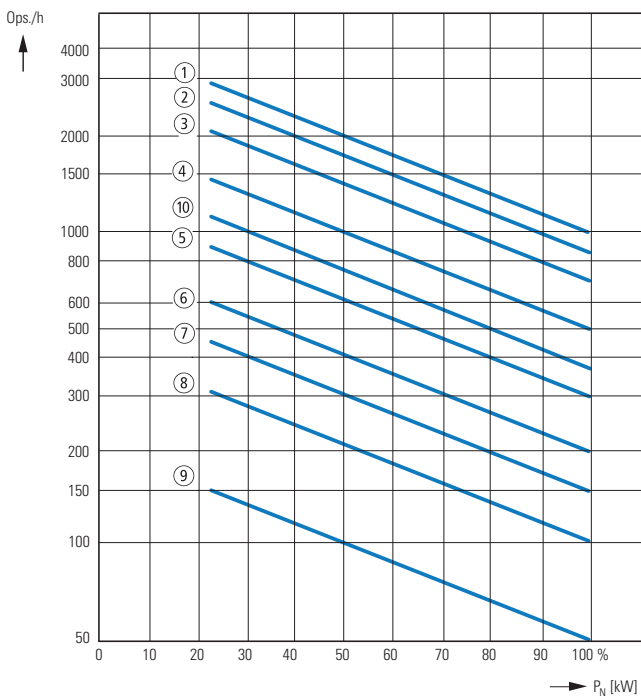

DILEM, DILM, DILH

Part no.	Characteristic		
	AC-1	AC-3	AC-4
DILM185A	2	1	8
DILM225A	2	1	8
DILM250	2	1	8
DILM300A	3	2	9
DILM400	3	2	9
DILM500	3	2	9
DILM580	3	4	7
DILM650	3	4	7
DILM750	3	4	7
DILM820	3	4	7
DILM1000	3	4	7
DILM1600	10	10	7
DILH1400	10	–	–
DILH2000	10	–	–
DILH2200	10	–	–
DILH2600	10	–	–

1.2

Contactors

Switching of DC current

1 DC current switching

----- when necessary
conductor to be
supplied by customer

DILEEM ... DILM700

1 pole

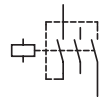

> 60 V DC

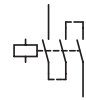

With overload relay
> 60 V DC

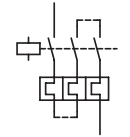

2 pole

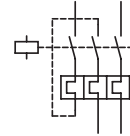
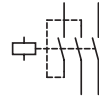

DILEM4 DILMP...

1 pole

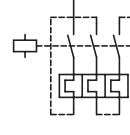
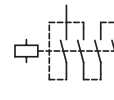

2 pole

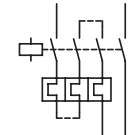

Wiring, star-delta combination with DILM32-XTEY20

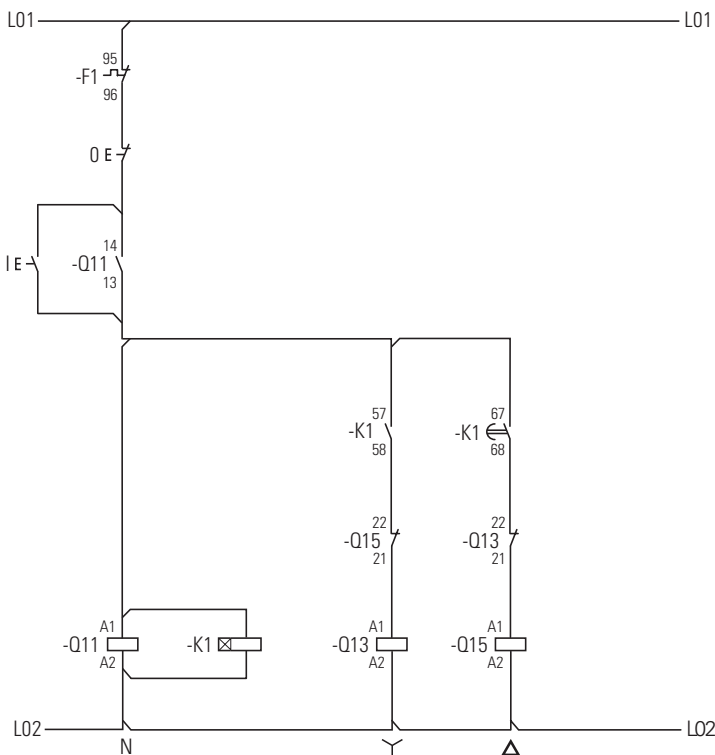

Technical data

DILER, DILA

			DILA	DILA...XHI	DILER	DILE...
General						
Standards			IEC/EN 60947, VDE 0660, UL, CSA			
Lifespan, mechanical						
AC operated	Operations	x 10 ⁶	20	10	10	10
DC operated	Operations	x 10 ⁶	20	10	20	20
Maximum operating frequency						
Maximum operating frequency	Operations/h		9000	9000	9000	9000
Climatic proofing						
			Damp heat, constant, to IEC 60068-2-78; Damp heat, cyclic, to IEC 60068-2-30			
Ambient temperature						
Open		°C	-25...60	-25...60	-25...50	-25...50
Enclosed		°C	-25...40	-25...40	-25...40	-25...40
Ambient temperature for storage		°C	-40 - 80	-40 - 80		
Mounting position						
						Any, except vertically with terminals A1/A2 below
Mechanical shock resistance (IEC/EN 60068-2-27)						
Half-sinusoidal shock 10 ms						
Basic devices with auxiliary contact module						
		g	7	7	10	10
	N/O	g	7	7	10	10
	NC	g	5	5	8	8
Protection type						
			IP20	IP20	IP20	IP20
Protection against direct contact when actuated from front (EN 50274)						
			Finger- and back-of-hand proof			
Weight						
AC operated		kg	0.23	0.05	0.17	–
DC operated		kg	0.28	0.05	0.2	–
Terminal capacity						
Screw terminals						
	Solid	mm ²	1 x (0.75 - 4) 2 x (0.75 - 2.5)	1 x (0.75 - 4) 2 x (0.75 - 2.5)	1 x (0.75 - 2.5) 2 x (0.75 - 2.5)	1 x (0.75 - 2.5) 2 x (0.75 - 2.5)
	Flexible with ferrule	mm ²	1 x (0.75 - 2.5) 2 x (0.75 - 2.5)	1 x (0.75 - 2.5) 2 x (0.75 - 2.5)	1 x (0.75 - 1.5) 2 x (0.75 - 1.5)	1 x (0.75 - 1.5) 2 x (0.75 - 1.5)
	Solid or stranded	AWG	18 - 14	18 - 14	18 - 14	18 - 14
	Terminal screw		M3.5	M3.5	M3.5	M3.5
	Pozidriv screwdriver	Size	2	2	2	2
	Flat-blade screwdriver	mm	0.8 x 5.5 1 x 6	0.8 x 5.5 1 x 6	0.8 x 5.5 1 x 6	0.8 x 5.5 1 x 6
	Max. tightening torque	Nm	1.2	1.2	1.2	1.2
Spring-loaded terminals						
	Solid	mm ²	1 x (0.75 - 2.5) 2 x (0.75 - 2.5)	1 x (0.75 - 2.5) 2 x (0.75 - 2.5)	1 x (1 - 2.5) 2 x (1 - 2.5)	1 x (1 - 2.5) 2 x (1 - 2.5)
	Flexible with ferrule	mm ²	1 x (0.75 - 1.5) 2 x (0.75 - 1.5)	1 x (0.75 - 1.5) 2 x (0.75 - 1.5)	1 x (1 - 2.5) 2 x (1 - 2.5)	1 x (1 - 2.5) 2 x (1 - 2.5)
	Flexible without ferrule DIN 46228	mm ²	1 x (0.75 - 2.5) 2 x (0.75 - 2.5)	1 x (0.75 - 1.5) 2 x (0.75 - 1.5)	–	–
	Solid or stranded	AWG	18 - 14	18 - 14	1 x (16 - 14) 2 x (16 - 14)	1 x (16 - 14) 2 x (16 - 14)
	Flat-blade screwdriver	mm	0.6 x 3.5	0.6 x 3.5	0.6 x 3.5	0.6 x 3.5

1.2 Mini contactor relays, contactor relays

1 DILER, DILA

				DILA	DILA...XHI	DILER	DILE...
Contacts							
Interlocked opposing contacts to EN 60947-4-1, Annex L, including auxiliary contact module				Yes	Yes	Yes	Yes
Rated impulse withstand voltage	U_{imp}	V AC	6000	6000	6000	6000	6000
Overvoltage category/degree of pollution				III/3	III/3	III/3	III/3
Rated insulation voltage	U_i	V AC	690	690	690	690	690
Rated operating voltage	U_e	V AC	690	500	600	600	600
Safe isolation according to EN 61140							
Between coil and auxiliary contacts				V AC	400	300	300
Between the auxiliary contacts				V AC	400	300	300
Rated operational current							
AC-15							
220/240 V	I_e	A	4	4	6	4	
380/415 V	I_e	A	4	4	3	2	
500 V	I_e	A	1.5	1.5	1.5	1.5	
DC ¹⁾							
L/R \leq 15 ms							
Contacts in series:							
1	24 V	A	10	10	2.5	2.5	
1	60 V	A	6	6	–	–	
2	60 V	A	10	10	2.5	2.5	
1	110 V	A	3	3	–	–	
3	110 V	A	6	6	1.5	1.5	
1	220 V	A	1	1	–	–	
3	220 V	A	5	5	0.5	0.5	
L/R \leq 50 ms							
Contacts in series:							
3	24 V	A	4	2.5	–	–	
3	60 V	A	4	1	–	–	
3	110 V	A	2	0.5	–	–	
3	220 V	A	1	0.25	–	–	
DC-13 (6xP)							
Contacts in series:							
3	24 V	A	2.5	2.5	–	–	
3	60 V	A	1	1	–	–	
3	110 V	A	0.5	0.5	–	–	
3	220 V	A	0.25	0.25	–	–	
Control circuit reliability (at $U_e = 24$ V DC, $U_{min} = 17$ V, $I_{min} = 5.4$ mA)				Fault probability	λ	<10 ⁻⁸ , < one failure in 100 million operations	
Conventional thermal current				I_{th}	A	16	16
Short-circuit strength without welding				Maximum overcurrent protection device			
220/240 V				PKZM0	4	–	4
380/415 V				PKZM0	4	–	4
Short-circuit protection rating maximum fuse ²⁾				500 V			
500 V				A gG/gL	10	10	6
500 V				A fast	–	–	10
Current heat loss at load of I_{th}							
AC operated				W	0.3	0.3	0.2
DC operated				W	0.3	0.3	0.3

Notes

¹⁾ Switch-on and switch-off conditions based on DC-13, time constant as specified

²⁾ See characteristic curve "Fuses" for time/current characteristics (please enquire)

DILER, DILA

1

			DILA	DILA...XHI	DILER	DILE...	
Magnet systems							
Voltage tolerance							
AC operated							
	Single-voltage coil 50 Hz and dual-voltage coil 50 Hz, 60 Hz	Pick-up	$x U_c$	0.8...1.1	–	0.8...1.1	–
	Dual-frequency coil 50/60 Hz	Pick-up	$x U_c$	0.8...1.1	–	0.85...1.1	–
DC operated ¹⁾							
	Starting voltage	Pick-up	$x U_c$	0.8...1.1	–	0.85...1.3	–
	At 24 V: without auxiliary contact module (40 °C)	Pick-up	$x U_c$	0.7 - 1.3	–	0.7 - 1.3	–
Power consumption							
	50 Hz	Pick-up	VA	24	–	25	–
	50 Hz	Sealing	VA	3.4	–	4.6	–
	50 Hz	Sealing	W	1.2	–	1.3	–
	60 Hz	Pick-up	VA	30	–	25	–
	60 Hz	Sealing	VA	4.4	–	4.6	–
	60 Hz	Sealing	W	1.4	–	1.3	–
	50/60 Hz	Pick-up	VA	27 25	–	30 29	–
	50/60 Hz	Sealing	VA	4.2 3.3	–	5.4 3.9	–
	50/60 Hz	Sealing	W	1.4 1.2	–	1.6 1.1	–
	DC operated	Pick-up = sealing	W	3	–	2.6	–
Duty factor			% DF	100	–	100	–
Changeover times at 100 % U_c (recommended values)							
	AC operated closing delay		ms	15 - 21	–	14 - 21	–
	AC operated normally open contact opening delay		ms	9 - 18	–	8 - 18	–
	AC operated with auxiliary contact module, max. closing delay		ms	–	–	45	45
	DC operated closing delay		ms	31	–	26 - 35	–
	DC operated normally open contact opening delay		ms	12	–	15 - 25	–
	DC operated with auxiliary contact module, max. closing delay		ms	–	–	70	70

Notes

¹⁾ Smoothed DC, three-phase bridge rectifier or smoothed two-phase bridge rectifier

1.2

Contactors

Amplifier modules, electronic timer module, contactor monitoring device

1 ETS-VS3, DILM, CMD

			ETS4-VS3	DILM32-XTE	CMD(24VDC) CMD(220-240VAC)
General					
Standards			IEC/EN 60947, VDE 0660, UL, CSA	DIN EN 61812, IEC/EN 60947, VDE 0660, UL, CSA	IEC/EN 60947 UL CSA
Lifespan, mechanical					
AC operated	c (contacts)	x 10 ⁶	–	3	10
DC operated	c (contacts)	x 10 ⁶	30	3	3
Maximum operating frequency					
DC operated	c (contacts)	x 10 ⁶	72000	–	9000
Climatic proofing					
			Damp heat, constant, to IEC 60068-2-78 Damp heat, cyclic, to IEC 60068-2-30		
Ambient temperature					
Storage		°C	–	-40 - 80	-40 - 80
Open		°C	-25 - 60	-25 - 60	-25 - 50
Enclosed		°C	-25 - 45	-25 - 40	–
Mounting position			Any	As required, except suspended	Any
Mechanical shock resistance (IEC/EN 60068-2-27)					
Half-sinusoidal shock 20 ms					
N/O		g	10	–	–
Half-sinusoidal shock 10 ms					
N/O		g	–	6	4
NC		g	–	6	4
Protection type					
			IP20	IP20	IP20
Protection against direct contact when actuated from front (EN 50274)					
			Finger- and back-of-hand proof		
Weight		kg	0.09	0.08	0.1
Terminal capacity					
Solid		mm ²	1 x (0.75 - 2.5) 2 x (0.75 - 2.5) ¹⁾	1 x (0.75 - 2.5) 2 x (0.75 - 1.5)	1 x (0.75...2.5) 2 x (0.75...1.5)
Flexible with ferrule		mm ²	1 x (0.75 - 2.5) 2 x (0.75 - 1.5) ¹⁾	1 x (0.75 - 1.5) 2 x (0.75 - 1.5)	1 x (0.75...1.5) 2 x (0.75...1.5)
Solid or stranded		AWG	16 - 14	18 - 14	18...14
Terminal screw					
			M3.5	M3.5	M3.5
Pozidriv screwdriver					
			Size 2	2	2
Flat-blade screwdriver					
			mm 0.8 x 5.5 1 x 6	0.8 x 5.5 1 x 6	0.8 x 5.5 1 x 6
Max. tightening torque					
			Nm 1.2	1.2	1.2

Notes

¹⁾ Use equal cross-sections only

ETS-VS3, DILM, CMD

1

			ETS4-VS3	DILM32-XTE	CMD(24VDC)	CMD(220-240VAC)
Contacts						
Rated impulse withstand voltage	U_{imp}	V AC	6000	6000	8000	4000
Overvoltage category/degree of pollution			III/2	III/3	III/3	III/3
Rated insulation voltage	U_i	V AC	440	600	100	250
Rated operating voltage	U_e	V	440 AC	400 AC	24 DC	250 AC
Rated operational current						
AC-15						
220/240 V	I_e	A	2	3	–	–
280/415 V	I_e	A	2	–	–	–
DC-13 ¹⁾						
DC-13 L/R ≤ 15 ms						
Contacts in series:						
1	24 V	A	2.6	1	–	–
1	60 V	A	1	0.2	–	–
1	110 V	A	0.6	0.2	–	–
1	220 V	A	0.2	0.1	–	–
DC-13 L/R ≤ 50 ms						
Contacts in series:						
1	24 V	A	2	1	–	–
1	60 V	A	0.6	0.2	–	–
1	110 V	A	0.08	0.2	–	–
1	220 V	A	0.08	0.1	–	–
DC-13 L/R ≤ 300 ms						
Contacts in series:						
1	24 V	A	0.6	1	–	–
1	60 V	A	0.2	0.2	–	–
1	110 V	A	0.08	0.2	–	–
1	220 V	A	0.03	0.1	–	–
Safe isolation according to EN 61140						
Between coil and auxiliary contacts		V AC	–	250	–	–
Between the auxiliary contacts		V AC	–	250	–	–
Control circuit reliability (at $U_e = 24$ V DC, $U_{min} = 17$ V, $I_{min} = 5.4$ mA)	Fault probability	λ	$<10^{-8}$, < one failure in 100 million operations	–	–	–
Conventional thermal current	I_{th}	A	6	4	–	–
Component lifespan						
AC-15						
230 V, $I_e = 0.1$ A	Switch operations	$\times 10^6$	7	–	–	–
230 V, $I_e = 1.2$ A	Switch operations	$\times 10^6$	1	–	–	–
Short-circuit rating without welding						
Short-circuit protection rating maximum fuse ²⁾						
500 V		A gG/gL	–	4	2	2
500 V		A fast	4	–	–	–

Notes

- ¹⁾ Switch-on and switch-off conditions based on DC-13, time constant as specified
- ²⁾ See transparent overlay "Fuses" for time/current characteristics (please enquire)

1.2

Contactors

Amplifier modules, electronic timer module, contactor monitoring device

1 ETS-VS3, DILM, CMD

			ETS4-VS3	DILM32-XTE	CMD(24VDC) CMD(220-240VAC)
Magnet systems					
Voltage tolerance					
Starting voltage					
AC operated					
	Pick-up	x U _c	–	0.85 - 1.1	0.85 - 1.1
DC operated ¹⁾					
	Pick-up	x U _c	0.85 - 1.2	0.7 - 1.2	0.85 - 1.1
Power consumption					
AC operated	Sealing	VA	–	2	4
AC operated	Sealing	W	–	1.8	4
DC operated	Pick-up = sealing	W	0.6	–	4
Duty factor		% DF	100	100	100
Changeover times at 100 % U _c (recommended values)					
DC operated closing delay		ms	7	–	–
DC operated opening delay		ms	3	–	–
Maximum operating frequency					
Max. operating frequency		Ops/h	–	3600	–
6 A/250 V		Ops/h	–	360	–
Minimum on duration					
On-delayed		ms	–	< 50	–
Off-delayed		ms	–	< 200	–
Repetition accuracy (with constant parameters)	Deviation	%	–	< 5	–
Recovery time (after 100% time delay)		ms	–	70	–
Contact changeover time					
DILM32-XTEE11/DILM32-XTED11	t ₀	ms	–	10	–
DILM32-XTEY20	t ₀	ms	–	50	–
CMD	t ₀	ms	–	–	100 ± 20%

Notes

¹⁾ Smoothed DC, three-phase bridge rectifier or smoothed two-phase bridge rectifier

DILEEM, DILEM

			DILEEM DILEM DILEM12	DILEEM-G DILEM-G DILEM12-G	DILEM4	DILEM4-G
General						
Standards			IEC/EN 60947, VDE 0660, CSA, UL			
Lifespan, mechanical; Coil 50/60 Hz	at 50 Hz		7	–	7	–
Lifespan, mechanical	c (contacts)	x 10 ⁶	10	20	20	–
Maximum operating frequency						
Mechanical		Ops/h	9000			
Electrical (Contactor without overload relay)			→ Characteristic curves Page 91			
Climatic proofing						
			Damp heat, constant, to IEC 60068-2-78 Damp heat, cyclic, to IEC 60068-2-30			
Ambient temperature						
Open		°C	-25 - 50			
Enclosed		°C	-25 - 40			
Mounting position						
			Any, except for vertically with terminals A1/A2 below			
						
Mechanical shock resistance (IEC/EN 60068-2-27)						
Half-sinusoidal shock 10 ms						
Basic device without auxiliary contact module						
	Main circuit normally open contact	g	10			
	Auxiliary contacts NC/Normally open contact	g	10/8	10/8	–	–
Basic devices with auxiliary contact module						
	Main circuit normally open contact	g	10			
	Auxiliary contacts Normally open contact/NC	g	20/20			
Protection type						
			IP20			
Protection against direct contact when actuated from front (EN 50274)						
			Finger- and back-of-hand proof			
Weight						
		kg	0.2	0.17	0.2	0.17
Terminal capacity: main and auxiliary contacts						
Solid		mm ²	1 x (0.75 - 2.5) 2 x (0.75 - 2.5)			
Flexible with ferrule		mm ²	1 x (0.75 - 1.5) 2 x (0.75 - 1.5)			
Solid or stranded		AWG	18 - 14			
Terminal screw						
			M3.5			
Pozidriv screwdriver						
		Size	2			
Flat-blade screwdriver						
		mm	0.8 x 5.5 1 x 6			
Max. tightening torque						
		Nm	1.2			
Terminal capacity springloaded terminals main and control circuits						
Solid		mm ²	1 x (1 - 2.5) 2 x (1 - 2.5)			
Flexible with ferrule		mm ²	1 x (1 - 2.5) 2 x (1 - 2.5)			
Flat-blade screwdriver						
		mm	0.6 x 3.5			

1.2 Mini contactor relays

DILEEM, DILEM

1

				DILEEM DILEEM-G	DILEM DILEM-G	DILEM4	DILEM4-G	DILEM12 DILEM12-G	
Main contacts									
Rated impulse withstand voltage	U_{imp}	V AC		6000	6000	6000	6000	6000	
Overvoltage category/pollution degree				III/3	III/3	III/3	III/3	III/3	
Rated insulation voltage	U_i	V AC		690	690	690	690	690	
Rated operating voltage	U_e	V AC		690	690	690	690	690	
Safe isolation according to EN 61140									
Between coil and contacts		V AC		300	300	300	300	300	
Between the contacts		V AC		300	300	300	300	300	
Making capacity of up to 440 V (cos ϕ as specified in IEC/EN 60947)				A	110	110	110	120	
Breaking capacity	220/230 V	A		90	90	90	90	96	
	380/400 V	A		90	90	90	90	96	
	500 V	A		64	64	64	64	72	
	660/690 V	A		42	42	42	42	42	
Devices lifespan	AC-1			→ Engineering Page 88					
	AC-3			→ Engineering Page 87					
	AC-4			→ Engineering Page 87					
Short-circuit protection rating maximum fuse									
	Type "2" coordination 500 V	gL/gG	A	10	10	10	10	20	
	Type "1" coordination 500 V	gL/gG	A	20	20	20	20	35	
AC voltage									
AC-1 operation									
Conventional thermal current 3 pole 50 - 60 Hz									
Open		at 40 °C	I_{th}	A	22	22	22	22	
		at 50 °C	I_{th}	A	20	20	20	20	
		at 55 °C	I_{th}	A	19	19	19	19	
Enclosed ¹⁾		I_{th}	A	16	16	16	16		
Conventional thermal current, 1-pole									
Open ¹⁾		I_{th}	A	50	50	60	60	50	
Enclosed ¹⁾		I_{th}	A	40	40	50	50	40	
AC-3 operation									
Rated operational current AC-3 open, 50 - 60 Hz, 3-pole1)	220/230 V	I_e	A	6.6	9	9	9	12	
	240 V	I_e	A	6.6	9	9	9	12	
	380/400 V	I_e	A	6.6	9	9	9	12	
	415 V	I_e	A	6.6	9	9	9	12	
	440 V	I_e	A	6.6	9	9	9	10.5	
	500 V	I_e	A	5	6.4	6.4	6.4	9	
Motor rating	660/690 V	I_e	A	3.5	4.8	4.8	4.8	5.2	
	220/230 V	P	kW	1.5	2.2	2.2	2.2	3.5	
	240 V	P	kW	1.8	2.5	2.5	2.5	3	
	380/400 V	P	kW	3	4	4	4	5.5	
	415 V	P	kW	3.1	4.3	4.3	4.3	5.5	
	440 V	P	kW	3.3	4.6	4.6	4.6	5.5	
AC-4 operation	500 V	P	kW	3	4	4	4	5.5	
	660/690 V	P	kW	3	4	4	4	4	
	Rated operational current AC-4 open, 50 - 60 Hz, 3-pole1)	220/230 V	I_e	A	5	6.6	6.6	6.6	6.6
		240 V	I_e	A	5	6.6	6.6	6.6	6.6
		280/400 V	I_e	A	5	6.6	6.6	6.6	6.6
		415 V	I_e	A	5	6.6	6.6	6.6	6.6
440 V		I_e	A	5	6.6	6.6	6.6	6.6	
500 V		I_e	A	3.7	5	5	5	5	
Rated operational power	660/690 V	I_e	A	2.9	3.4	3.4	3.4	3.4	
	220/230 V	P	kW	1.1	1.5	1.5	1.5	1.5	
	240 V	P	kW	1.3	1.8	1.8	1.8	1.8	
	380/400 V	P	kW	2.2	3	3	3	3	
	415 V	P	kW	2.3	3.1	3.1	3.1	3.1	
	440 V	P	kW	2.4	3.3	3.3	3.3	3.3	
500 V	P	kW	2.2	3	3	3	2.2		
660/690 V	P	kW	2.2	3	3	3	2.2		

Notes

¹⁾ At maximum permissible ambient air temperature

DILEEM, DILEM

				DILEEM	DILEEM-G	DILEM	DILEM-G	DILEM4	DILEM4-G	DILEM12	DILEM12-G	
DC voltage												
Operations				→ Engineering Page 92								
Rated operational current open												
DC-1	12 V	I_e	A	20	20	20	20	20	20	20	20	
	24 V	I_e	A	20	20	20	20	20	20	20	20	
	60 V	I_e	A	20	20	20	20	20	20	20	20	
	110 V	I_e	A	20	20	20	20	20	20	20	20	
	220 V	I_e	A	20	20	20	20	20	20	20	20	
DC-3	12 V	I_e	A	6	6	8	8	8	8	8	8	
	24 V	I_e	A	6	6	8	8	8	8	6	8	
	60 V	I_e	A	3	3	4	4	4	4	4	4	
	110 V	I_e	A	2	2	3	3	3	3	3	3	
	220 V	I_e	A	–	–	–	–	1	1	–	–	
DC-5	12 V	I_e	A	1.8	1.8	2.5	2.5	2.5	2.5	2.5	2.5	
	24 V	I_e	A	1.8	1.8	2.5	2.5	2.5	2.5	2.5	2.5	
	60 V	I_e	A	1.8	1.8	2.5	2.5	2.5	2.5	2.5	2.5	
	110 V	I_e	A	1.8	1.8	1.5	1.5	2.5	2.5	1.5	1.5	
	220 V	I_e	A	0.2	0.2	0.3	0.3	1	1	0.3	0.3	
Current heat loss (3-pole or 4-pole)												
At I_{th}				W	2	3.5	2	3.5	2.7	4.7	2	3.5
At I_e to AC-3/400 V				W	0.5	0.7	0.5	0.7	–	–	0.5	0.7
Magnet systems												
Voltage tolerance												
Single-voltage coil 50 Hz and dual-voltage coil 50 Hz, 60 Hz		Pick-up	$x U_c$	0.8 - 1.1	–	0.8 - 1.1	–	0.8 - 1.1	–	0.8 - 1.1	–	
Dual-frequency coil 50/60 Hz		Pick-up	$x U_c$	0.8 - 1.1	–	0.85 - 1.1	–	0.85 - 1.1	–	0.8 - 1.1	–	
DC operated		Pick-up	$x U_c$	–	0.8 - 1.1	–	0.8 - 1.1	–	0.85 - 1.1	–	0.8 - 1.1	
Power consumption												
AC operation	Single-voltage coil, 50 Hz, and dual-voltage coil, 50 Hz, 60 Hz	Pick-up	VA	25	–	25	–	25	–	25	–	
		Pick-up	W	22	–	22	–	22	–	22	–	
		Sealing	VA	4.6	–	4.6	–	4.6	–	4.6	–	
		Sealing	W	1.3	–	1.3	–	1.3	–	1.3	–	
	Dual-frequency coil 50/60 Hz at 50 Hz	Pick-up	VA	30	–	30	–	30	–	30	–	
		Pick-up	W	26	–	26	–	26	–	26	–	
		Sealing	VA	5.4	–	5.4	–	5.4	–	5.4	–	
		Sealing	W	1.6	–	1.6	–	1.6	–	1.6	–	
		Dual-frequency coil 50/60 Hz at 60 Hz	Pick-up	VA	29	–	29	–	29	–	29	–
			Pick-up	W	24	–	24	–	24	–	24	–
	Sealing		VA	3.9	–	3.9	–	3.9	–	3.9	–	
	Sealing		W	1.1	–	1.1	–	1.1	–	1.1	–	
	Single-voltage coil, 50 Hz, and dual-voltage coil, 50 Hz, 60 Hz	Pick-up	VA	25	–	25	–	25	–	25	–	
		Dual-frequency coil 50/60 Hz at 50 Hz	Pick-up	VA	30	–	30	–	30	–	30	–
Pick-up			VA	29	–	29	–	29	–	29	–	
DC operation ¹⁾		Power consumption pick-up = sealing		VA/W	–	2.6	–	2.6	–	2.6	–	2.6
Duty fac tor				% DF	100	100	100	100	100	100	100	
Switching times at 100 % U_c												
N/O	Closing delay min.	ms		14	26	14	26	14	26	14	26	
	Closing delay max.	ms		21	35	21	35	21	35	21	35	
	Opening delay min.	ms		8	15	8	15	8	15	8	15	
	Opening delay max.	ms		18	25	18	25	18	25	18	25	
	Closing delay with top mounting auxiliary contact	ms		Max. 45	Max. 70	Max. 45	Max. 70	Max. 45	Max. 70	Max. 45	Max. 70	
Reversing con-	Changeover time at 110 % U_c factors											
		Changeover time min.	ms	16	40	16	40	16	40	16	40	
		Changeover time maX.	ms	21	50	21	50	21	50	21	50	
		Arcing time at 690 V AC	ms	Max. 12	Max. 12	Max. 12	Max. 12	Max. 12	Max. 12	Max. 12	Max. 12	
Coil	Lifespan, mechanical; Coil 50/60 Hz	c(contacts)	$x 10^6$	7	–	7	–	7	–	7	–	

Notes

¹⁾ Smoothed DC or three-phase bridge rectifier

1.2 Mini contactor relays

DILEEM, DILEM

1

		DILE(E)M(-12)...		...DILEM
Auxiliary contact				
Interlocked opposing contacts to EN 60947-5-1 Annex L, including auxiliary contact module		Yes		Yes
Rated impulse withstand voltage	U_{imp}	V AC	6000	6000
Overvoltage category/pollution degree		III/3		III/3
Rated insulation voltage	U_i	V AC	690	690
Rated operating voltage	U_e	V AC	600	600
Safe isolation according to EN 61140				
Between coil and auxiliary contacts		V AC	300	300
Between the auxiliary contacts		V AC	300	300
Rated operational current				
AC-15				
	220/240 V	I_e	A	6
	380/415 V	I_e	A	3
	500 V	I_e	A	1.5
DC				
	L/R \leq 15 ms			
Contacts in series:				
	1	24 V	A	2.5
	2	60 V	A	2.5
	3	100 V	A	1.5
	3	220 V	A	0.5
Conventional thermal current		I_{th}	A	10
Control circuit reliability (at $U_e = 24$ V DC, $U_{min} = 17$ V, $I_{min} = 5.4$ mA)		Fault probability	λ	$<10^{-8}$, < one failure in 100 million operations
Component lifespan at $U_e = 240$ V				
AC-15		c (contacts)	$\times 10^6$	0.2
DC ¹⁾				
	L/R = 50 ms: 2 contacts in series at $I_e = 0.5$ A	c (contacts)	$\times 10^6$	0.15
Short-circuit rating without welding				
Maximum overcurrent protective device		PKZM0-4		PKZM0-4
Short-circuit protection rating maximum fuse				
	500 V	A gG/gL	6	6
	500 V	A fast	10	10
Current heat loss at load of I_{th}				
Per contact		W	0.2	0.2

Notes ¹⁾ Switch-on and switch-off conditions based on DC-13, time constant as specified

1.2

Contactors

Basic devices up to 170 A

DILM7 ... DILM170

1

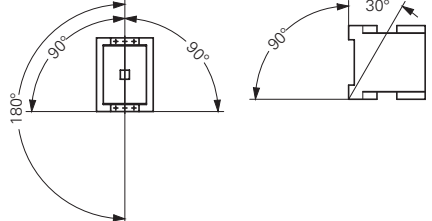
			DILM7	DILM9	DILM12	DILM15	DILM17	DILM25
General								
Standards			IEC/EN 60947, VDE 0660, UL, CSA					
Lifespan, mechanical								
AC operated	c (contacts)	x 10 ⁶	10	10	10	10	10	10
DC operated	c (contacts)	x 10 ⁶	10	10	10	10	10	10
Operating frequency, mechanical								
Mechanical, AC operated	Operations/h		9000	9000	9000	5000	5000	5000
DC operated	Operations/h		9000	9000	9000	5000	5000	5000
Maximum operating frequency								
Electrical (Contactor without overload relay)			→ Characteristic curves Page 74					
Climatic proofing			Damp heat, constant, to IEC 60068-2-78 Damp heat, cyclic, to IEC 60068-2-30					
Ambient temperature								
Open	°C		-25...60	-25...60	-25...60	-25...60	-25...60	-25...60
Enclosed	°C		-25...40	-25...40	-25...40	-25...40	-25...40	-25...40
Storage	°C		-40 - 80	-40 - 80	-40 - 80	-40 - 80	-40 - 80	-40 - 80
Mounting position AC- and DC operated								
Mechanical shock resistance (IEC/EN 60068-2-27)								
Half-sinusoidal shock 10 ms								
Main contacts								
	N/O	g	10	10	10	10	10	10
Auxiliary contacts								
	N/O	g	7	7	7	7	7	7
	NC	g	5	5	5	5	5	5
Mechanical shock resistance (IEC/EN 60068-2-27) with table mounting								
Half-sinusoidal shock 10 ms								
Main contacts								
	N/O	g	5.7	5.7	5.7	5.7	6.9	6.9
Auxiliary contacts								
	N/O	g	3.4	3.4	3.4	3.4	5.3	5.3
	NC	g	3.4	3.4	3.4	3.4	3.5	3.5
Protection type			IP20 IP20 IP20 IP20 IP00 IP00					
Protection against direct contact when actuated from front (EN 50274)			Finger- and back-of-hand proof					
Weight								
AC operated	kg		0.23	0.23	0.23	0.23	0.42	0.42
DC operated	kg		0.28	0.28	0.28	0.28	0.48	0.48
Terminal type, screw connection								
Terminal capacity of main cable								
Solid	mm ²		1 x (0.75 - 4) 2 x (0.75 - 2.5)				1 x (0.75 - 16) 2 x (0.75 - 10)	
Flexible with ferrule	mm ²		1 x (0.75 - 2.5) 2 x (0.75 - 2.5) ¹⁾				1 x (0.75 - 16) 2 x (0.75 - 10)	
Stranded	mm ²		-				1 x 16 1 x 16	
Solid or stranded	AWG		18 - 10 18 - 10 18 - 10 18 - 10				18 - 6 18 - 6	
Flat conductor	mm	Number of layers x width x thickness	-				-	
Terminal capacity of control circuit cable								
Solid	mm ²		1 x (0.75 - 4) 2 x (0.75 - 2.5)				1 x (0.75 - 4) 2 x (0.75 - 4)	
Flexible with ferrule	mm ²		1 x (0.75 - 2.5) 2 x (0.75 - 2.5)				1 x (0.75 - 2.5) 2 x (0.75 - 2.5)	
Solid or stranded	AWG		18 - 10 18 - 10 18 - 10 18 - 10				18 - 14 18 - 14	

Notes

¹⁾ Also without ferrule.

DILM32	DILM38	DILM40	DILM50	DILM65	DILM72	DILM80	DILM95	DILM115	DILM150	DILM170
--------	--------	--------	--------	--------	--------	--------	--------	---------	---------	---------

IEC/EN 60947, VDE 0660, UL, CSA

10	10	10	10	10	10	10	10	10	10	10
10	10	10	10	10	10	10	10	10	10	10
5000	5000	5000	5000	5000	5000	3600	3600	3600	3600	3000
5000	5000	5000	5000	5000	5000	3600	3600	3600	3600	3000

→ Characteristic curves Page 74

Damp heat, constant, to IEC 60068-2-78

Damp heat, cyclic, to IEC 60068-2-30

-25...60	-25...60	-25...60	-25...60	-25...60	-25...60	-25...60	-25...60	-25...60	-25...60	-25...60
-25...40	-25...40	-25...40	-25...40	-25...40	-25...40	-25...40	-25...40	-25...40	-25...40	-25...40
-40 - 80	-40 - 80	-40 - 80	-40 - 80	-40 - 80	-40 - 80	-40 - 80	-40 - 80	-40 - 80	-40 - 80	-40 - 80

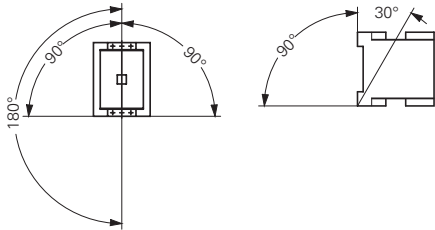

10	10	10	10	10	10	10	10	10	10	10
7	7	7	7	7	7	7	7	7	7	7
5	5	5	5	5	5	5	5	5	5	5

6.9	6.9	10	10	10	10	10	10	10	10	10
5.3	5.3	7	7	7	7	7	7	7	7	7
3.5	3.5	5	5	5	5	5	5	5	5	5
IP00	IP00	IP00	IP00	IP00	IP00	IP00	IP00	IP00	IP00	IP00

Finger- and back-of-hand proof

0.42	0.42	0.9	0.9	0.9	0.9	2	2	2	2	2
0.48	0.48	1.1	1.1	1.1	1.1	2.1	2.1	2.1	2.1	2.1

1 x (0.75 - 16)		1 x (0.75 - 16)				-	-	-	-	-
2 x (0.75 - 10)		2 x (0.75 - 16)								
1 x (0.75 - 16)		1 x (0.75 - 35)				1 x (10 - 95)				
2 x (0.75 - 10)		2 x (0.75 - 25)				2 x (10 - 70)				
1 x 16	1 x 16	1 x (16 - 50)				1 x (16 - 95)				
		2 x (16 - 35)				2 x (16 - 70)				
18 - 6	18 - 6	12 - 2	12 - 2	12 - 2	12 - 2	8...3/0	8...3/0	8...3/0	8...3/0	8...3/0
-	-	2 x (6 x 9 x 0.8)				2 x (6 x 16 x 0.8)				

1 x (0.75 - 4)
2 x (0.75 - 4)
1 x (0.75 - 2.5)
2 x (0.75 - 2.5)

18 - 14	18 - 14	18 - 14	18 - 14	18 - 14	18 - 14	18 - 14	18 - 14	18 - 14	18 - 14	18 - 14
---------	---------	---------	---------	---------	---------	---------	---------	---------	---------	---------

1.2

Contactors

Basic devices up to 170 A

1 DILM7 ... DILM170

				DILM7	DILM9	DILM12	DILM15	DILM17	DILM25
General									
Main cable connection screw/bolt				M3.5	M3.5	M3.5	M3.5	M5	M5
Tightening torque	Nm			1.2	1.2	1.2	1.2	3.2	3.2
Control circuit cable connection screw/bolt				M3.5	M3.5	M3.5	M3.5	M3.5	M3.5
Tightening torque	Nm			1.2	1.2	1.2	1.2	1.2	1.2
Tools									
Main conductors									
	Pozidriv screwdriver	Size		2	2	2	2	2	2
	Internal hexagon	mm	SW	–	–	–	–	–	–
	Flat-blade screwdriver	mm		0.8 x 5.5 1 x 6	0.8 x 5.5 1 x 6	0.8 x 5.5 1 x 6	0.8 x 5.5 1 x 6	0.8 x 5.5 1 x 6	0.8 x 5.5 1 x 6
Auxiliary conductors									
	Pozidriv screwdriver	Size		2	2	2	2	2	2
	Flat-blade screwdriver	mm		0.8 x 5.5 1 x 6	0.8 x 5.5 1 x 6	0.8 x 5.5 1 x 6	0.8 x 5.5 1 x 6	0.8 x 5.5 1 x 6	0.8 x 5.5 1 x 6
Terminal type spring-cage terminal									
Terminal capacity of main cable									
	Solid	mm ²		1 x (0.75 - 2.5) 2 x (0.75 - 2.5)				–	–
	Flexible	mm ²		1 x (0.75 - 2.5) 2 x (0.75 - 2.5)				–	–
	Flexible with ferrule	mm ²		1 x (0.75 - 1.5) 2 x (0.75 - 1.5)				–	–
	Flexible without ferrule	mm ²		1 x (0.75 - 2.5) 2 x (0.75 - 2.5)				–	–
	Solid or stranded	AWG		18 - 14	18 - 14	18 - 14	18 - 14	–	–
Terminal capacity of control circuit cable									
	Solid	mm ²		1 x (0.75 - 2.5) 2 x (0.75 - 2.5)					
	Flexible	mm ²		1 x (0.75 - 2.5) 2 x (0.75 - 2.5)					
	Flexible with ferrule	mm ²		1 x (0.75 - 1.5) 2 x (0.75 - 1.5)					
	Flexible without ferrule	mm ²		1 x (0.75 - 2.5) 2 x (0.75 - 2.5)				–	–
	Solid or stranded	AWG		18 - 14	18 - 14	18 - 14	18 - 14	18 - 14	18 - 14
Tools									
	Strip length	mm		10	10	10	10	10	10
	Screwdriver blade width	mm		3.5	3.5	3.5	3.5	3.5	3.5
Main contacts									
Rated impulse withstand voltage	U_{imp}	V AC		8000	8000	8000	8000	8000	8000
Overvoltage category/pollution degree				III/3	III/3	III/3	III/3	III/3	III/3
Rated insulation voltage	U_i	V AC		690	690	690	690	690	690
Rated operating voltage	U_e	V AC		690	690	690	690	690	690
Safe isolation according to EN 61140									
	Between coil and contacts	V AC		400	400	400	400	440	440
	Between the contacts	V AC		400	400	400	400	440	440
Making capacity (cos Φ to IEC/EN 60947)	To 690 V	A		112	112	144	155	238	350
Breaking capacity									
	230 V	A		70	90	120	124	170	250
	280/400 V	A		70	90	120	124	170	250
	500 V	A		50	70	100	100	170	250
	660/690 V	A		40	50	70	70	120	150
Short-circuit rating									
Short-circuit protection rating maximum fuse									
Type "2" coordination									
	400 V	gG/gL 500 V	A	20	20	20	20	35	35
	690 V	gG/gL 690 V	A	16	16	20	20	35	35
Type "1" coordination									
	400 V	gG/gL 500 V	A	35	35	35	63	63	100
	690 V	gG/gL 690 V	A	20	20	25	50	50	50

DILM32	DILM38	DILM40	DILM50	DILM65	DILM72	DILM80	DILM95	DILM115	DILM150	DILM170
M5	M5	M6	M6	M6	M6	M10	M10	M10	M10	M10
3.2	3.2	3.3	3.3	3.3	3.3	14	14	14	14	14
M3.5	M3.5	M3.5	M3.5	M3.5	M3.5	M3.5	M3.5	M3.5	M3.5	M3.5
1.2	1.2	1.2	1.2	1.2	1.2	1.2	1.2	1.2	1.2	1.2
2	2	2	2	2	2	–	–	–	–	–
–	–	–	–	–	–	5	5	5	5	5
0.8 x 5.5 1 x 6	0.8 x 5.5 1 x 6	0.8 x 5.5 1 x 6	0.8 x 5.5 1 x 6	0.8 x 5.5 1 x 6	0.8 x 5.5 1 x 6	–	–	–	–	–
2	2	2	2	2	2	2	2	2	2	2
0.8 x 5.5 1 x 6	0.8 x 5.5 1 x 6	0.8 x 5.5 1 x 6	0.8 x 5.5 1 x 6	0.8 x 5.5 1 x 6	0.8 x 5.5 1 x 6	0.8 x 5.5 1 x 6	0.8 x 5.5 1 x 6	0.8 x 5.5 1 x 6	0.8 x 5.5 1 x 6	0.8 x 5.5 1 x 6
–	–	–	–	–	–	–	–	–	–	–
–	–	–	–	–	–	–	–	–	–	–
–	–	–	–	–	–	–	–	–	–	–
–	–	–	–	–	–	–	–	–	–	–
–	–	–	–	–	–	–	–	–	–	–
1 x (0.75 - 2.5) 2 x (0.75 - 2.5)										
1 x (0.75 - 2.5) 2 x (0.75 - 2.5)										
1 x (0.75 - 1.5) 2 x (0.75 - 1.5)										
–	–	–	–	–	–	–	–	–	–	–
18 - 14	18 - 14	18 - 14	18 - 14	18 - 14	18 - 14	18 - 14	18 - 14	18 - 14	18 - 14	18 - 14
10	10	10	10	10	10	10	10	10	10	10
3.5	3.5	3.5	3.5	3.5	3.5	3.5	3.5	3.5	3.5	3.5
8000	8000	8000	8000	8000	8000	8000	8000	8000	8000	8000
III/3	III/3	III/3	III/3	III/3	III/3	III/3	III/3	III/3	III/3	III/3
690	690	690	690	690	690	690	690	690	690	690
690	690	690	690	690	690	690	690	690	690	690
440	440	440	440	440	440	690	690	690	690	690
440	440	440	440	440	440	690	690	690	690	690
384	384	560	700	910	910	1120	1330	1610	2100	2100
320	320	400	500	650	650	800	950	1150	1500	1500
320	320	400	500	650	650	800	950	1150	1500	1500
320	320	400	500	650	650	800	950	1150	1500	1500
180	180	250	320	370	370	650	800	1100	1200	1320
63	63	63	80	125	125	160	160	250	250	250
35	35	50	63	80	80	160	160	250	250	250
125	125	125	160	250	250	250	250	250	250	250
63	63	80	80	100	100	200	200	250	250	250

1.2

Contactors

Basic devices up to 170 A

1 DILM7 ... DILM170

				DILM7	DILM9	DILM12	DILM15	DILM17	DILM25	
AC voltage										
AC-1 operation										
Conventional free air thermal current 3 pole 50 - 60 Hz	Open	at 50 °C	I_{th}	A	22	22	22	22	40	45
		at 50 °C	I_{th}	A	21	21	21	21	38	43
		at 55 °C	I_{th}	A	21	21	21	21	37	42
		at 60 °C	I_{th}	A	20	20	20	20	35	40
	Enclosed		I_{th}	A	18	18	18	18	32	36
Conventional free air thermal current 1 pole	Open		I_{th}	A	50	50	50	50	88	100
	Enclosed		I_{th}	A	45	45	45	45	80	90
AC-3 operation										
Rated operational current AC -3 open, 50 - 60 Hz, 3 pole	220/230 V		I_e	A	7	9	12	15.5	18	25
	240 V		I_e	A	7	9	12	15.5	18	25
	380/400 V		I_e	A	7	9	12	15.5	18	25
	415 V		I_e	A	7	9	12	15.5	18	25
	440 V		I_e	A	7	9	12	15.5	18	25
	500 V		I_e	A	5	7	10	12.5	18	25
	660/690 V		I_e	A	4	5	7	9	12	15
Rated operational power	220/230 V	P	kW	2.2	2.5	3.5	4	5	7.5	
	240 V	P	kW	2.2	3	4	4.6	5.5	8.5	
	380/400 V	P	kW	3	4	5.5	7.5	7.5	11	
	415 V	P	kW	4	5.5	7	8	10	14.5	
	440 V	P	kW	4.5	5.5	7.5	8.4	10.5	15.5	
	500 V	P	kW	3.5	4.5	7	7.5	12	17.5	
	660/690 V	P	kW	3.5	4.5	6.5	7	11	14	
AC-4 operation										
Rated operational current AC-4 open, 50 - 60 Hz, 3 pole	220/230 V		I_e	A	5	6	7	7	10	13
	240 V		I_e	A	5	6	7	7	10	13
	380/400 V		I_e	A	5	6	7	7	10	13
	415 V		I_e	A	5	6	7	7	10	13
	440 V		I_e	A	5	6	7	7	10	13
	500 V		I_e	A	4.5	5	6	6	10	13
	660/690 V		I_e	A	4	4.5	5	5	8	10
Rated operational power	220/230 V	P	kW	1	1.5	2	2	2.5	3.5	
	240 V	P	kW	1.5	1.6	2.2	2.2	3	4	
	380/400 V	P	kW	2.2	2.5	3	3	4.5	6	
	415 V	P	kW	2.3	2.8	3.4	3.4	5	6.5	
	440 V	P	kW	2.4	3	3.6	3.6	5.5	7	
	500 V	P	kW	2.5	2.8	3.5	3.5	6	8	
	660/690 V	P	kW	2.9	3.6	4.4	4.4	6.5	8.5	
DC voltage										
Operations → Switching of DC current Page 92										
Rated operational current I_e open										
DC-1 operation	60 V		I_e	A	20	20	20	20	35	40
	110 V		I_e	A	20	20	20	20	35	40
	220 V		I_e	A	15	15	15	15	35	40
	440 V		I_e	A	1	1.3	1.3	1.3	2.9	2.9
DC-3 operation	660 V		I_e	A	20	20	20	20	35	35
	110 V		I_e	A	20	20	20	20	35	35
	220 V		I_e	A	1.5	1.5	1.5	1.5	10	10
	440 V		I_e	A	0.2	0.2	0.2	0.2	0.6	0.6
DC-5 operation	60 V		I_e	A	20	20	20	20	35	35
	110 V		I_e	A	20	20	20	20	35	35
	220 V		I_e	A	1.5	1.5	1.5	1.5	10	10
	440 V		I_e	A	0.2	0.2	0.2	0.2	0.6	0.6

DILM32	DILM38	DILM40	DILM50	DILM65	DILM72	DILM80	DILM95	DILM115	DILM150	DILM170
45	45	60	80	98	98	110	130	160	190	225
43	43	57	71	88	88	98	125	142	180	200
42	42	55	68	83	83	94	115	135	170	190
40	40	50	65	80	80	90	110	130	160	185
36	36	45	58	72	72	80	100	115	144	166
100	100	125	162	200	200	225	275	325	400	460
90	90	112	145	180	180	200	250	285	360	415
32	38	40	50	65	72	80	95	115	150	170
32	38	40	50	65	72	80	95	115	150	170
32	38	40	50	65	72	80	95	115	150	170
32	38	40	50	65	72	80	95	115	150	170
32	38	40	50	65	72	80	95	115	150	170
32	38	40	50	65	72	80	95	115	150	170
18	22.5	25	32	37	37	65	80	93	100	150
10	11	12.5	15.5	20	22	25	30	37	48	52
11	12	13.5	17	22	25	27.5	32	40	52	57
15	18.5	18.5	22	30	37	37	45	55	75	90
19	20	24	30	39	41	48	57	70	91	100
20	21	25	32	41	44	51	60	75	95	105
23	24	28	36	47	50	58	70	85	110	120
17	21	23	30	35	35	63	75	90	96	140
15	15	18	21	25	25	40	50	55	65	65
15	15	18	21	25	25	40	50	55	65	65
15	15	18	21	25	25	40	50	55	65	65
15	15	18	21	25	25	40	50	55	65	65
15	15	18	21	25	25	40	50	55	65	65
12	12	14	17	20	20	27	37	45	50	50
4	4	5	6	7	7	12	16	17	20	20
4.5	4.5	5.5	6.5	7.5	7.5	13	17	19	22	22
7	7	9	10	12	12	20	26	28	33	33
7.5	7.5	9.5	11	13	13	24	30	33	39	39
8	8	10	12	14	14	25	32	35	41	41
9	9	11	13	16	16	29	36	40	47	47
10	10	12	14	17	17	26	35	43	48	48
40	40	50	60	72	72	110	110	160	160	160
40	40	50	50	72	72	110	110	160	160	160
40	40	45	45	65	65	70	70	90	90	90
2.9	2.9	2.9	2.9	2.9	2.9	4.5	4.5	4.5	4.5	4.5
40	40	50	60	72	72	110	110	160	160	160
40	40	50	50	72	72	110	110	160	160	160
25	25	25	25	35	35	35	35	40	40	40
0.6	0.6	0.6	0.6	0.6	0.6	1	1	1	1	1
40	40	50	60	72	72	110	110	160	160	160
40	40	50	50	72	72	110	110	160	160	160
10	10	25	25	35	35	35	35	40	40	40
0.6	0.6	0.6	0.6	0.6	0.6	1	1	1	1	1

1 DILM7 ... DILM170

			DILM7	DILM9	DILM12	DILM15	DILM17	DILM25
Current heat loss (3 pole)								
Current heat loss at I_{th}	W		3	3	3	3	7.3	9.6
Current heat loss at I_e to AC-3/400 V	W		0.37	0.6	1.1	1.8	1.9	3.8
Impedance per pole	mΩ		2.5	2.5	2.5	2.5	2	2
Magnet systems								
Voltage tolerance								
AC operated	Pick-up	x U_c	0.8 - 1.1	0.8 - 1.1	0.8 - 1.1	0.8 - 1.1	0.8 - 1.1	0.8 - 1.1
AC operated	Drop-out	x U_c	0.3 - 0.6	0.3 - 0.6	0.3 - 0.6	0.3 - 0.6	0.3 - 0.6	0.3 - 0.6
DC operated ³⁾	Pick-up	x U_c	0.8 - 1.1	0.8 - 1.1 ¹⁾	0.8 - 1.1 ¹⁾	0.8 - 1.1 ¹⁾	0.7 - 1.2 ²⁾	0.7 - 1.2 ²⁾
DC operated ³⁾	Drop-out	x U_c	0.15 - 0.6	0.15 - 0.6	0.15 - 0.6	0.15 - 0.6	0.15 - 0.6	0.15 - 0.6
Power consumption of the coil in a cold state and 1.0 x U_c								
50 Hz	Pick-up	VA	24	24	24	24	52	52
50 Hz	Sealing	VA	3.4	3.4	3.4	3.4	7.1	7.1
50 Hz	Sealing	W	1.2	1.2	1.2	1.2	2.1	2.1
60 Hz	Pick-up	VA	30	30	30	30	67	67
60 Hz	Sealing	VA	4.4	4.4	4.4	4.4	8.7	8.7
60 Hz	Sealing	W	1.4	1.4	1.4	1.4	2.6	2.6
50/60 Hz	Pick-up	VA	27	27	27	27	62	62
			25	25	25	25	58	58
50/60 Hz	Sealing	VA	4.2	4.2	4.2	4.2	9.1	9.1
			3.3	3.3	3.3	3.3	6.5	6.5
50/60 Hz	Sealing	W	1.4	1.4	1.4	1.4	2.5	2.5
			1.2	1.2	1.2	1.2	2	2
DC operated	Pick-up	W	3	3	4.5	4.5	12	12
DC operated	Sealing	W	3	3	4.5	4.5	0.5	0.5
Duty factor	% DF		100	100	100	100	100	100
Changeover times at 100 % U_c (recommended values)								
Main contacts								
AC operated	Closing delay	ms	15...21	15...21	15...21	15...21	16...22	16...22
	Opening delay	ms	9...18	9...18	9...18	9...18	8...14	8...14
DC operated	Closing delay	ms	31	31	31	31	47	47
	Opening delay	ms	12	12	12	12	30	30
Arcing time								
Permissible residual current when A1 - A2 are actuated from the electronic system (with 0 signal)	mA		–	–	–	–	–	–
Lifespan, mechanical; Coil 50/60 Hz	At 50 Hz		Mechanical lifespan at 50 Hz approx. 30% lower than under → Technical data general					
Electromagnetic compatibility (EMC)								
Emitted interference	To EN 60947-1							
Interference immunity	To EN 60947-1							

Notes

¹⁾ At 24 V DC: 0.7 – 1.3 without auxiliary contact module and at ambient temperature + 40 °C

²⁾ RDC 24 (Umin 24 V DC/Umax 27 V DC)

RDC 60 (Umin 48 V DC/Umax 60 V DC)

RDC 130 (Umin 110 V DC/Umax 130 V DC)

RDC 240 (Umin 200 V DC/Umax 240 V DC)

Example: $U_c = 0.7 \times U_{min} - 1.2 \times U_{max} / U_c = 0.7 \times 24 \text{ V} - 1.2 \times 27 \text{ V DC}$

³⁾ At least: smoothed two-phase bridge rectifier or three-phase rectifier

DILM32	DILM38	DILM40	DILM50	DILM65	DILM72	DILM80	DILM95	DILM115	DILM150	DILM170
12.1	12.1	11.3	19	28.8	28.8	12.2	18.2	20.3	30.7	41.1
6.1	6.1	7.2	11.3	19	23	9.6	13.5	15.9	27	34.7
2	2	1.5	1.5	1.5	1.5	0.5	0.5	0.4	0.4	0.4
0.8 - 1.1	0.8 - 1.1	0.8 - 1.1	0.8 - 1.1	0.8 - 1.1	0.8 - 1.1	0.8 - 1.1	0.8 - 1.1	0.8 - 1.15	0.8 - 1.15	0.8 - 1.15
0.3 - 0.6	0.3 - 0.6	0.3 - 0.6	0.3 - 0.6	0.3 - 0.6	0.3 - 0.6	0.3 - 0.6	0.3 - 0.6	0.25 - 0.6	0.25 - 0.6	0.25 - 0.6
0.7 - 1.2 ²⁾	0.7 - 1.2 ²⁾	0.7 - 1.2 ²⁾	0.7 - 1.2 ²⁾	0.7 - 1.2 ²⁾	0.7 - 1.2 ²⁾	0.7 - 1.2 ²⁾	0.7 - 1.2 ²⁾	0.7 - 1.2 ²⁾	0.7 - 1.2 ²⁾	0.7 - 1.2 ²⁾
0.15 - 0.6	0.15 - 0.6	0.15 - 0.6	0.15 - 0.6	0.15 - 0.6	0.15 - 0.6	0.15 - 0.6	0.15 - 0.6	0.15 - 0.6	0.15 - 0.6	0.15 - 0.6
52	52	149	149	149	149	310	310	180	180	180
7.1	7.1	16	16	16	16	26	26	3.1	3.1	3.1
2.1	2.1	4.3	4.3	4.3	4.3	5.8	5.8	2.1	2.1	2.1
67	67	178	178	178	178	345	345	170	170	170
8.7	8.7	19	19	19	19	30	30	3.1	3.1	3.1
2.6	2.6	5.3	5.3	5.3	5.3	7.1	7.1	2.1	2.1	2.1
62	62	168	168	168	168	372	372	170	170	170
58	58	154	154	154	154	328	328	170	170	170
9.1	9.1	22	22	22	22	37.1	37.1	3.1	3.1	3.1
6.5	6.5	14	14	14	14	22.6	22.6	3.1	3.1	3.1
2.5	2.5	5.3	5.3	5.3	5.3	7.5	7.5	2.1	2.1	2.1
2	2	4.3	4.3	4.3	4.3	6.1	6.1	2.1	2.1	2.1
12	12	24	24	24	24	90	90	149	149	149
0.5	0.5	0.5	0.5	0.5	0.5	1.3	1.3	2.1	2.1	2.1
100	100	100	100	100	100	100	100	100	100	100
16...22	16...22	12...18	12...18	12...18	12...18	14...20	14...20	28...33	28...33	28...33
8...14	8...14	8...13	8...13	8...13	8...13	9...14	9...14	35...41	35...41	35...41
47	47	54	54	54	54	45	45	35	35	35
30	30	24	24	24	24	34	34	30	30	30
10	10	10	10	10	10	15	15	15	15	15
-	-	-	-	-	-	≤1	≤1	≤1	≤1	≤1

Mechanical lifespan at 50 Hz approx. 30% lower than under → Technical data general

To EN 60947-1

To EN 60947-1

1.2

Contactors

Comfort devices and standard devices greater than 170 A

1 DILM185...DILM1600, DILH

Contactors

DILM185A DILM225A DILM250 DILM300A DILM400 DILM500 DILM570

General									
Standards	IEC/EN 60947, VDE 0660, UL, CSA								
Lifespan, mechanical									
AC operated	c (contacts)	x 10 ⁶	10	10	10	10	7	7	7
DC operated	c (contacts)	x 10 ⁶	10	10	10	10	7	7	7
Operating frequency, mechanical									
AC operated	Operations/h		3000	3000	3000	3000	2000	2000	2000
DC operated	Operations/h		3000	3000	3000	3000	2000	2000	2000
Maximum operating frequency									
Electrical (Contactor without overload relay)	→ Engineering Page 91								
Climatic proofing									
Damp heat, constant, to IEC 60068-2-78									
Damp heat, cyclic, to IEC 60068-2-30									
Ambient temperature									
Open	°C		-25...60	-25...60	-25...60	-25...60	-25...60	-25...60	-25...60
Enclosed	°C		-25...40	-25...40	-25...40	-25...40	-25...40	-25...40	-25...40
Storage	°C		-40 - 80	-40 - 80	-40 - 80	-40 - 80	-40 - 80	-40 - 80	-40 - 80
Mounting position: AC and DC-actuated									
Mechanical shock resistance (IEC/EN 60068-2-27)									
Half-sinusoidal shock 10 ms									
Main contacts									
N/O	g		10	10	10	10	10	10	10
Auxiliary contacts									
N/O	g		10	10	10	10	10	10	10
NC	g		8	8	8	8	8	8	8
Protection type									
IP00 IP00 IP00 IP00 IP00 IP00 IP00 IP00									
Protection against direct contact when actuated from front (EN 90274)									
Finger- and back-of-hand proof with cover or terminal block									
Weight									
Weight	kg		3.2	3.2	6.5	6.5	8	8	8
Terminal capacity of main cable									
Flexible with cable lug	mm ²		50 - 185	50 - 185	50 - 240	50 - 240	50 - 240	50 - 240	50 - 240
Stranded with cable lug	mm ²		50 - 185	70 - 185	70 - 240	70 - 240	70 - 240	70 - 240	70 - 240
Solid or stranded	AWG		1/0 - 350	2/0 - 250	2/0 - 500	2/0 - 500	2/0 - 500	2/0 - 500	2/0 - 500
	MCM			MCM	MCM	MCM	MCM	MCM	MCM
Busbar	Width	mm	32	32	25	25	25	30	30
Main cable connection screw/bolt									
M10 M10 M10 M10 M10 M10 M10 M10									
Tightening torque									
Nm 24 24 24 24 24 24 24 24									
Terminal capacity of control circuit cable									
Solid	mm ²		1 x (0.75 - 2.5) 2 x (0.75 - 2.5)						
Flexible with ferrule	mm ²		1 x (0.75 - 2.5) 2 x (0.75 - 2.5)						
Solid or stranded	AWG		2 x (18 - 12)	2 x (18 - 12)	2 x (18 - 12)	2 x (18 - 12)	2 x (18 - 12)	2 x (18 - 12)	2 x (18 - 12)
Control circuit cable connection screw/bolt									
M3.5 M3.5 M3.5 M3.5 M3.5 M3.5 M3.5 M3.5									
Tightening torque									
Nm 1.2 1.2 1.2 1.2 1.2 1.2 1.2 1.2									
Tools									
Main conductors									
Wrench	mm		16	16	16	16	16	16	16
Auxiliary conductors									
Pozidriv screwdriver	Size		2	2	2	2	2	2	2

DILM580	DILM650	DILM750	DILM820	DILM1000	DILM1600	DILH1400	DILH2000	DILH2200	DILH2600
IEC/EN 60947, VDE 0660, UL, CSA									
5	5	5	5	5	5	5	5	5	5
5	5	5	5	5	5	5	5	5	5
1000	1000	1000	1000	1000	1000	1000	1000	1000	1000
1000	1000	1000	1000	1000	1000	1000	1000	1000	1000
→ Engineering Page 91									
Damp heat, constant, to IEC 60068-2-78									
Damp heat, cyclic, to IEC 60068-2-30									
-25...60	-25...60	-25...60	-25...60	-25...60	-25...60	-25...60	-25...60	-25...60	-25...60
-25...40	-25...40	-25...40	-25...40	-25...40	-25...40	-25...40	-25...40	-25...40	-25...40
-40 - 80	-40 - 80	-40 - 80	-40 - 80	-40 - 80	-40 - 80	-40 - 80	-40 - 80	-40 - 80	-40 - 80
10	10	10	10	10	10	10	10	10	10
10	10	10	10	10	10	10	10	10	10
8	8	8	8	8	8	8	8	8	8
IP00	IP00	IP00	IP00	IP00	IP00	IP00	IP00	IP00	IP00
Finger- and back-of-hand proof with cover or terminal block									
15	15	15	15	15	32	15	32	32	32
50 - 240	50 - 240	50 - 240	50 - 240	50 - 240	–	–	–	–	–
70 - 240	70 - 240	70 - 240	70 - 240	70 - 240	–	–	–	–	–
2/0 - 500 MCM	2/0 - 500 MCM	2/0 - 500 MCM	2/0 - 500 MCM	2/0 - 500 MCM	–	–	–	–	–
50	50	60	60	60	100	80	100	100	100
M10	M10	M12	M12	M12	M12	M12	M12	M12	M12
24	24	35	35	35	35	35	35	35	35
1 x (0.75 - 2.5)									
2 x (0.75 - 2.5)									
1 x (0.75 - 2.5)									
2 x (0.75 - 2.5)									
2 x (18 - 12)	2 x (18 - 12)	2 x (18 - 12)	2 x (18 - 12)	2 x (18 - 12)	2 x (18...12)	2 x (18 - 12)	2 x (18 - 12)	2 x (18 - 12)	2 x (18 - 12)
M3.5	M3.5	M3.5	M3.5	M3.5	M3.5	M3.5	M3.5	M3.5	M3.5
1.2	1.2	1.2	1.2	1.2	1.2	1.2	1.2	1.2	1.2
16	16	18	18	18	18	18	18	18	18
2	2	2	2	2	2	2	2	2	2

1.2

Contactors

Comfort devices and standard devices greater than 170 A

1 DILM185...DILM1600, DILH

Contactors

DILM185A DILM225A DILM250 DILM300A DILM400 DILM500 DILM570

Main contacts

			DILM185A	DILM225A	DILM250	DILM300A	DILM400	DILM500	DILM570
Rated impulse withstand voltage	U_{imp}	V AC	8000	8000	8000	8000	8000	8000	8000
Overvoltage category/pollution degree			III/3	III/3	III/3	III/3	III/3	III/3	III/3
Rated insulation voltage	U_i	V AC	1000	1000	1000	1000	1000	1000	1000
Rated operating voltage	U_e	V AC	1000	1000	1000	1000	1000	1000	1000
Safe isolation according to EN 61140									
Between coil and contacts		V AC	500	500	500	500	500	500	500
Between the contacts		V AC	500	500	500	500	500	500	500
Making capacity (cos Φ to IEC/EN 60947)		A	2700	2700	3000	3600	5500	5500	6000
Breaking capacity									
220/230 V		A	2250	2250	2500	3000	5000	5000	5800
380/440 V		A	2250	2250	2500	3000	5000	5000	5800
500 V		A	2250	2250	2500	3000	5000	5000	5800
660/690 V		A	2250	2250	2500	3000	5000	5000	5800
1000 V		A	760	760	760	950	950	950	950

Component lifespan → Page 87

Short-circuit rating

Short-circuit protection rating maximum fuse									
Type "2" coordination									
400 V	gG/gL 500 V	A	250	250	315	315	500	500	500
690 V	gG/gL 690 V	A	250	250	315	315	500	500	500
1000 V	gG/gL 1000 V	A	160	160	160	160	200	200	200
Type "1" coordination									
400 V	gG/gL 500 V	A	400	400	400	400	630	630	800
690 V	gG/gL 690 V	A	315	315	400	400	630	630	630
1000 V	gG/gL 1000 V	A	200	200	200	200	250	250	250

AC voltage

AC-1 operation

Conventional thermal current 3 pole 50 - 60 Hz									
Open									
at 40 °C	I_{th}	A	337	356	400	430	612	857	920
at 50 °C	I_{th}	A	301	310	360	385	548	767	821
at 55 °C	I_{th}	A	287	295	340	365	522	731	783
at 60 °C	I_{th}	A	275	285	330	350	500	700	750
Enclosed ¹⁾	I_{th}	A	245	275	300	315	450	650	–
Conventional thermal current, 1-pole									
Open ¹⁾	I_{th}	A	685	707	825	875	1250	1750	1875
Enclosed ¹⁾	I_{th}	A	625	636	742	785	1125	1600	–

AC-3 operation

Rated operational current AC -3 open, 50 – 60 Hz, 3 pole									
220/230 V	I_e	A	185	225	250	300	400	500	580
240 V	I_e	A	185	225	250	300	400	500	580
380/400 V	I_e	A	185	225	250	300	400	500	580
415 V	I_e	A	185	225	250	300	400	500	580
440 V	I_e	A	185	225	250	300	400	500	580
500 V	I_e	A	185	225	250	300	400	500	500
660/690 V	I_e	A	150	160	250	210	360	360	360
1000 V	I_e	A	76	76	76	95	95	95	95
Rated operational power									
220/230 V	P	kW	55	70	75	90	125	155	185
240 V	P	kW	62	75	85	100	132	170	200
380/400 V	P	kW	90	110	132	160	200	250	315
415 V	P	kW	110	132	148	180	240	300	348
440 V	P	kW	115	138	132	185	200	250	370
500 V	P	kW	132	160	180	215	290	360	360
660/690 V	P	kW	140	150	240	195	344	344	344
1000 V	P	kW	108	108	108	132	132	132	132

Notes

¹⁾ At maximum permissible ambient air temperature
²⁾ To 690 V

DILM580	DILM650	DILM750	DILM820	DILM1000	DILM1600	DILH1400	DILH2000	DILH2200	DILH2600
8000	8000	8000	8000	8000	8000	8000	8000	8000	8000
III/3	III/3	III/3	III/3	III/3	III/3	III/3	III/3	III/3	III/3
1000	1000	1000	1000	1000	1000	1000	1000	1000	1000
1000	1000	1000	1000	1000	1000	1000	1000	1000	1000
500	500	500	500	500	500	500	500	500	500
500	500	500	500	500	500	500	500	500	500
7800	7800	9840	9840	9840	19000	9840	9840	9840	9840
6500	6500	8200	8200	8200	16000	8200	8200	8200	8200
6500	6500	8200	8200	8200	16000	8200	8200	8200	8200
6500	6500	8200	8200	8200	16000	8200	8200	8200	8200
6500	6500	8200	8200	8200	16000	8200	8200	8200	8200
4350	4350	5800	5800	5800	5800	5800	5800	5800	5800
→ Page 87									
630	630	630	630	630	-	-	-	-	-
630	630	630	630	630	-	-	-	-	-
500	500	630	630	630	-	-	-	-	-
1000	1000	1200	1200	1200	-	-	-	-	-
1000	1000	1200	1200	1200	-	-	-	-	-
630	630	800	800	800	-	-	-	-	-
980	1041	1102	1225	1225	2200 ²⁾	1714 ²⁾	2450 ²⁾	2700 ²⁾	3185 ²⁾
876	931	986	1095	1095	1970 ²⁾	1533 ²⁾	2190 ²⁾	2400 ²⁾	2847 ²⁾
836	888	940	1044	1044	1880 ²⁾	1462 ²⁾	2089 ²⁾	2300 ²⁾	2716 ²⁾
800	850	900	1000	1000	1800 ²⁾	1400 ²⁾	2000 ²⁾	2200 ²⁾	2600 ²⁾
-	-	-	-	-	-	-	-	-	-
2000	2125	2250	2500	2500	4500	3500	5000	5500	6500 ²⁾
-	-	-	-	-	-	-	-	-	-
580	650	750	820	1000	1600	-	-	-	-
580	650	750	820	1000	1600	-	-	-	-
580	650	750	820	1000	1600	-	-	-	-
580	650	750	820	1000	1600	-	-	-	-
580	650	750	820	1000	1600	-	-	-	-
580	650	750	820	1000	1600	-	-	-	-
580	650	750	820	1000	1600	-	-	-	-
435	435	580	580	750	1200	-	-	-	-
185	205	240	260	315	500	-	-	-	-
200	225	260	285	340	550	-	-	-	-
315	355	400	450	560	900	-	-	-	-
348	390	455	500	610	930	-	-	-	-
370	420	480	450	650	1000	-	-	-	-
420	470	550	600	730	1180	-	-	-	-
560	630	720	750	1000	1600	-	-	-	-
600	600	800	800	1100	1770	-	-	-	-

1.2

Contactors

Comfort devices and standard devices greater than 170 A

1 DILM185...DILM1600, DILH

Contactors

DILM185A DILM225A DILM250 DILM300A DILM400 DILM500 DILM570

AC voltage

AC-4 operation

Rated operational current AC -4 open, 50 – 60 Hz, 3 pole			DILM185A	DILM225A	DILM250	DILM300A	DILM400	DILM500	DILM570
220/230 V	I_e	A	136	164	200	240	296	360	360
240 V	I_e	A	136	164	200	240	296	360	360
380/400 V	I_e	A	136	164	200	240	296	360	360
415 V	I_e	A	136	164	200	240	296	360	360
440 V	I_e	A	136	164	200	240	296	360	360
500 V	I_e	A	136	164	200	240	296	360	360
660/690 V	I_e	A	110	120	200	170	296	296	296
1000 V	I_e	A	55	55	76	76	95	95	95
Rated operational power			DILM185A	DILM225A	DILM250	DILM300A	DILM400	DILM500	DILM570
220/230 V	P	kW	41	51	62	75	92	112	112
240 V	P	kW	45	54	68	82	101	122	122
380/400 V	P	kW	75	90	110	132	160	200	200
415 V	P	kW	80	96	117	142	176	216	216
440 V	P	kW	85	102	125	150	186	229	229
500 V	P	kW	96	116	143	172	214	260	260
660/690 V	P	kW	102	110	189	160	283	344	344
1000 V	P	kW	77	77	108	109	132	132	132

Capacitor operation

Individual compensation rated operational current I_e of alternating current capacitor

Open			DILM185A	DILM225A	DILM250	DILM300A	DILM400	DILM500	DILM570
To 525 V		A	220	220	220	307	307	307	307
690 V		A	133	133	133	177	177	177	177
Max. peak inrush current	$x I_e$		30	30	30	30	30	30	30
Component lifespan	c (contacts)	$x 10^6$	0.1	0.1	0.1	0.1	0.1	0.1	0.1
Max. operating frequency		Ops/h	200	200	200	200	200	200	200

DC voltage

Operations

→ Engineering Page 92

Rated operational current I_e open

DC-1 operation			DILM185A	DILM225A	DILM250	DILM300A	DILM400	DILM500	DILM570
60 V	I_e	A	300	300	300	400	400	400	400
110 V	I_e	A	300	300	300	400	400	400	400
220 V	I_e	A	300	300	300	400	400	400	400
440 V	I_e	A	11	11	11	11	11	11	11
DC-3 operation			DILM185A	DILM225A	DILM250	DILM300A	DILM400	DILM500	DILM570
60 V	I_e	A	300	300	300	400	400	400	400
110 V	I_e	A	300	300	300	400	400	400	400
220 V	I_e	A	300	300	300	400	400	400	400
DC-5 operation			DILM185A	DILM225A	DILM250	DILM300A	DILM400	DILM500	DILM570
60 V	I_e	A	300	300	300	400	400	400	400
110 V	I_e	A	300	300	300	400	400	400	400
220 V	I_e	A	300	300	300	400	400	400	400

Current heat loss (3 pole)

Current heat loss at I_{th}	W	34	45	55	37	58	113	130
Current heat loss at I_e to AC-3/400 V	W	16	23	28	21	37	58	78

DILM580	DILM650	DILM750	DILM820	DILM1000	DILM1600	DILH1400	DILH2000	DILH2200	DILH2600
456	512	576	656	800	1280	-	-	-	-
456	512	576	656	800	1280	-	-	-	-
456	512	576	656	800	1280	-	-	-	-
456	512	576	656	800	1280	-	-	-	-
456	512	576	656	800	1280	-	-	-	-
456	512	576	656	800	1280	-	-	-	-
456	512	576	656	800	1280	-	-	-	-
348	348	464	464	700	1120	-	-	-	-
143	161	181	209	260	430	-	-	-	-
156	176	200	228	280	450	-	-	-	-
250	280	315	355	450	750	-	-	-	-
274	307	346	394	490	770	-	-	-	-
290	326	367	418	520	830	-	-	-	-
330	370	417	474	590	940	-	-	-	-
440	494	556	633	780	1300	-	-	-	-
509	509	678	678	1000	1650	-	-	-	-
463	463	463	463	463	-	-	-	-	-
265	265	265	265	265	-	-	-	-	-
30	30	30	30	30	-	-	-	-	-
0.1	0.1	0.1	0.1	0.1	-	-	-	-	-
200	200	200	200	200	-	-	-	-	-
-	-	-	-	-	-	-	-	-	-
-	-	-	-	-	-	-	-	-	-
-	-	-	-	-	-	-	-	-	-
-	-	-	-	-	-	-	-	-	-
-	-	-	-	-	-	-	-	-	-
-	-	-	-	-	-	-	-	-	-
-	-	-	-	-	-	-	-	-	-
-	-	-	-	-	-	-	-	-	-
-	-	-	-	-	-	-	-	-	-
-	-	-	-	-	-	-	-	-	-
-	-	-	-	-	-	-	-	-	-
-	-	-	-	-	-	-	-	-	-
61	69	78	96	96	155	188	192	232	250
32	41	54	65	96	123	-	-	-	-

1.2

Contactors

Comfort devices and standard devices greater than 170 A

DILM185...DILM1600, DILH

				Contactors						
				DILM185A	DILM225A	DILM250	DILM300A	DILM400	DILM500	DILM570
Magnet systems										
Voltage tolerance ¹⁾	AC operated	Pick-up	$x U_c$	0.8 - 1.15	0.8 - 1.15					
	AC operated	Drop-out	$x U_c$	0.25 - 0.6	0.25 - 0.6					
	DC operated	Pick-up	$x U_c$	0.7 - 1.2	0.7 - 1.2					
	DC operated	Drop-out	$x U_c$	0.15 - 0.6	0.15 - 0.6					
Power consumption of the coil in a cold state and $1.0 x U_c$	50/60 Hz	Pick-up	VA	210	210	–	–	–	–	–
	50/60 Hz	Sealing	VA	2.6	2.6	–	–	–	–	–
	50/60 Hz	Sealing	W	2.6	2.6	–	–	–	–	–
	DC operated	Pick-up	W	180	180	–	–	–	–	–
	DC operated	Sealing	W	2.1	2.1	–	–	–	–	–
Voltage tolerance	Comfort series DILM...	Pick-up	$x U_c$	–	–	$0.7 x U_{c\ min} - 1.15 x U_{c\ max}$				
	Standard range DILM...-S	Pick-up	$x U_c$	–	–	$0.85 x U_{c\ min} - 1.1 x U_{c\ max}$				
	Comfort series DILM...	Drop-out	$x U_c$	–	–	$0.2 x U_{c\ min} - 0.6 x U_{c\ min}$				
	Standard range DILM...-S	Drop-out	$x U_c$	–	–	$0.2 x U_{c\ min} - 0.4 x U_{c\ min}$				
Power consumption of the coil in a cold state and $1.0 x U_c$	Comfort series DILM...	Pick-up	VA	–	–	380 ²⁾	380 ²⁾	450 ²⁾	450 ²⁾	450 ²⁾
	Comfort series DILM...	Pick-up	W	–	–	250	250	350	350	350
	Comfort series DILM...	Sealing	VA	–	–	4.3	4.3	4.3	4.3	4.3
	Comfort series DILM...	Sealing	W	–	–	3.3	3.3	3.3	3.3	3.3
	Standard range DILM...-S	Pick-up	VA	–	–	360 ⁴⁾	360 ⁴⁾	715 ⁴⁾	715 ⁴⁾	715 ⁴⁾
	Standard range DILM...-S	Pick-up	W	–	–	325	625	645	645	645
	Standard range DILM...-S	Sealing	VA	–	–	4.3	4.3	4.3	4.3	4.3
	Standard range DILM...-S	Sealing	W	–	–	3.3	3.3	3.3	3.3	3.3
Duty factor			% DF	–	–	100	100	100	100	100
Changeover time at 100 % U_c (recommended values), main circuit										
Comfort series DILM...	Closing delay	ms		–	–	< 100	< 80	< 80	< 80	< 80
	Opening delay	ms		–	–	< 110	< 110	< 110	< 110	< 110
Standard range DILM...-S	Closing delay	ms		< 60	< 60	< 55	< 55	< 55	< 55	< 55
	Opening delay	ms		< 40	< 40	< 40	< 40	< 50	< 50	< 50
Behavior in limit range and transition area, hold state										
Voltage interruption	$(0 - 0.2 x U_{c\ min}) \leq 10\ ms$			–	–	Targeted bridging during this time				
	$(0 - 0.2 x U_{c\ min}) > 10\ ms$			Drop-out of the contactor						
Voltage drops	$(0 - 0.2 x U_{c\ min}) \leq 12\ ms$			Targeted bridging during this time						
	$(0.2 - 0.6 x U_{c\ min}) > 12\ ms$			Drop-out of the contactor						
	$(0.6 - 0.7 x U_{c\ min})$			Contactor remains switched on						
Excess voltage	$(1.15 - 1.3 x U_{c\ max})$			Contactor remains switched on						
	$(> 1.3 x U_{c\ max}) \leq 3\ s$			Contactor remains switched on						
	$(> 1.3 x U_{c\ max}) > 3\ s$			Drop-out of the contactor						
Pick-up phase	$(0.7 x U_{c\ min})$			Contactor does not switch on						
	$(0.7 x U_{c\ min} - 1.15 x U_{c\ max})$			Contactor switches on safely						
	$(> 1.15 x U_{c\ max})$			Contactor switches on safely						
Permissible transitional contact resistance (of external control unit when A11 is actuated)			m Ω	–	–	≤ 500	≤ 500	≤ 500	≤ 500	–
Permissible residual current (when A11 is actuated from the electronic system in the event of a 0 signal)			mA	–	–	≤ 1	≤ 1	≤ 1	≤ 1	–
PLC signal level (A3 - A4) to IEC/EN 61131-2 (part no. 2)										
High			V	15	15	15	15	15	15	–
Low			V	5	5	5	5	5	5	–

Electromagnetic compatibility (EMC)

Electromagnetic compatibility

This product is designed for operation in industrial environments (environment 2). The use in residential environments (environment 1) could cause electrical interference so that addition suppression must be planned.

Notes

- ¹⁾ $U_{c\ min}$, $U_{c\ max}$,
- ²⁾ Control transformer with $u_k \leq 0.6$
- ³⁾ Control transformer with $u_k \leq 0.7$
- ⁴⁾ $u_k \leq 10\ %$

1.2

Contactors

Basic devices up to 200 A, 4 pole

DILMP20 ... DILMP200

1

DILMP20 DILMP32 DILMP63 DILMP125
 DILMP45 DILMP80 DILMP160
 DILMP200

General					
Standards	IEC/EN 60947, VDE 0660, UL, CSA				
Lifespan, mechanical					
AC operated	c (contacts)	x 10 ⁶	10		
DC operated	c (contacts)	x 10 ⁶	10		
Operating frequency, mechanical					
Mechanical, AC operated	Operations/h		5000		3600
DC operated	Operations/h		5000		3600
Maximum operating frequency					
Electrical (Contactor without overload relay)	600				
Climatic proofing					
			Damp heat, constant, to IEC 60068-2-3		
			Damp heat, cyclic, to IEC 60068-2-30		
Ambient temperature					
Open	°C	-25...60			
Enclosed	°C	-25...40			
Storage	°C	-40 - 80			
Mounting position AC- and DC operated					
Mechanical shock resistance (IEC/EN 60068-2-27)					
Half-sinusoidal shock 10 ms					
Main contacts					
	N/O	g	10		
Auxiliary contacts					
	N/O	g	7		
	NC	g	5		
Protection type					
			IP20	IP00	
With accessories					
			–	IP20	
Protection against direct contact when actuated from front (EN 50274)					
			Finger- and back-of-hand proof		
Terminal type, screw connection					
Terminal capacity of main cable					
Solid		mm ²	1 x (0.75 - 4) 2 x (0.75 - 2.5)	1 x (0.75 - 16) 2 x (0.75 - 10)	1 x (2.5 - 16) 2 x (2.5 - 16)
Flexible with ferrule		mm ²	1 x (0.75 - 2.5) 2 x (0.75 - 2.5)	1 x (0.75 - 16) 2 x (0.75 - 10)	1 x (2.5 - 35) 2 x (2.5 - 25)
Stranded		mm ²	–	1 x 16	1 x (16 - 50) 2 x (16 - 35)
Solid or stranded		AWG	18 - 14	18 - 6	12 - 2
Flat conductor	Number of layers x width x thickness	mm	–	–	2 x (6 x 9 x 0.8) 2 x (6 x 16 x 0.8)
Terminal capacity of control circuit cable					
Solid		mm ²	1 x (0.75 - 4) 2 x (0.75 - 2.5)	1 x (0.75 - 4) 2 x (0.75 - 2.5)	1 x (0.75 - 4) 2 x (0.75 - 4)
Flexible with ferrule		mm ²	1 x (0.75 - 2.5) 2 x (0.75 - 2.5)	1 x (0.75 - 2.5) 2 x (0.75 - 2.5)	1 x (0.75 - 2.5) 2 x (0.75 - 2.5)
Solid or stranded		AWG	18 - 14	18 - 14	18 - 14
Main cable connection screw/bolt					
			M3.5	M5	M6
Tightening torque					
		Nm	1.2	3	3.3
Control circuit cable connection screw/bolt					
			M3.5	M3.5	M3.5
Tightening torque					
		Nm	1.2	1.2	1.2
Tools					
Main conductors					
Pozidriv screwdriver		Size	2	2	2
Internal hexagon	SW	mm	–	–	5
Flat-blade screwdriver		mm	0.8 x 5.5 1 x 6	0.8 x 5.5 1 x 6	0.8 x 5.5 1 x 6
Auxiliary conductors					
Pozidriv screwdriver		Size	2	2	2
Flat-blade screwdriver		mm	0.8 x 5.5 1 x 6	0.8 x 5.5 1 x 6	0.8 x 5.5 1 x 6

DILMP20 ... DILMP200

				DILMP20	DILMP32 DILMP45	DILMP63 DILMP80	DILMP125 DILMP160	DILMP200				
Main contacts												
Rated impulse withstand voltage	U_{imp}	V AC		8000								
Overvoltage category/pollution degree				III/3								
Rated insulation voltage	U_i	V AC		690								
Rated operating voltage	U_e	V AC		690								
Safe isolation according to EN 61140												
	Between coil and contacts		V AC	400	440							
	Between the contacts		V AC	400	440							
Making capacity (cos φ to IEC/EN 60947)	To 690 V	A		144	238	350	560	700	1120	1330	1800	
Breaking capacity												
	220/230 V	A		120	180	250	400	500	800	950	1150	
	380/400 V	A		120	180	250	400	500	800	950	1150	
	500 V	A		100	180	250	400	500	800	950	1150	
	660/690 V	A		70	120	144	250	296	650	750	800	
Short-circuit rating												
Short-circuit protection rating maximum fuse												
Type "2" coordination												
	400 V	gG/gL 500 V	A	20	35	35	63	80	160	160	250	
	690 V	gG/gL 690 V	A	20	35	35	50	63	160	160	200	
Type "1" coordination												
	400 V	gG/gL 500 V	A	35	63	100	125	160	250	250	250	
	690 V	gG/gL 690 V	A	25	50	50	80	80	200	200	200	
AC voltage												
AC-1 operation												
Conventional thermal current 3 pole 50 - 60 Hz												
	Open	at 40 °C	I_{th}	A	22	32	45	63	80	125	160	200
		at 50 °C	I_{th}	A	21	30	41	60	76	116	150	188
		at 60 °C	I_{th}	A	20	28	39	54	69	108	138	172
	Enclosed		I_{th}	A	18	27	36	50	64	100	128	160
Conventional thermal current, 1 pole												
	Open		I_{th}	A	60	84	117	162	207	325	415	516
	Enclosed		I_{th}	A	54	76	105	146	186	292	373	464
Rated operational power												
	220/230 V	P	kW	8	12	16	23	29	45	58	72	
	240 V	P	kW	9	13	18	25	32	49	63	79	
	380 V	P	kW	14	20	28	39	50	78	100	125	
	415 V	P	kW	15	22	31	43	55	85	109	137	
	440 V	P	kW	16	23	33	46	58	90	116	145	
	500 V	P	kW	18	26	37	52	66	103	132	165	
	690 V	P	kW	24	35	49	68	87	136	174	217	
AC-3 operation												
Rated operational current AC -3 open, 50 – 60 Hz, 3 pole												
	220/230 V	I_e	A	12	18	25	40	50	80	95	115	
	240 V	I_e	A	12	18	25	40	50	80	95	115	
	380/400 V	I_e	A	12	18	25	40	50	80	95	115	
	415 V	I_e	A	12	18	25	40	50	80	95	115	
	440 V	I_e	A	12	18	25	40	50	80	95	115	
	500 V	I_e	A	10	18	25	40	50	80	95	115	
	660/690 V	I_e	A	7	12	15	25	32	65	80	93	
Rated operational power												
	220/230 V	P	kW	3.5	5	7.5	12.5	15.5	25	30	37	
	240 V	P	kW	4	5.5	8.5	13.5	17	27.5	33	40	
	380/400 V	P	kW	5.5	7.5	11	18.5	22	37	45	55	
	415 V	P	kW	7	10	14.5	24	30	48	57	70	
	440 V	P	kW	7.5	10.5	15.5	25	32	51	60	75	
	500 V	P	kW	7	12	17.5	28	36	58	70	85	
	660/690 V	P	kW	6.5	11	14	23	30	63	75	90	

1.2

Contactors

Basic devices up to 200 A, 4 pole

1 DILMP20 ... DILMP200

				DILMP20	DILMP32		DILMP63		DILMP125		
					DILMP45		DILMP80		DILMP160		
									DILMP200		
DC voltage											
Rated operational current I_e open											
DC-1 operation											
60 V	I_e	A	22	32	45	63	80	125	160	200	
110 V	I_e	A	22	32	45	63	80	125	160	200	
220 V	I_e	A	6	32	45	63	80	125	160	200	
440 V	I_e	A	1.3	3	3	5	5	10	10	10	
DC-3 operation											
60 V	I_e	A	20	32	45	63	80	125	160	200	
110 V	I_e	A	20	32	45	63	80	125	160	200	
220 V	I_e	A	1.5	32	45	63	80	125	160	200	
440 V	I_e	A	0.2	6	6	8	8	9	9	9	
DC-5 operation											
60 V	I_e	A	20	32	45	63	80	125	160	200	
110 V	I_e	A	20	25	32	50	80	125	160	200	
220 V	I_e	A	1.5	15	22	38	70	100	125	150	
440 V	I_e	A	0.2	4	4	8	8	8	8	8	
Current heat loss (3 pole)											
Current heat loss at I_{th}			W	4.7	8.2	12	16	23	29	46	60
Impedance per pole			m Ω	2.5	2	1.5	1	0.7	0.6	0.6	0.5
Magnet systems											
Voltage tolerance											
AC operated 50 Hz	Pick-up	$x U_c$	0.8 - 1.1	0.8 - 1.1	0.8 - 1.1	0.8 - 1.1	0.8 - 1.1	0.8 - 1.1	0.8 - 1.1	0.8 - 1.1	
AC operated 50/60 Hz		$x U_c$	0.8 - 1.1	0.85 - 1.1	0.85 - 1.1	0.85 - 1.1	0.85 - 1.1	0.85 - 1.1	0.85 - 1.1	0.85 - 1.1	
AC operated	Drop-out	$x U_c$	0.4 - 0.6	0.4 - 0.6	0.4 - 0.6	0.4 - 0.6	0.4 - 0.6	0.4 - 0.6	0.4 - 0.6	0.4 - 0.6	
DC operated ¹⁾	Pick-up	$x U_c$	0.8 - 1.1	0.7 - 1.2	0.7 - 1.2	0.7 - 1.2	0.7 - 1.2	0.7 - 1.2	0.7 - 1.2	0.7 - 1.2	
DC operated ¹⁾	Drop-out	$x U_c$	0.2 - 0.6	0.2 - 0.6	0.2 - 0.6	0.2 - 0.6	0.2 - 0.6	0.2 - 0.6	0.2 - 0.6	0.2 - 0.6	
Power consumption of the coil in a cold state and $1.0 x U_c$											
AC operated 50/60 Hz	Pick-up	VA	24	50	150	180	180	180	180	180	
AC operated 50/60 Hz	Pick-up	W	19	40	95	150	150	150	150	150	
AC operated 50/60 Hz	Sealing	VA	4	8	16	3.1	3.1	3.1	3.1	3.1	
AC operated 50/60 Hz	Sealing	W	1.2	2.4	4	2.1	2.1	2.1	2.1	2.1	
DC operated ¹⁾	Pick-up	W	4.5	12	24	149	149	149	149	149	
DC operated ¹⁾	Sealing	W	4.5	0.5	0.5	2.1	2.1	2.1	2.1	2.1	
Duty factor			% DF	100	100	100	100	100	100	100	
Changeover times at 100 % U_c (recommended values)											
Main contacts											
AC operated											
	Closing delay	ms	15...21	16...22	12...18	28...33	28...33	28...33	28...33	28...33	
	Opening delay	ms	9...18	8...14	8...13	35...41	35...41	35...41	35...41	35...41	
DC operated ¹⁾											
	Closing delay	ms	31	47	54	35	35	35	35	35	
	Opening delay	ms	12	30	24	30	30	30	30	30	
Arcing time											
	Permissible residual current when A1 - A2 are actuated from the electronic system (with 0 signal)	mA	≤ 1	≤ 1	≤ 1	≤ 1	≤ 1	≤ 1	≤ 1	≤ 1	

Notes

¹⁾ At least double-pulse bridge rectifier

DILK

			DILK12	DILK20	DILK25	DILK33	DILK50	
General								
Standards			IEC/EN 60947, VDE 0660					
Ambient temperature								
Open	°C		-25...60	-25...60	-25...60	-25...60	-25...60	
Enclosed	°C		-25...40	-25...40	-25...40	-25...40	-25...40	
Mounting position								
Protection type			IP00	IP00	IP00	IP00	IP00	
Protection against direct contact when actuated from front (EN 50274)			Finger- and back-of-hand proof					
Weight basic device								
AC operated	kg		0.55	0.55	0.55	1	1	
Terminal capacity of main cable								
Solid	mm ²		1 x (0.75 - 16)	1 x (0.75 - 16)	1 x (0.75 - 16)	1 x (2.5 - 16)	1 x (2.5 - 16)	
Flexible with ferrule	mm ²		1 x (0.75 - 16)	1 x (0.75 - 16)	1 x (0.75 - 16)	1 x (2.5 - 35)	1 x (2.5 - 35)	
Stranded	mm ²		1 x 16	1 x 16	1 x 16	1 x (16 - 50)	1 x (16 - 50)	
Solid or stranded	AWG		18 - 16	18 - 6	18 - 6	12 - 2	12 - 2	
Flat conductor	Number of layers x width x thickness	mm	-	-	-	1 x (6 x 9 x 0.8)	1 x (6 x 9 x 0.8)	
Group compensation								
60 Hz								
230 V	kvar		7.5	11	15	20	25	
400 V	kvar		12.5	20	25	33.3	50	
525 V	kvar		16.7	25	33.3	40	65	
690 V	kvar		20	33.3	40	55	85	
50/60 Hz								
Open								
230 V	I_e	A	18	29	38	50	72	
400 V	I_e	A	18	29	38	50	72	
525 V	I_e	A	18	29	38	50	72	
690 V	I_e	A	18	29	38	50	72	
Enclosed								
230 V	I_e	A	16	26	34	45	65	
400 V	I_e	A	16	26	34	45	65	
525 V	I_e	A	16	26	34	45	65	
690 V	I_e	A	16	26	34	45	65	
Making capacity (i-peak value) without damping			x I_e	180	180	180	180	180
Component lifespan			c (contacts) x 10 ⁶	0.15	0.15	0.15	0.15	0.15
Maximum operating frequency			Ops/h	120	120	120	120	120

1.2

Contactors

Contactor for capacitors

1 DILK

			DILK12	DILK20	DILK25	DILK33	DILK50
Magnet systems							
Voltage tolerance							
AC operated	Pick-up	$x U_c$	0.8 - 1.1	0.8 - 1.1	0.8 - 1.1	0.8 - 1.15	0.8 - 1.15
AC operated	Drop-out	$x U_c$	0.3 - 0.6	0.3 - 0.6	0.3 - 0.6	0.3 - 0.6	0.3 - 0.6
Power consumption of the coil in a cold state and $1.0 x U_c$							
50 Hz	Pick-up	VA	58	58	58	45	45
50 Hz	Sealing	VA	7.6	7.6	7.6	1.5	1.5
50 Hz	Sealing	W	2.3	2.3	2.3	1.5	1.5
60 Hz	Pick-up	VA	71	71	71	45	45
60 Hz	Sealing	VA	9.3	9.3	9.3	1.5	1.5
60 Hz	Sealing	W	2.8	2.8	2.8	1.5	1.5
50/60 Hz	Pick-up	VA	65	65	65	45	45
			59	59	59	45	45
50/60 Hz	Sealing	VA	9.6	9.6	9.6	1.5	1.5
			7	7	7	1.5	1.5
50/60 Hz	Sealing	W	2.7	2.7	2.7	1.5	1.5
			2.2	2.2	2.2	1.5	1.5
Duty factor		% DF	100	100	100	100	100
Changeover times at 100 % U_c (recommended values)							
Main contacts							
AC operated							
	Closing delay	ms	16...22	16...22	16...22	50	50
	Opening delay	ms	8...14	8...14	8...14	40	40
Arcing time		ms	10	10	10	10	10
Electromagnetic compatibility (EMC)							
Emitted interference			To EN 60947-1	To EN 60947-1	To EN 60947-1	To EN 60947-1	To EN 60947-1
Interference immunity			To EN 60947-1	To EN 60947-1	To EN 60947-1	To EN 60947-1	To EN 60947-1
Further technical data							
As per contactor	DIL		M17	M25	M32	M50	M65

DILL

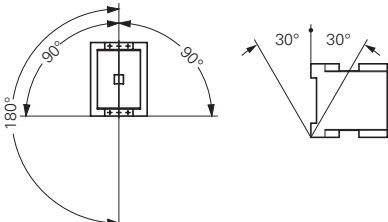
				DILL12	DILL18	DILL20
General						
Standards				IEC/EN 60947, VDE 0660, UL, CSA		
Lifespan, mechanical						
AC operated		c (contacts)	x 10 ⁶	1	1	1
Operating frequency, mechanical						
Mechanical, AC operated		Operations/h		60	60	60
Maximum operating frequency						
Electrical		Operations/h		60	60	60
Climatic proofing				Damp heat, constant, to IEC 60068-2-78; Damp heat, cyclic, to IEC 60068-2-30		
Ambient temperature	Open	°C		-25...60	-25...60	-25...60
	Enclosed	°C		-25...40	-25...40	-25...40
	Storage	°C		-40 - 80	-40 - 80	-40 - 80
Mounting position						
Mechanical shock resistance (IEC/EN 60068-2-27)						
Half-sinusoidal shock 10 ms				6.9	6.9	6.9
Protection type				IP00	IP00	IP00
Weight						
AC operated		kg		0.42	0.42	0.42
Main contacts						
Rated impulse withstand voltage		U _{imp}	V AC	8000	8000	8000
Overvoltage category/pollution degree				III/3	III/3	III/3
Rated insulation voltage		U _i	V AC	690	690	690
Rated operating voltage		U _e	V AC	690	690	690
Making capacity				A 238	350	550
Breaking capacity		380/400 V		A 170	250	320
Lifespan, electrical		c (contacts)		10000	10000	10000
Short-circuit protection rating maximum fuse						
400 V		gG/gL 500 V		A 63	100	125
AC voltage						
AC-1 operation						
Conventional thermal current						
at 40 °C		I _{th}	A	27	40	45
at 60 °C		I _{th}	A	24	35	40
230 V		I _e	A	12	18	20
400 V		I _e	A	12	18	20
AC-1 operation						
220/230 V		I _e	A	14	21	27
400 V		I _e	A	14	21	27
Electric lamps						
Filament bulbs				A 14	21	27
Mercury blended lamps				A 12	16	23
Fluorescent lamp load						
Conventional reactor starter connection				A 20	26	35
Duo circuit				A 20	26	35
Electronic upstream devices				A 12	18	20
High-pressure mercury vapour lamps				A 12	18	20
Metal-halide lamps				A 12	18	20
High-pressure sodium lamps				A 12	18	20
Low-pressure sodium lamps				A 7.5	10	12
Maximum permissible compensation capacitance		µF		470	470	470
Further technical data						
As per contactor		DIL		M17	M25	M32

1.2

Contactors

Contactors up to 150 A with electronic actuation

1 DILMF

DILMF8 DILMF11 DILMF14 DILMF17

General
Mounting position

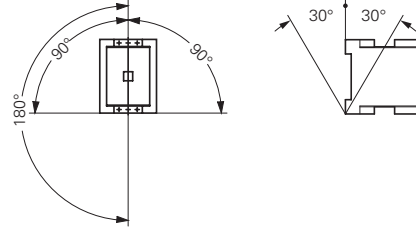

AC voltage

AC-3 operation

Rated operational current AC -3 open, 50 – 60 Hz, 3 pole	220/230 V	I_e	A	7	9	12	18
	240 V I	I_e	A	7	9	12	18
	380/400 V	I_e	A	7	9	12	18
	415 V	I_e	A	7	9	12	18
	440 V	I_e	A	7	9	12	18
	500 V	I_e	A	5	7	10	18
	660/690 V	I_e	A	4	5	7	12
Rated operational power	220/230 V	P	kW	2.2	2.5	3.5	5
	240 V	P	kW	2.2	3	4	5.5
	380/400 V	P	kW	3	4	5.5	7.5
	415 V	P	kW	4	5.5	7	10
	440 V	P	kW	4.5	5.5	7.5	10.5
	500 V	P	kW	3.5	4.5	7	12
	660/690 V	P	kW	3.5	4.5	6.5	11

AC-4 operation

Rated operational current AC-4 open, 50 - 60 Hz, 3 pole	220/230 V I	I_e	A	5	6	7	10
	240 V	I_e	A	5	6	7	10
	380/400 V	I_e	A	5	6	7	10
	415 V	I_e	A	5	6	7	10
	440 V	I_e	A	5	6	7	10
	500 V	I_e	A	4.5	5	6	10
	660/690 V	I_e	A	4	4.5	5	8
Rated operational power	220/230 V	P	kW	1	1.5	2	2.5
	240 V	P	kW	1.5	1.6	2.2	3
	380/400 V	P	kW	2.2	2.5	3	4.5
	415 V	P	kW	2.3	2.8	3.4	5
	440 V	P	kW	2.4	3	3.6	5.5
	500 V	P	kW	2.5	2.8	3.5	6
	660/690 V	P	kW	2.9	3.6	4.4	6.5

Current heat loss (3 pole)

Current heat loss at I_{th}		W	2.4	2.4	2.4	7.3
Current heat loss at I_e to AC-3/400 V		W	0.3	0.6	1	1.9

Magnet systems

Voltage tolerance	AC operated	Pick-up	$x U_c$	0.8 - 1.15	0.8 - 1.15	0.8 - 1.15	0.8 - 1.15
	AC operated	Drop-out	$x U_c$	0.2 - 0.5	0.2 - 0.5	0.2 - 0.5	0.2 - 0.5
Power consumption of the coil in a cold state and $1.0 \times U_c$	Electronic actuation	Pick-up	VA	14	14	14	14
	Electronic actuation	Sealing	VA	0.7	0.7	0.7	0.7
	Electronic actuation	Sealing	W	0.7	0.7	0.7	0.7
Duty factor		% DF	100	100	100	100	
Switching times	Closing delay	ms	40	40	40	40	
	Opening delay	ms	45	45	45	45	

suitable according to SEMI F47 SEMI F47 SEMI F47 SEMI F47

Electromagnetic compatibility (EMC)

Emitted interference To EN 60947-1

Interference immunity To EN 60947-1

Further technical data

As per contactor DIL M7 M9 M12 M17

Terminal type

As per contactor DIL M17 M17 M17 M17

DILMF25	DILMF32	DILMF40	DILMF50	DILMF65	DILMF80	DILMF95	DILMF115	DILMF150
---------	---------	---------	---------	---------	---------	---------	----------	----------

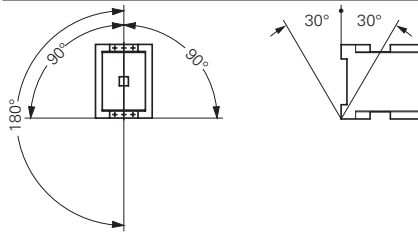

25	32	40	50	65	80	95	115	150
25	32	40	50	65	80	95	115	150
25	32	40	50	65	80	95	115	150
25	32	40	50	65	80	95	115	150
25	32	40	50	65	80	95	115	150
15	18	25	32	37	65	80	93	100
7.5	10	12.5	15.5	20	25	30	37	48
8.5	11	13.5	17	22	27.5	4	40	52
11	15	18.5	22	30	37	45	55	75
14.5	19	24	30	39	48	57	70	91
15.5	20	25	32	41	51	60	75	95
17.5	23	28	36	47	58	70	85	110
14	17	23	30	35	63	75	90	96

13	15	18	21	25	40	50	55	65
13	15	18	21	25	40	50	55	65
13	15	18	21	25	40	50	55	65
13	15	18	21	25	40	50	55	65
13	15	18	21	25	40	50	55	65
13	15	18	21	25	40	50	55	65
10	12	14	17	20	27	37	45	50
3.5	4	5	6	7	12	16	17	20
4	4.5	5.5	6.5	7.5	13	17	19	22
6	7	9	10	12	20	26	28	33
6.5	7.5	9.5	11	13	24	30	33	39
7	8	10	12	14	25	32	35	41
8	9	11	13	16	29	36	40	47
8.5	10	12	14	17	26	35	43	48

9.6	12.1	11.3	19	28.8	14.6	21.8	30.4	46.1
3.8	6.1	7.2	11.3	19	11.5	16.2	23.8	40.5

0.8 - 1.15	0.8 - 1.15	0.8 - 1.15	0.8 - 1.15	0.8 - 1.15	0.8 - 1.15	0.8 - 1.15	0.8 - 1.15	0.8 - 1.15
0.2 - 0.5	0.2 - 0.5	0.2 - 0.5	0.2 - 0.5	0.2 - 0.5	0.2 - 0.5	0.2 - 0.5	0.2 - 0.5	0.2 - 0.5
14	14	45	45	45	75	75	180	180
0.7	0.7	1.5	1.5	1.5	2	2	3.1	3.1
0.7	0.7	1.5	1.5	1.5	2	2	2.1	2.1
100	100	100	100	100	100	100	100	100
40	40	50	50	50	55	55	40	40
45	45	45	45	45	40	40	40	40
SEMI F47	SEMI F47	SEMI F47	SEMI F47	SEMI F47	SEMI F47	SEMI F47	SEMI F47	SEMI F47

To EN 60947-1

To EN 60947-1

M25	M32	M40	M50	M65	M80	M95	M115	M150
-----	-----	-----	-----	-----	-----	-----	------	------

M25	M32	M40	M50	M65	M80	M95	M115	M150
-----	-----	-----	-----	-----	-----	-----	------	------

1.2

Contactors

Auxiliary contact modules

1 DILM..., DILA...

			DILM7-... - DILM38-...	DILA- XHI(C)...(-S)	DILM32- XHI(C)...(-S)	DILM150- XHI...	DILM1000-XHI... DILM820-XHI...
Auxiliary contact							
Interlocked opposing contacts within an auxiliary contact module (to IEC 60947-5-1 Annex L) ¹⁾			-	Yes	Yes	Yes	Yes
Normally closed (not late-normally closed) suitable as a mirror contact (to IEC/EN 60947-4-1, Annex F)			DILM7 - DILM38	DILM7 - DILM38	DILM7 - DILM38	DILM40 - DILM170	DILM40 - DILM225A DILM250 - DILM1000
Rated impulse withstand voltage	U _{imp}	V AC	6000	6000	6000	6000	6000
Overvoltage category/pollution degree			III/3	III/3	III/3	III/3	III/3
Rated insulation voltage	U _i	V AC	690	690	690	690	690
Rated operating voltage	U _e	V AC	500	500	500	500	500
Safe isolation according to EN 61140							
Between coil and auxiliary contacts		V AC	400	400	400	440	440
Between the auxiliary contacts		V AC	400	400	400	440	440
Rated operational current							
AC-15							
	230 V	I _e	A	4	4	4	4
	380/415 V	I _e	A	4	4	4	4
	500 V	I _e	A	1.5	–	1.5	1.5
DC L/R ≅ 15 ms ²⁾							
	24 V	I _e	A	10	10	10	10
	60 V	I _e	A	6	6	6	6
	110 V	I _e	A	3	3	3	3
	220 V	I _e	A	1	1	1	1
DC-13 (6xP)							
Contacts in series:							
	3	24 V	A	2.5	2.5	2.5	–
	3	60 V	A	1	1	1	–
	3	110 V	A	0.5	0.5	0.5	–
	3	220 V	A	0.25	0.25	0.25	–
Conventional thermal current	I _{th}	A	10	16	16	16	10
Control circuit reliability (at U _e = 24 V DC, U _{min} = 17 V, I _{min} = 5.4 mA)	Fault probability	λ	< 10 ⁻⁹ , < 1 one failure in 100 million operations				
Component lifespan							
at U _e = 230 V, AC-15, 3 A		c (contacts)	x 10 ⁶	1.3	1.3	1.3	1.3
Short-circuit rating without welding							
Max. fuse		A gG/gL	10	10	10	16	16

Notes

¹⁾ Not with DIL...-XHIV and DIL...-XHICV.

²⁾ Switch-on and switch-off conditions based on DC-13, time constant as specified.

P1SIL...M, DILM...-XP1

1

			P1DILEM DILM12-XP1	DILM32-XP1	DILM65-XP1	DILM150-XP1	DILM185-XP1
Parallel connector							
Terminal capacity							
Solid		mm ²	1 - 16	16	16	–	–
Flexible with ferrule		mm ²	1 x (0.5 - 25) 2 x (0.5 - 16)	1 x (16 - 35)	1 x (16 - 120)	–	–
Stranded		mm ²	1 x (0.5 - 25) 2 x (0.5 - 16)	1 x (16 - 50)	1 x (16 - 120)	1 x (35 - 300) 2 x (35 - 120)	–
Flat conductor	Number of layers x width x thickness	mm	6 x 9 x 0.8	–	–	2 x (11 x 21 x 1)	1 x (6 x 16 x 0.8) 2 x (20 x 32 x 0.5) 2 x (11 x 21 x 1)
Tightening torque		Nm	4	4	14	14	6
Terminal capacity of control circuit cable							
Solid		mm ²	–	–	–	–	1 x (0.75 - 4) 2 x (0.75 - 4)
Flexible with ferrule		mm ²	–	–	–	–	1 x (0.75 - 2.5) 2 x (0.75 - 2.5)
Tools							
Pozidriv screwdriver		Size	2	2	–	–	–
Internal hexagon	SW	mm	–	–	5	6	5
Conventional thermal current							
3 pole	I _{th}	A	50	100	180	400	700
4 pole	I _{th}	A	60	–	–	–	–

1.2

Contactors

Minicontactor relay, contactor combination

Dimensions

1 Mini contactor relays

DILER...(-C)
DILER...-G(-C)

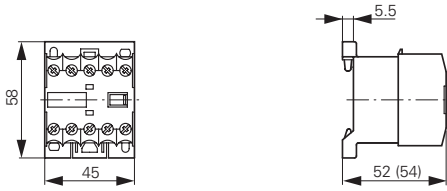

DILER...(-C) + ...DILE(-C)
DILER...-G(-C) + ...DILE(-C)

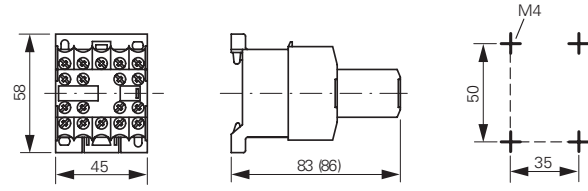

DILEEM..., DILEM...(-C), DILEM-12...
DILEEM...-G, DILEM...-G(-C), DILEM-12...-G

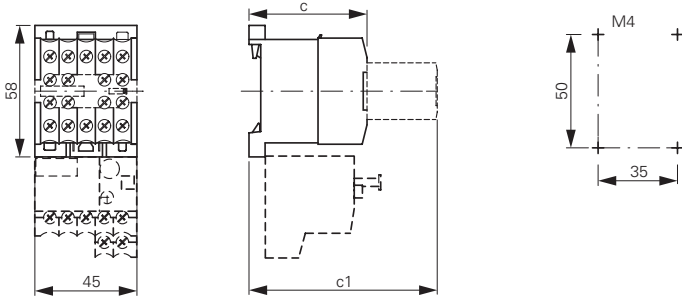

Part no.	c	c1
DILE(E)M...(-G)	52	83
DILE(E)M...-G(-C)	54	86

DILER... + HDILE
DILER...-G + HDILE

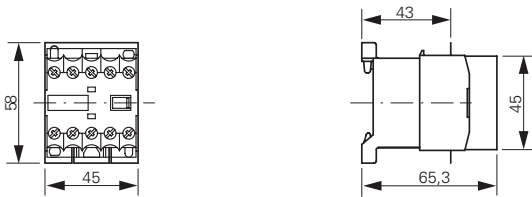

Suppressor circuit

RCDILE...
VGDILE

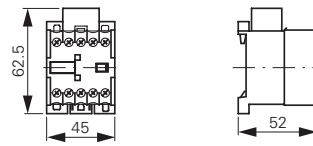

2DILE... + MVDILE
2DILE...-G + MVDILE

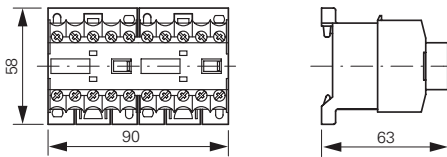

2DILE... + MVDILE + ...DILE
2DILE...-G + MVDILE + ...DILE

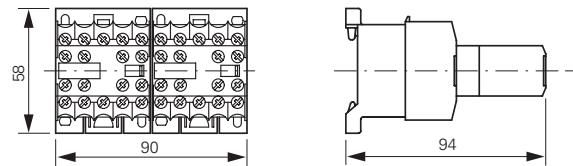

Star-delta contactors

DIULEM

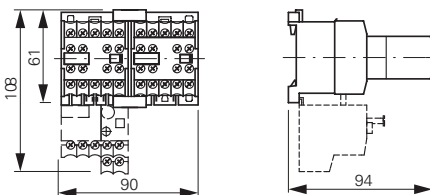

Star-delta contactors

SDAINLEM

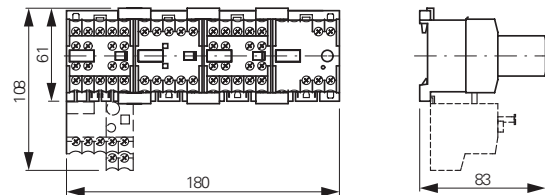

DILER... + TDDILE24

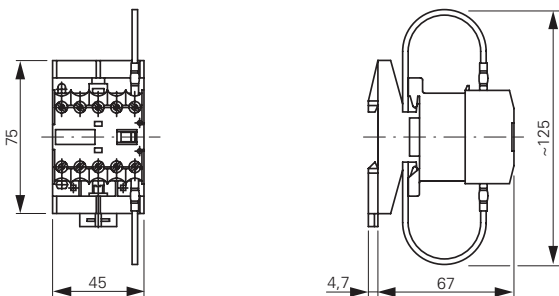

Parallel connector

P1DILEM

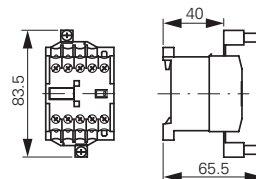

Contactor with auxiliary contact module

DILM7...DILM15

DILA...

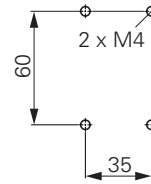
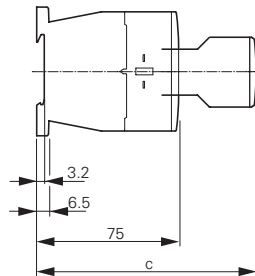
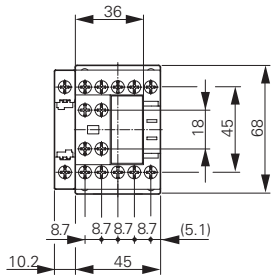

Part no.	c
DILM32-XHI	117
DILA-XHI	117
DILA-XHI...T	125

DILMC7...DILMC15

DILAC...

DILA-XHIC...

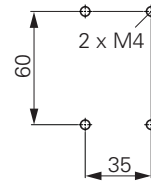
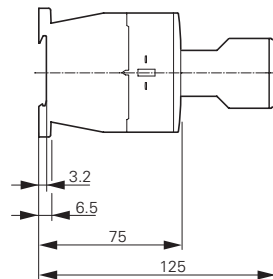
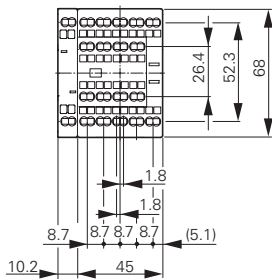

DILM17...DILM38

DILMC17...DILMC32

DILMF8...DILMF32

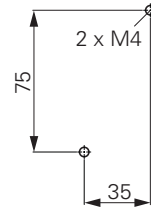
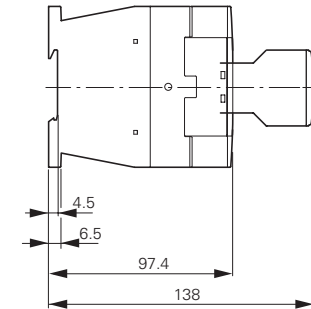
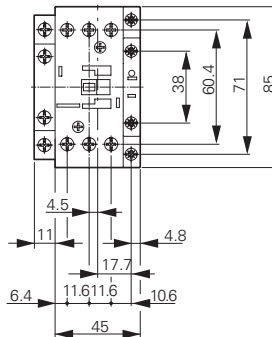

Clearance at side to grounded parts: 6 mm

1.2

Contactors

Basic devices up to 170 A, suppressor circuit

1 Contactors

DILM40...DILM72
DILMC40...DILMC65
DILMF40...DILMF65

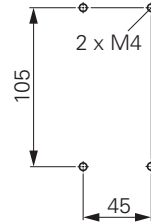
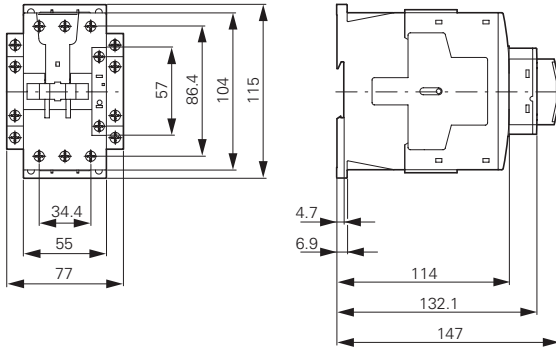

Clearance at side to grounded parts: 6 mm

DILM80...DILM170
DILMC80...DILMC150
DILMF80...DILMF150

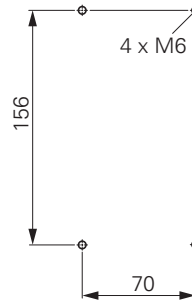
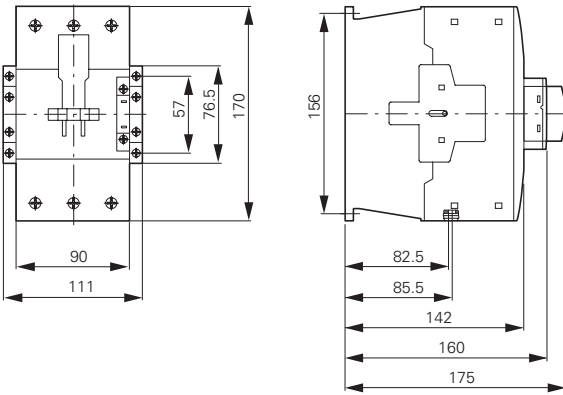

Clearance at side to grounded parts: 10 mm

Suppressor circuits

DILM...XSP...

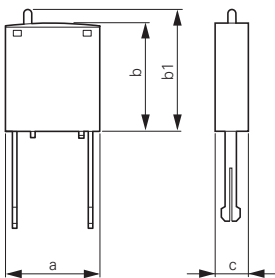

Part no.	a	b	b1	c
DILM12-XSP...	25	28	≈32	9
DILM32-XSP...	25	28	≈32	9
DILM95-XSP...	25	28	≈32	9

Contactor with auxiliary contact module

DILMP20

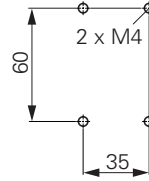
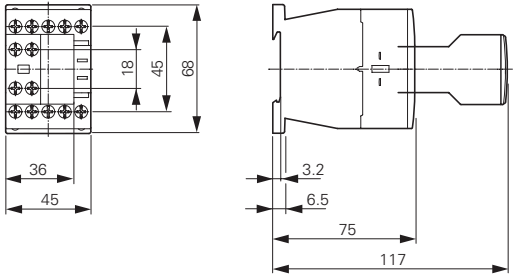

DILMP32 DILMP45

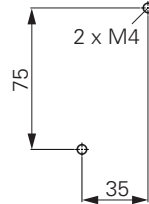
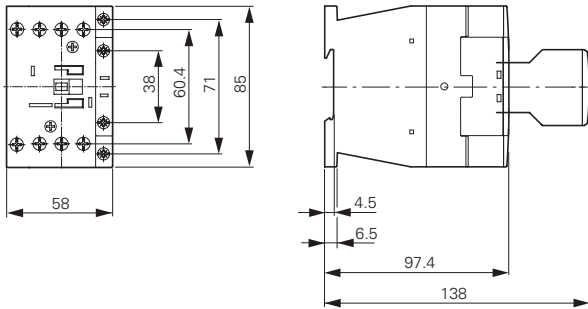

Distance at side to grounded parts: 6 mm

Contactors

DILMP63 DILMP80

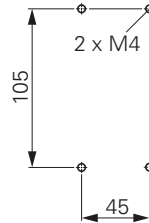
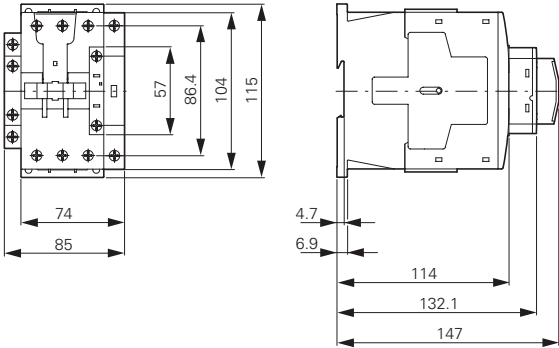

Distance at side to grounded parts: 6 mm

DILMP125 DILMP160 DILMP200

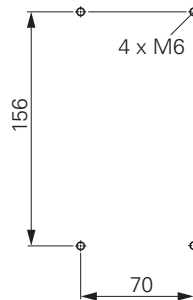
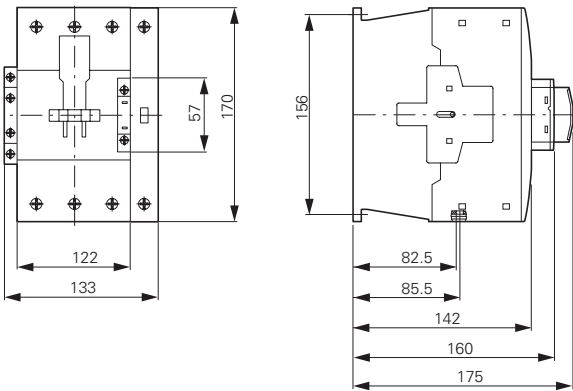

Clearance at side to earthed parts: 10 mm

Motor suppressor module

DILM12-XMSM

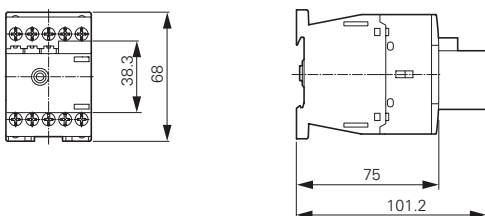

1.2

Contactors

Complete units for currents greater than 170 A

1 Complete units

DILM185A...DILM500
DILM250-S...DILM570-S

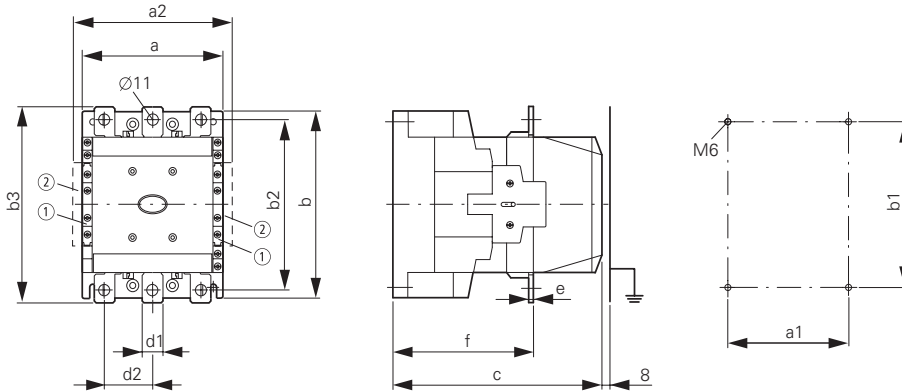

- ① DILM1000-XHI...-SI
- ② DILM1000-XHI11-SA

Part no.	a	a1	a2	b	b1	b2	b3	d1	d2	e	c	f
DILM185A	140	120	160	180	160	165	190	20	41	5	158	83
DILM225A	140	120	160	180	160	165	190	20	41	5	158	83
DILM250	140	120	160	180	160	164	189	25	48	5	208	140
DILM300A	140	120	160	180	160	164	189	25	48	5	208	140
DILM400	160	130	180	200	180	184	209	25	48	6	216	140
DILM500	160	130	180	200	180	189	219	38	57	6	216	140
DILM570	160	130	180	200	180	189	219	38	57	6	216	140

DILM580...DILM1000

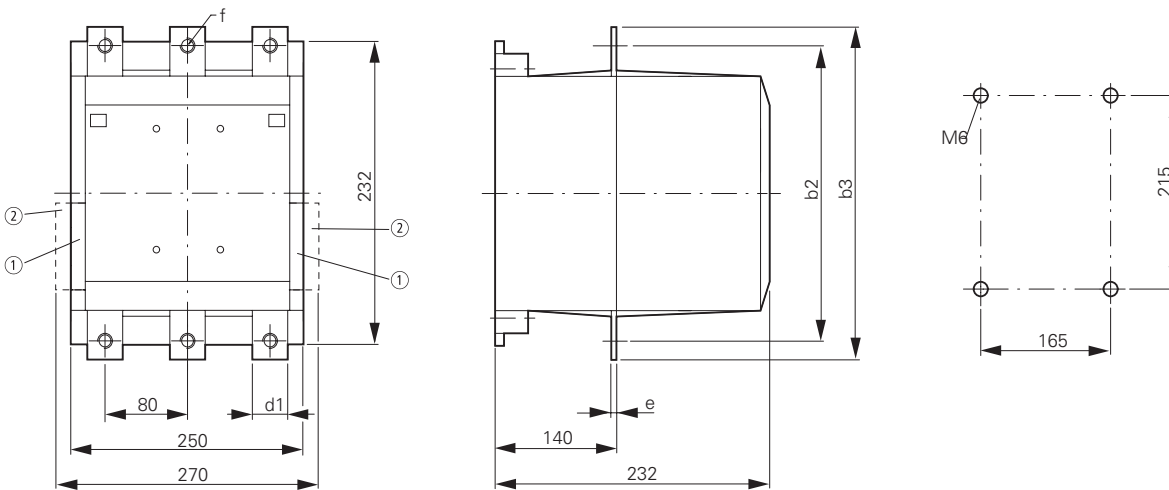

- ① DILM820-XHI...-SI
- ② DILM820-XHI11-SA

Part no.	b2	b3	d1	e	f
DILM580	256	296	45	6	13.5
DILM650	256	296	45	6	13.5
DILM750	256	296	45	6	13.5
DILM820	256	296	45	6	13.5
DILM1000	256	296	45	10	13.5

AC-1 contactors greater than 1000 A

DILH1400

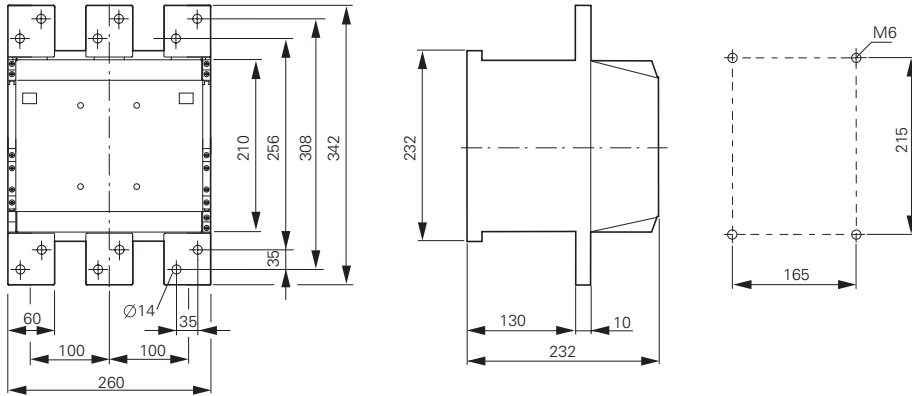

DILM1600

DILH2000

DILH2200

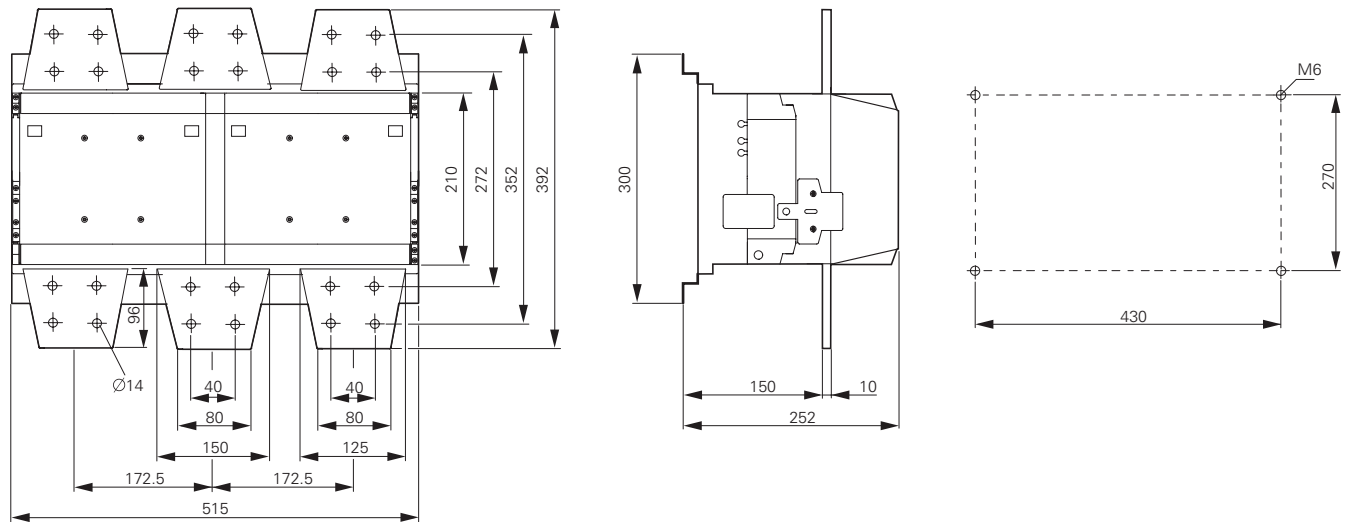

DILH2600

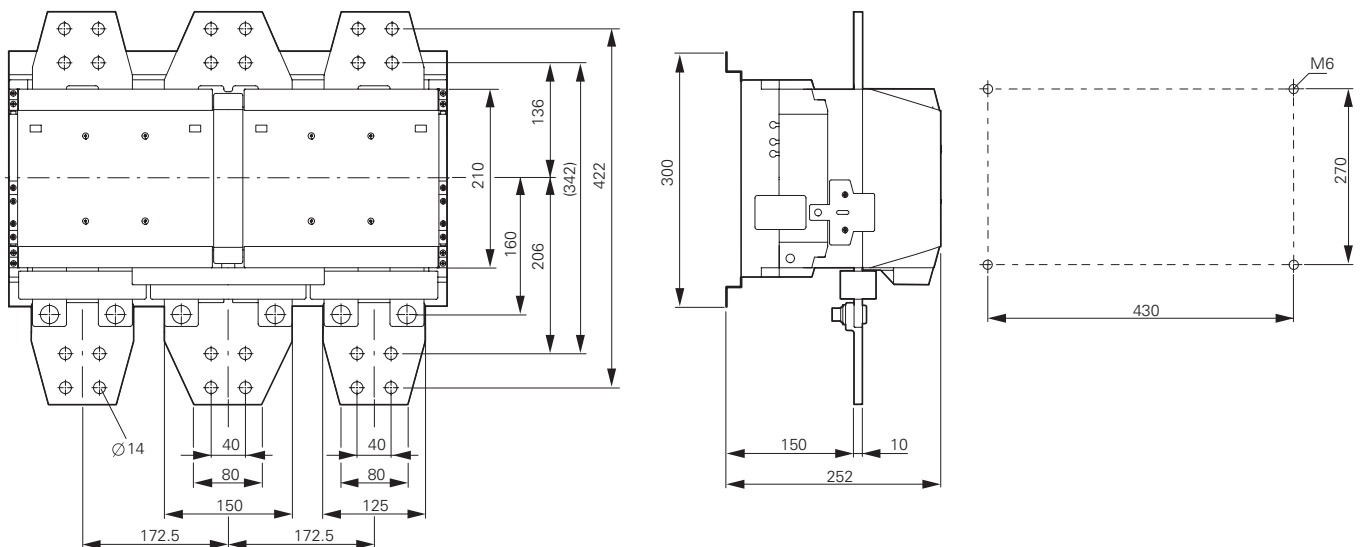

1.2

Contactors

Capacitor contactors, lamp contactors, contactor monitoring devices, SWD contactor modules

1 Contactor for capacitors

DILK...

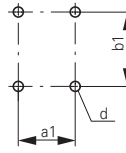
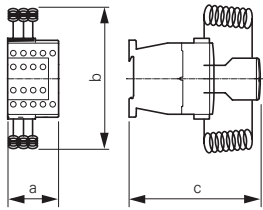

Part no.	a	b	c	a1	b1	d
DILK12	45	135	138	35	75	2 x M4
DILK20	45	135	138	35	75	2 x M4
DILK25	45	135	138	35	75	2 x M4
DILK33	55	190	147	45	105	2 x M4
DILK50	55	190	147	45	105	2 x M4

Illumination contactors

DILL...

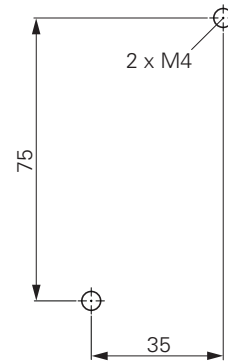
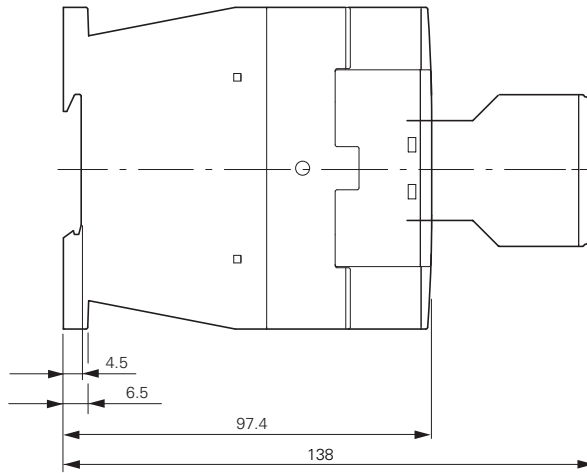
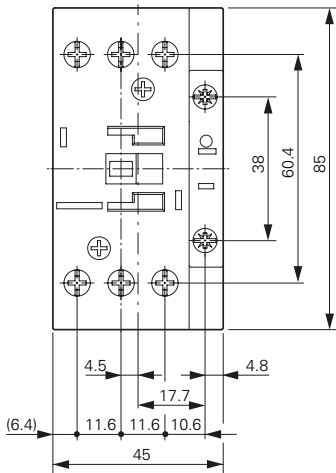

Clearance at side to grounded parts: 6 mm

Contactor monitoring devices

CMD(...)

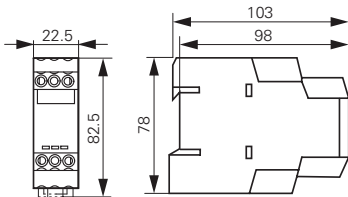

SWD contactor modules

DIL-SWD-32...

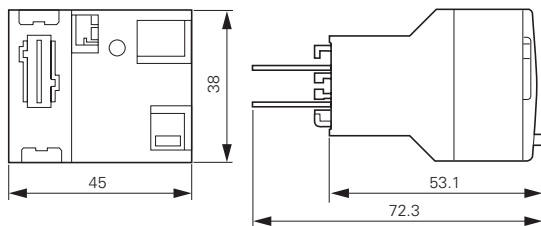

Star-delta contactors

SDAINLM12...SDAINLM115

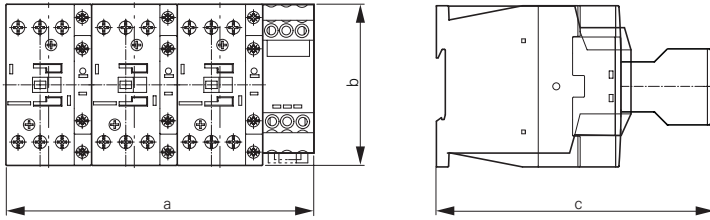

Part no.	a	b	c
SDAINLM12...22	158	68	117
SDAINLM30...55	158	85	138
SDAINLM70...115	188	115	147

SDAINLM140...SDAINLM260

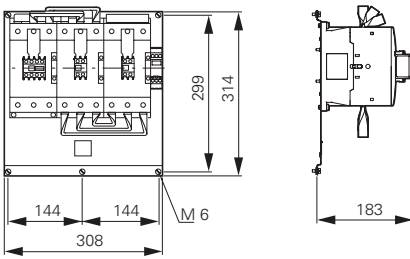

Reversing contactors

DIULM7...DIULM65

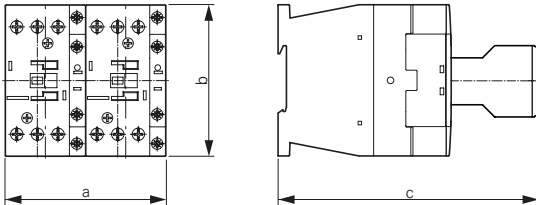

Part no.	a	b	c
DIULM7/21...12/21	90	68	117
DIULM17/21...32/21	90	85	138
DIULM40/11...65/11	110	115	147

DIULM80...DIULM150

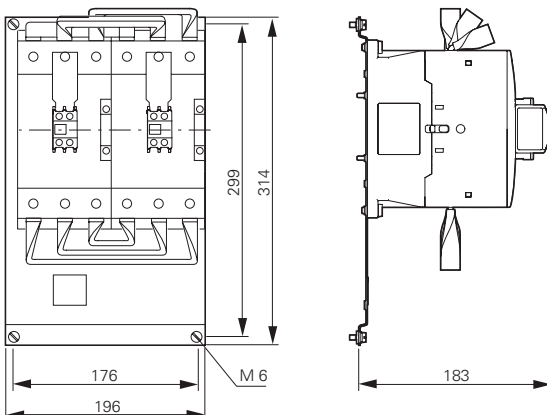

1.2 Contactors

Accessories

1 Three-phase commoning links

DILM12-XDSB...

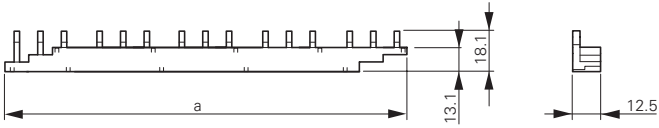

Part no.	a
DILM12-XDSB0/3	112
DILM12-XDSB0/4	157
DILM12-XDSB0/5	202

Electronic timer modules

DILM...XTE

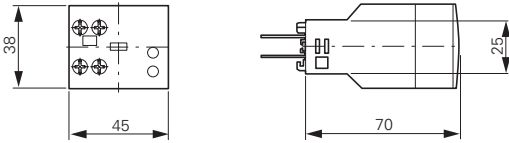

Amplifier module

ETS4-VS3

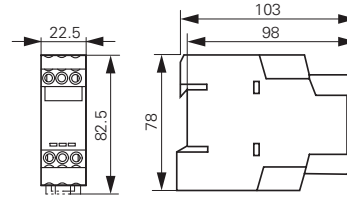

Wiring set for motor feeder plug

DILM12-XMCE

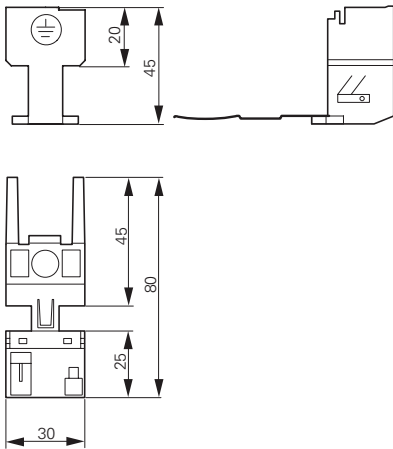

DILM12-XMCP/T

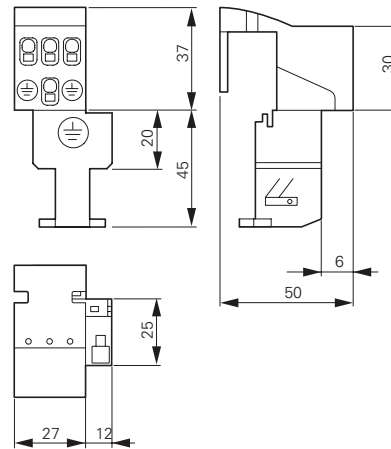

DILM12-XMCP/E

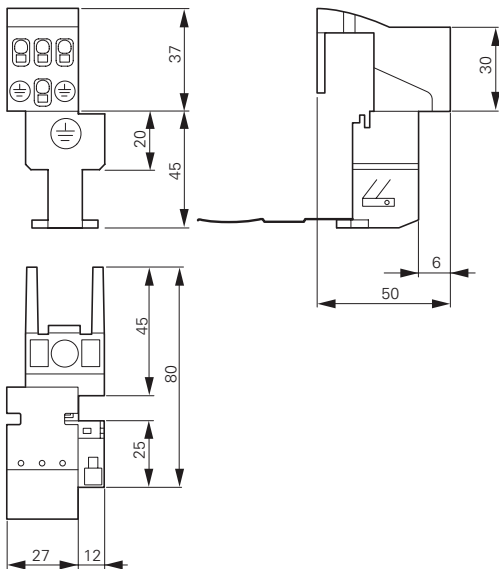

Contactors with terminal shrouds

DILM250...DILM1000 + DILM...-XHB

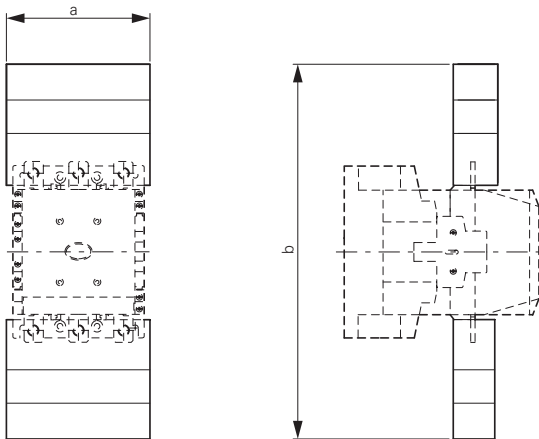

for part no.	a	b
DILM250, DILM300A	150	384
DILM400	150	404
DILM500	174	426
DILM580...1000	236	506

DILM250 + Z5-.../FF250

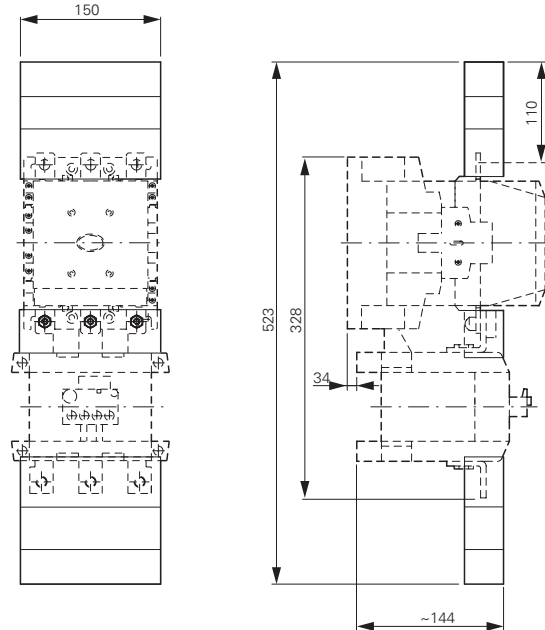

DILM185A...DILM225A + DILM225A-XHB

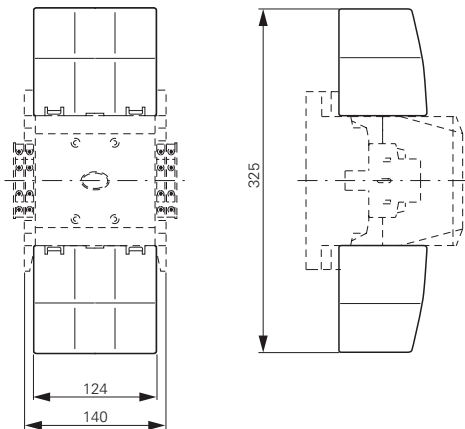

Contactor with star-point bridge and terminal shroud

DILM...XS1

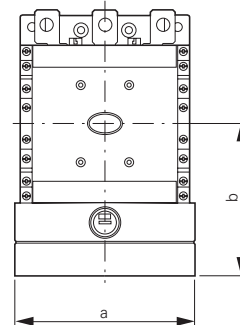

for part no.	a	b
DILM185...250	150	127
DILM300...400	150	137
DILM500	176	146

Mechanical interlock

DILM500-XMV

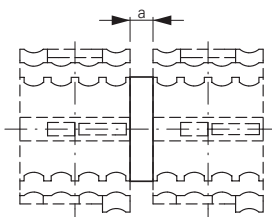

for part no.	a
DILM185...500	15

DILM820-XMV

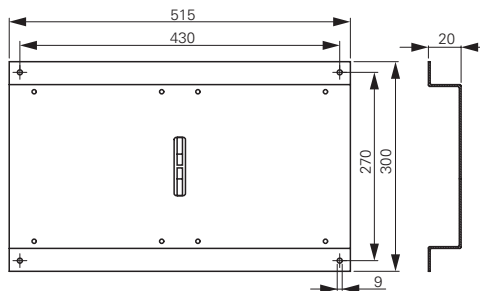

Contactor relays DILA..C



- Varied 4-pole contact configurations
- Conventional thermal current (I_{th}): 16A
- Identical construction sizes for AC- and DC-operated contactor relays
- Integrated surge suppressors for DC-operated contactor relays

Contents

<i>Description</i>	<i>Page</i>
Contactor relays DILA..C	
System overview	3
Basic devices DILA..C	5
Auxiliary contact modules	7
Accessories	9
Actuating voltages	11
Characteristic curves, contact travel diagrams	12
Technical data	13
Dimensions	19

1.3

Contactor relays DILA..C

System overview

1

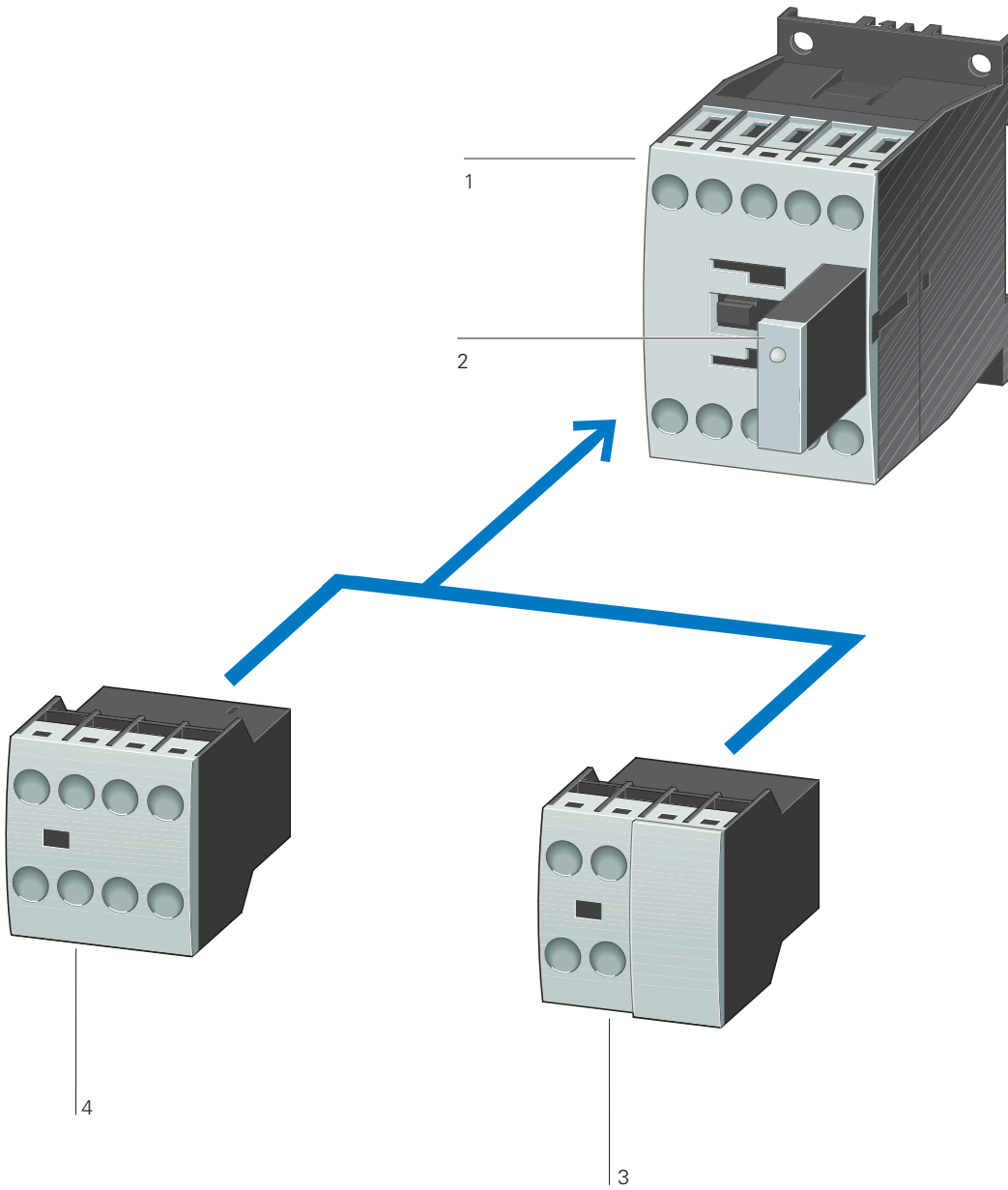

System overview

Basic devices	1
AC or DC operated	
Magnet system	
AC 24 – 400V, 50, 60, 50/60 Hz	
0.8 – 1.1 × U _c	
24 VA/3.4 VA	
DC 24 – 220 V DC	
0.8 – 1.1 × U _c	
At 24 V:	
0.7 – 1.3 × U _c without auxiliary contact modules	
Ambient temperature +40°C	
3W/3W	
Up to 8 sets of normally open or normally closed contacts	
Interlocked opposing contacts	
Modular system	
Screw connection and plug-in connection	
Finger-proof protection	
Screw terminals	
From page 5	
Suppressor circuits	2
DC operated contactors (all DC operated contactors have an integrated suppressor)	
AC operated contactors	
From page 32	
Auxiliary contact modules	3, 4
2 or 4 poles	
Interlocked opposing contacts	
From page 7	

1.3

Contactor relays DILA..C

Basic devices

1 Screw terminals

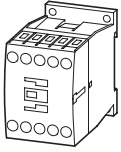

Basic devices with interlocked opposing contacts

Contact		Rated operational current		Conventional thermal current at 60 °C	Distinctive number	Circuit symbol
		AC – 15				
N/O = Normally opened contact		220 V	380 V			
N/C = Normally closed contact		230 V	400 V			
		240 V	415 V			
		I_e	I_e	I_{th}		
		A	A	A		
4 N/O	–	4	4	16	40E	
3 N/O	1 N/C	4	4	16	31E	
2 N/O	2 N/C	4	4	16	22E	

Auxiliary contact module to use with	AC operation Part no. Article no.	DC operation Part no. Article no.	Std. pack	Notes
	Operating voltage 220-230V50Hz	Operating voltage 24VDC		
DILAC-XHI(V)...	DILA-40C(220-230V50Hz) 114842	DILA-40C(24VDC) 114847	1 Off	With screw terminals
DILAC-XHI(V)...	DILA-31C(220-230V50Hz) 114852	DILA-31C(24VDC) 114857	1 Off	
DILAC-XHI(V)...	DILA-22C(220-230V50Hz) 114862	DILA-22C(24VDC) 114867	1 Off	

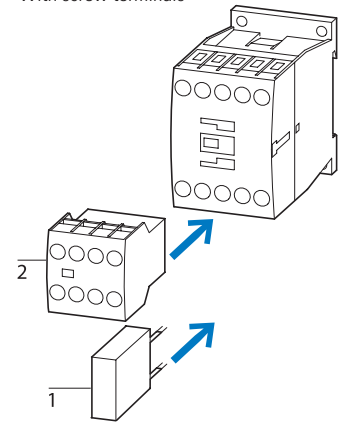

Accessories	Page
1 Suppressor	→ 32
2 Auxiliary contact module	→ 7
Operating voltage	→ 11

Contact numbers to EN 50011
Coil terminal marking as specified in EN 50005

DC operated contactor relays have an integrated suppressor

1.3

Contactor relays DILA..C

Auxiliary contact modules

1

DILA..C auxiliary contact modules

With interlocked opposing contacts (except ...XHI(C)V)

Contact	Rated operational current		Conventional thermal current at 60 °C	Circuit symbol	
	220 V	380 V			
N/O = Normally open contact N/O _E = N/O, early-make N/C = Normally closed contact N/C _L = N/C, late-break	AC – 15				
	230 V	400 V			
	240 V	415 V			
	I _e	I _e	I _{th}		
	A	A	A		
–	2 N/C	4	4	16	
1 N/O	1 N/C	4	4	16	
2 N/O	–	4	4	16	
1 N/O _E	1 N/C _L	4	4	16	
–	4 N/C	4	4	16	
1 N/O	3 N/C	4	4	16	
2 N/O	2 N/C	4	4	16	
3 N/O	1 N/C	4	4	16	
4 N/O	–	4	4	16	
1 N/O, 1 N/O _E	1 N/C, 1 N/C _L	4	4	16	

2 pole Screw terminals



4 pole Screw terminals



Can be combined with contactor			Part no. Article no.	Std. pack	Notes
DILA-40C	DILA-31C	DILA-22C			
42E	33	24	DILAC-XHI02 (Auxiliary) 114872	5 Off	Type E combinations comply with EN 50011 and are to be given preference. Other types comply with EN 50005 DC operated contactor DILA-22C must be combined with 2 pole auxiliary contacts.
51E	42	33	DILAC-XHI11 114871	5 Off	
60E	51	42	DILAC-XHI20 114870	5 Off	
51	42	33	DILAC-XHIV11 276423	5 Off	
44E	35	26	DILAC-XHI04 114877	5 Off	
53E	44	35	DILAC-XHI13 114876	5 Off	
62E	53	44	DILAC-XHI22 114875	5 Off	
71E	62	53	DILAC-XHI31 114874	5 Off	
80E	71	62	DILAC-XHI40 114873	5 Off	
62	53	44	DILA-XHIV22 276429	5 Off	

Accessories

Electronic timer modules

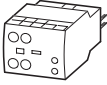

Operating voltage	For use with	Circuit Symbol	Part no. Article no.	Std. pack	Notes	
On-delayed						
24 V AC/DC	DILM7..C - DILM32..C		DILM32-XTEE11(RA24) 101440	1 Off	Time range 0.05 s...1 s Cannot be combined with • DILAC-XHI... • DILM32C-XHI... • DILM12-XSP... • DILM32-XSP...	
100...130 V AC	DILMP20C DILA..C		DILM32-XTEE11(RAC130) 101441	1 Off		Time range 0.5 s...10 s
200...240 V AC			DILM32-XTEE11(RAC240) 101442	1 Off		Time range 5 s...100 s
Off-delayed						
24 V AC/DC	DILM7..C - DILM32..C		DILM32-XTED11-1(RA24) 105210	1 Off	Time range 0.05 s...1 s Cannot be combined with • DILAC-XHI... • DILM32C-XHI... • DILM12-XSP... • DILM32-XSP...	
24 V AC/DC	DILMP20C DILA..C		DILM32-XTED11-10(RA24) 104943	1 Off		Time range 0.5 s...10 s
24 V AC/DC			DILM32-XTED11-100(RA24) 104946	1 Off		Time range 5 s...100 s
100...130 V AC			DILM32-XTED11-1(RAC130) 105211	1 Off		Time range 0.05 s...1 s
100...130 V AC			DILM32-XTED11-10(RAC130) 104944	1 Off		Time range 0.5 s...10 s
100...130 V AC			DILM32-XTED11-100(RAC130) 104947	1 Off		Time range 5 s...100 s
200...240 V AC			DILM32-XTED11-1(RAC240) 105212	1 Off		Time range 0.05 s...1 s
200...240 V AC			DILM32-XTED11-10(RAC240) 104945	1 Off		Time range 0.5 s...10 s
200...240 V AC			DILM32-XTED11-100(RAC240) 104948	1 Off		Time range 5 s...100 s
For star-delta applications						
24 V AC/DC	DILM7..C - DILM32..C		DILM32-XTEY20(RA24) 101446	1 Off	Changeover time: 1 s...30 s Cannot be combined with • DILAC-XHI... • DILM32C-XHI... • DILM12-XSP... • DILM32-XSP...	
100...130 V AC	DILMP20C DILA..C		DILM32-XTEY20(RAC130) 101447	1 Off		Changeover delay: 50 ms
200...240 V AC			DILM32-XTEY20(RAC240) 101448	1 Off		
-	DILM32-XTE...	-	DILM32-XTEPLH 101449	1 Off	-	
Sealable shrouds Transparent						
Contact connectors						
-	DILM7..C - DILM..72C DILA..C	-	DILM32-XVB 281227	50 Off	For mechanically linking contactors in combinations 0 mm distance between contactors.	
Mechanical interlocks incl. contactor connector.						
-	DILM7..C - DILM..15C DILMP20C DILA..C	-	DILM12-XMV 281196	1 Off	For two contactors with AC or DC operation arranged vertically or horizontally. Distance between contactors 0 mm. Mechanical lifespan 2.5 × 10 ⁶ operations.	

Input with integrated suppressor circuit for overvoltage limitation

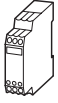

Amplifier module for separate mounting²⁾

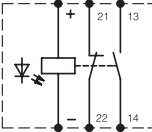
Rated operational current			Actuating voltage	Actuating current	Circuit symbol	For use with	Part no. Article no.	Std. pack
AC – 15	DC ¹⁾		U_c	I				
240 V	415 V	220 V	VDC	mA				
I_e	I_e	I_e						
A	A	A						
2	2	0.03	24	25		Any	ETS4-VS3 083094	1 Off

Notes
 1) Making and breaking conditions DC-13, time L/R 300ms
 2) Contactor coils with rated operational current > 2A must be actuated via the DILA contactor relay.

Self-adhesive label sheet

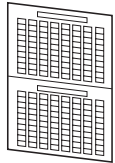

Label sheet

For use with	Part no. Article no.	Std. pack	Notes
Labelling with laser printer, plotter, film plotter, copier	XGKE-GE 207517	25 Off	1 off = 1 sheet 240 labels per sheet 1 sheet = DIN A4 Can be split into two DIN A5

1.3

Contactor relays DILA..C

Actuating voltages

1 AC

	DILA-40C(...) Article no. ¹⁾	DILA-31C(...) Article no. ¹⁾	DILA-22C(...) Article no. ¹⁾
Standard voltage			
24V 50Hz	114840	114850	114860
110V 50Hz	114841	114851	114861
220V-230V 50Hz	114842	114852	114862
380-400V 50Hz	114843	114853	114863
24V 50/60Hz	114844	114854	114864
110V 50/60Hz	114845	114855	114865
220V 50/60Hz	114846	114856	114866

DC

	DILA-40C(...) Article no. ¹⁾	DILA-31C(...) Article no. ¹⁾	DILA-22C(...) Article no. ¹⁾
Standard voltage			
24V DC	114847	114857	114867
110V DC	114848	114858	114868
220V DC	114849	114859	114869

Notes 1) The article number is a combination of part no. and operating voltage.

Characteristic curves

DILA..C(AC-15)

Component lifespan (operations)
 I_e = Rated operational current

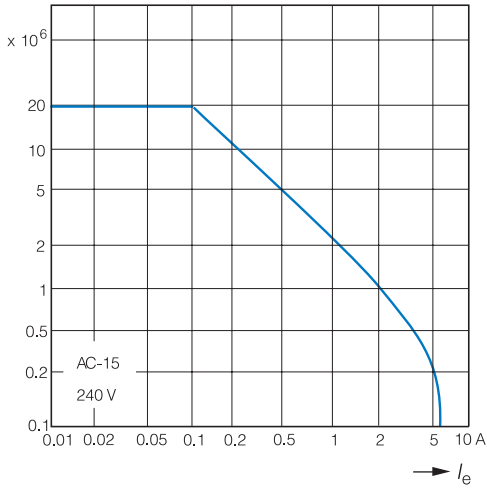

DILA..C(DC-13¹⁾)

Component lifespan (operations)
 I_e = Rated operational current

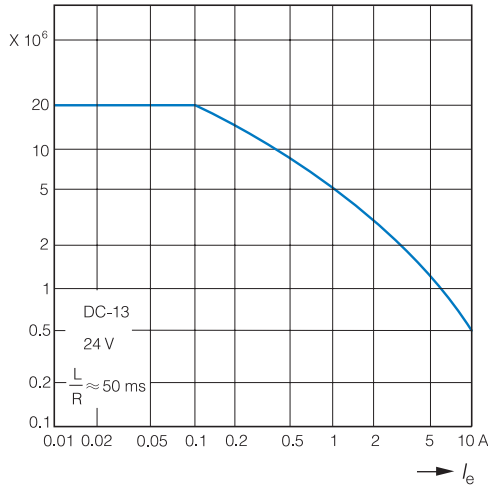

Contact travel diagrams

The diagrams show the closing and opening travel of the contacts at no load.

DILAC...AC



DILAC...DC



DILAC-XHI(C)...AC



DILAC-XHI(C)...DC



DILAC-XHI(C)V...AC

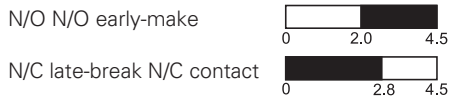

DILAC-XHI(C)V...DC

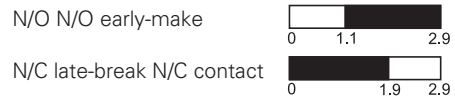

Notes 1) Switch-on and switch-off conditions based on DC-13, time constant as specified

1.3

Contactor relays DILA..C

Technical data

1 Technical data

		DILA..C		DILAC..XHI	
General					
Standard		IEC/EN 60947, VDE 0660, GB 14048			
Lifespan, mechanical					
AC operated	Operations	$\times 10^6$	20		10
DC operated	Operations	$\times 10^6$	20		10
Maximum operating frequency					
Maximum operating frequency	Operations/h		9000		9000
Climatic proofing					
Damp heat, constant, to IEC 60068-2-78					
Damp heat, cyclic, to IEC 60068-2-30					
Ambient temperature					
Open		°C	-25...60		-25...60
Enclosed		°C	-25...40		-25...40
For storage		°C	-40...80		-40...80
Mounting position					
Mounting position					
Mechanical shock resistance (IEC/EN 60068-2-27)					
Half-sinusoidal shock 10 ms					
Basic devices with auxiliary contact module					
N/O		g	7		7
N/C		g	5		5
Protection type					
IP20					
Protection against direct contact when actuated from front (EN 50274)					
Finger- and back-of-hand proof					
Weight					
AC operated		kg	0.23		0.05
DC operated		kg	0.28		0.05
Terminal capacity					
Screw terminals					
Solid		mm ²	1 × (0.75 – 4) 2 × (0.75 – 2.5)		1 × (0.75 – 4) 2 × (0.75 – 2.5)
Flexible with ferrule		mm ²	1 × (0.75 – 2.5) 2 × (0.75 – 2.5)		1 × (0.75 – 2.5) 2 × (0.75 – 2.5)
Solid or stranded		AWG	18 – 14		18 – 14
Terminal screw					
M3.5					
Pozidriv screwdriver					
Size 2					
Flat-blade screwdriver					
mm 0.8 × 5.5 1 × 6 1 × 6					
Max. tightening torque					
Nm 1.2 1.2					
Spring-loaded terminals					
Solid		mm ²	1 × (0.75 – 2.5) 2 × (0.75 – 2.5)		1 × (0.75 – 2.5) 2 × (0.75 – 2.5)
Flexible with/without ferrule DIN 46228		mm ²	1 × (0.75 – 1.5) 2 × (0.75 – 1.5)		1 × (0.75 – 1.5) 2 × (0.75 – 1.5)
Solid or stranded		AWG	18 – 14		18 – 14
Flat-blade screwdriver					
mm 0.6 × 3.5 0.6 × 3.5					

Technical data

		DILA..C		DILAC..XHI	
Contacts					
Interlocked opposing contacts to EN 60947-4-1, Annex L, including auxiliary contact module			Yes		Yes
Rated impulse withstand voltage	U_{imp}	V AC	6000		6000
Over-voltage category/degree of pollution			III/3		III/3
Rated insulation voltage	U_i	V AC	690		690
Rated operating voltage	U_e	V AC	690		500
Safe isolation according to EN 61140					
Between coil and auxiliary contacts		V AC	400		400
Between the auxiliary contacts		V AC	400		400
Rated operational current					
AC-15					
220/240 V	I_e	A	4		4
380/415 V	I_e	A	4		4
500 V	I_e	A	1.5		1.5
DC-13 ¹⁾					
DC-13 L/R ≤ 15 ms					
Contacts in series:					
1	24 V	A	10		10
1	60 V	A	6		6
2	60 V	A	10		10
1	110 V	A	3		3
3	110 V	A	6		6
1	220 V	A	1		1
3	220 V	A	5		5
DC-13 L/R ≤ 50 ms					
Contacts in series:					
3	24 V	A	4		–
3	60 V	A	4		–
3	110 V	A	2		–
3	220 V	A	1		–
Control circuit reliability (at $U_e = 24$ V DC, $U_{min} = 17$ V, $I_{min} = 5.4$ mA)		Fault probability	λ	< one failure in 100 million operations	
Conventional thermal current		I_{th}	A	16	16
Short-circuit strength without welding					
Maximum over-current protection device					
220/240 V		PKZMO	4		–
380/415 V		PKZMO	4		–
Short-circuit protection rating maximum fuse ²⁾					
500 V		A gG/gL	10		10
Current heat loss at load of I_{th}					
AC operated		W	0.3		0.3
DC operated		W	0.3		0.3

- Notes** 1) Switch-on and switch-off conditions based on DC-13, time constant as specified
2) See characteristic curve "Fuses" for time/current characteristics (please enquire)

1.3

Contactor relays DILA..C

Technical data

1 Technical data

		DILA..C		DILAC..XHI
Magnet system				
Voltage tolerance				
AC operated	Pick-up	$\times U_c$	0.8 – 1.1	–
DC operated ¹⁾	Pick-up	$\times U_c$	0.8 – 1.1	–
	Pick-up	$\times U_c$	0.7 – 1.3	–
Power consumption without auxiliary contact module (40 °C)				
50 Hz	Pick-up	VA	24	–
50 Hz	Sealing	VA	3.4	–
50 Hz	Sealing	W	1.2	–
60 Hz	Pick-up	VA	30	–
60 Hz	Sealing	VA	4.4	–
60 Hz	Sealing	W	1.4	–
50/60 Hz	Pick-up	VA	27	–
			25	
50/60 Hz	Sealing	VA	4.2	–
			3.3	
50/60 Hz	Sealing	W	1.4	–
			1.2	
DC operated ¹⁾	Pick-up=Sealing	W	3	–
Duty factor		% DF	100	–
Changeover times at 100 % U_c (recommended values)				
Main contact				
AC operated				
	closing delay	ms	15 – 21	–
	opening delay	ms	9 – 18	–
DC operated				
	closing delay	ms	31	–
	opening delay	ms	12	–

Notes 1) Smoothed DC, three-phase bridge rectifier or smoothed two-phase bridge rectifier

Amplifier modules, electronic timer module

1

			ETS4-VS3	DILM32-XTE
General				
Standard			IEC/EN 60947, VDE 0660, UL, CSA	DIN EN 61812, IEC/EN 60947, VDE 0660, UL, CSA
Lifespan, mechanical				
AC operated	Operations	$\times 10^6$	–	3
DC operated	Operations	$\times 10^6$	30	3
Maximum operating frequency				
220 V 230 V	Operations	$\times 10^6$	72000	–
Climatic proofing				
			Damp heat, constant, to IEC 60068-2-78; Damp heat, cyclic, to IEC 60068-2-30	
Ambient temperature				
For storage		°C	–	-40...80
Open		°C	-25...60	-25...60
Enclosed		°C	-25...45	-25...40
Mounting position			Any	As required, except suspended
Mechanical shock resistance (IEC/EN 60068-2-27)				
Half-sinusoidal shock 20 ms				
	N/O	g	10	–
Half-sinusoidal shock 10 ms				
	N/O	g	10	6
	N/C	g	8	6
Protection type			IP20	IP20
Protection against direct contact when actuated from front (EN 50274)			Finger- and back-of-hand proof	
Weight		kg	0.09	0.08
Terminal capacity				
Solid		mm ²	1 × (0.75 – 2.5) 2 × (0.75 – 2.5) ¹⁾	1 × (0.75 – 2.5) 2 × (0.75 – 1.5)
Flexible with ferrule		mm ²	1 × (0.75 – 2.5) 2 × (0.75 – 1.5) ¹⁾	1 × (0.75 – 1.5) 2 × (0.75 – 1.5)
Solid or stranded		AWG	16 – 14	18 – 14
Screw terminals			M3.5	M3.5
Pozidriv screwdriver		Size	2	2
Flat-blade screwdriver		mm	0.8 × 5.5 1 × 6	0.8 × 5.5 1 × 6
Max. tightening torque		Nm	1.2	1.2

Notes 1) Use equal cross-sections only

1.3

Contactor relays DILA..C

Amplifier modules, electronic timer module

1 Amplifier modules, electronic timer module

		ETS4-VS3		DILM32-XTE	
Contacts					
Rated impulse withstand voltage	U_{imp}	V AC	6000		6000
Over-voltage category/degree of pollution			III/2		III/3
Rated insulation voltage	U_i	V AC	440		600
Rated operating voltage	U_e	V AC	440		400
Rated operational current					
AC-15					
220/240 V	I_e	A	2		Please enquire
380/415 V	I_e	A	2		Please enquire
DC-13 ¹⁾					
DC-13 L/R ≤ 15 ms					
Contacts in series:					
1	24 V	A	2.6		–
1	60 V	A	1		–
1	110 V	A	0.6		–
1	220 V	A	0.2		–
DC-13 L/R ≤ 50 ms					
Contacts in series:					
1	24 V	A	2		–
1	60 V	A	0.6		–
1	110 V	A	0.08		–
1	220 V	A	0.08		–
DC-13 L/R ≤ 300 ms					
Contacts in series:					
1	24 V	A	0.6		–
1	60 V	A	0.2		–
1	110 V	A	0.08		–
1	220 V	A	0.03		–
Safe isolation according to EN 61140					
Between coil and auxiliary contacts		V AC	–		250
Between the auxiliary contacts		V AC	–		250
Control circuit reliability (at $U_e = 24$ V DC, $U_{min} = 17$ V, $I_{min} = 5.4$ mA)		Fault probability	λ	< one failure in 100 million operations	
Conventional thermal current		I_{th}	A	6	6
Lifespan, mechanical					
AC-15					
230 V, $I_e = 0.1$ A	Operations	$\times 10^6$	7		–
230 V, $I_e = 1.2$ A	Operations	$\times 10^6$	1		–
Short-circuit strength without welding					
Maximum over-current protection device ²⁾					
500 V		A gG/gL	–		6
500 V		A fast	4		–

Notes 1) Switch-on and switch-off conditions based on DC-13, time constant as specified
2) See transparent overlay "Fuses" for time/current characteristics (please enquire)

Amplifier modules, electronic timer module

1

	ETS4-VS3			DILM32-XTE
Magnet system				
Voltage tolerance				
Voltage tolerance				
AC operated	Pick-up	$\times U_c$	–	0.85 – 1.1
AC operated	Pick-up	$\times U_c$	0.85 – 1.2	0.7 – 1.2
Power consumption				
AC	Sealing	VA	–	2
DC ¹⁾	Sealing	W	–	1.8
DC operated ¹⁾	Pick-up=Sealing	W	0.6	–
Duty factor		% DF	100	100
Changeover times at 100 % U_c (recommended values)				
DC operated, closing delay		ms	7	–
DC operated, opening delay		ms	3	–
Maximum operating frequency				
Maximum operating frequency		Ops/h	–	3600
6 A/250 V		Ops. /h	9000	360
Minimum on duration				
On-delayed		ms	< –	< 50
Off-delayed		ms	< –	< 200
Repetition accuracy (with constant parameters)	Deviation	%	< –	< 5
Recovery time (after 100% time delay)		ms	–	70
Contact changeover time				
DILM32-XTEE11/DILM32-XTED11	t_u	ms	–	10
DILM32-XTEY20	t_u	ms	–	50

Notes: 1) Smoothed DC, three-phase bridge rectifier or smoothed two-phase bridge rectifier

1.3 Contactor relays DILA..C

Dimensions

1 Basic devices with DILAC-...-XHI auxiliary contact modules

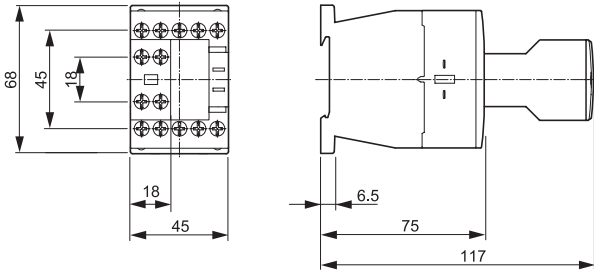

Electronic timer modules

DILM32-XTE

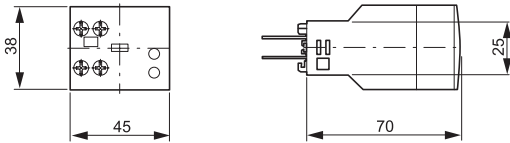

Basic devices with DILM...XMV mechanical interlock

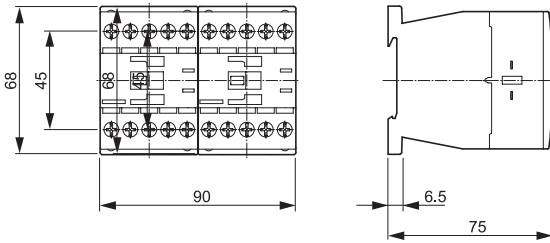

Suppressor circuits

DILM12-XSP...

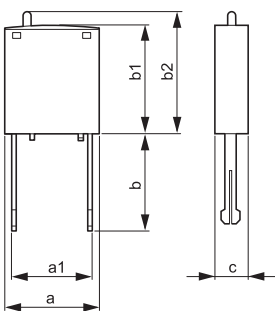

DILM12-XSPR...
DILM12-XSPV...
DILM12-XSPI...

a	25
a1	9.2
b	25.9
b1	28
b2	≈ 32
c	9

Contactor DILM..C



- Easier engineering through identical construction sizes for AC- and DC-operated contactors
- Cost and energy savings for control panel ventilation due to reduced heat dissipation
- Less amount of coupler relays due to direct actuation from the PLC for contactors up to 32A
- Easy engineering through integrated suppressor circuits for DC/AC operated contactors rated 115A, 150A, 170A

Contents

Description	Page
Contactor DILM..C	
Technical overview	23
System overview	25
Basic devices DILM..C	27
Auxiliary contact modules for DILM7..C-DILM38..C	29
Auxiliary contact modules for DILM40..C-DILM170..C	31
Accessories	32
Actuating voltage	36
Contact travel diagrams	39
Characteristic curves	40
Engineering	41
Technical data	43
Dimensions	52

1.3

Contactor DILM..C

Technical overview

1 Contactor DILM..C

3 pole

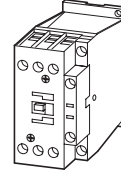
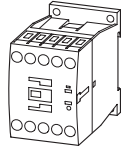

DIL Basic devices	Page	M7..C Page 28	M9..C Page 28	M12..C Page 28	M15..C Page 28	M17..C Page 28	M25..C Page 28	M32..C Page 28
Rated-operational voltage		kW	kW	kW	kW	kW	kW	kW
AC-3								
Rated operational power for 3-phase motors 50 – 60 Hz								
220 V – 230 V		2.2	2.5	3.5	4	5	7.5	10
380 V – 400 V		3	4	5.5	7.5	7.5	11	15
660 V/690 V		3.5	4.5	6.5	7	11	14	17
AC-4								
Rated operational power for 3-phase motors 50 – 60 Hz								
220 V – 230 V		1	1.5	2	2	2.5	3.5	4
380 V – 400 V		2.2	2.5	3	3	4.5	6	7
660 V/690 V		2.9	3.6	4.4	4.4	6.5	8.5	10
AC-1								
Rated operational power under resistive load, 40 °C								
220 V – 230 V		8	8	8	8	15	17	17
380 V – 400 V		14	14	14	14	26	29	29
660 V/690 V		25	25	25	25	45	51	51
Conventional thermal current $I_{th} = I_e$, open at 40 °C								
40°C		22	22	22	22	40	45	45
60°C		20	20	20	20	35	40	40

Contactor DILM..C

4 pole

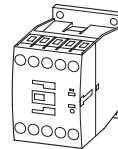

DIL Page	MP20C Page 28
Rated-operational voltage	
AC-1	
Conventional thermal current $I_{th} = I_e$, open at 40 °C	
40°C	22
60°C	20

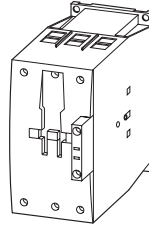
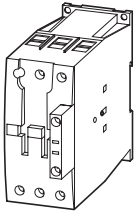

M38..C Page 28	M40C Page 28	M50C Page 28	M65C Page 28	M72C Page 28	M80C Page 28	M95C Page 28	M115C Page 28	M150C Page 28	M170C Page 28
-------------------	-----------------	-----------------	-----------------	-----------------	-----------------	-----------------	------------------	------------------	------------------

kW	kW	kW	kW	kW	kW	kW	kW	kW	kW
----	----	----	----	----	----	----	----	----	----

11	12.5	15.5	20	20	25	30	37	48	52
18.5	18.5	22	30	37	37	45	55	75	90
22	23	30	35	35	63	75	90	96	140

4	5	6	7	7	12	16	17	20	20
7	9	10	12	12	20	26	28	33	33
10	12	14	17	17	26	35	43	48	48

17	22	30	37	37	42	49	61	72	85
29	39	53	65	65	72	85	105	125	150
51	68	91	111	111	125	148	182	216	268

A	A	A	A	A	A	A	A	A	A
45	60	80	98	98	110	130	160	190	203
40	50	65	80	80	90	110	130	160	185

1.3

Contactor DILM.C System overview

1

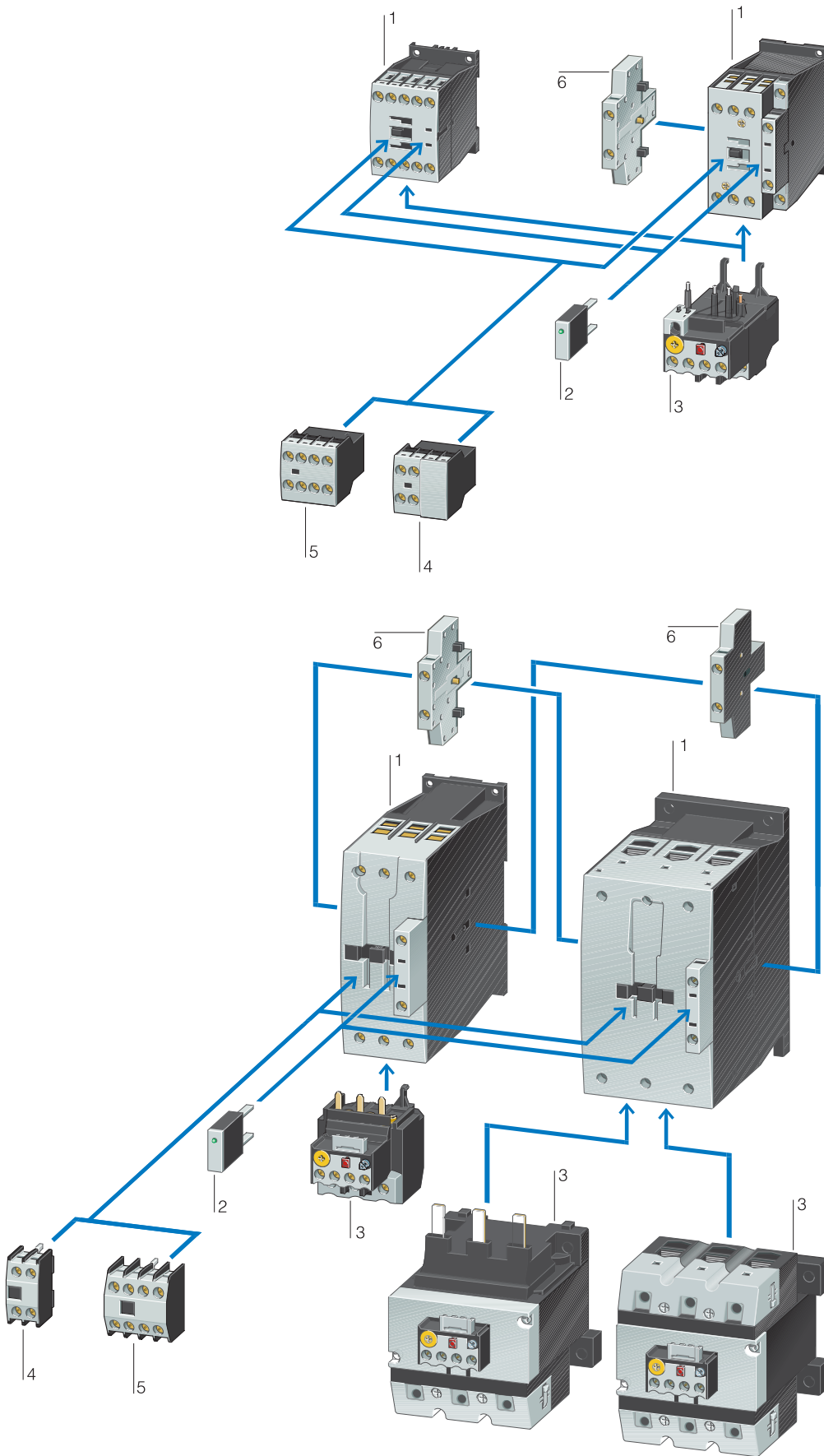

System overview

Contactors up to 90 kW (AC-3/400V)	1
Magnet system	
AC: 24 – 440 V, 50, 60, 50/60 Hz	
0.8 – 1.1 × U _c	
DC: 24 – 240 V	
DILM7..C – DILM15..C: 0.8 – 1.1 × U _c	
DILM17..C – DILM170C: 0.7 – 1.2 × U _c	
at 24 V: 0.7 – 1.3 × U _c	
Without auxiliary contact modules Ambient temperature: +40°C	
→ 27	

Suppressor circuits	2
RC suppressors	
Varistor suppressors	
Diode suppressors	
→ 32	

Overload relays	3
Direct mounting	
Separate mounting	
→ 57	

Auxiliary contact modules	4
2 pole, screw terminals	
→ 29	

Auxiliary contact modules	5
4 pole, screw terminals	
→ 29	

Auxiliary contact modules	6
2 pole, side mounting	
→ 29	

Auxiliary contact module to use with

AC operation Part no. Article no.	DC operation Part no. Article no.	Std. pack
---	---	-----------

Notes

	Operating voltage 220-230V50Hz	Operating voltage 24VDC	
DILM32C-XHI.. DILAC-XHI..	DILMP20C(220-230V50Hz) 114880	DILMP20C(24VDC) 114885	1 Off
DILM32C-XHI.. DILAC-XHI..	DILM7-10C(220-230V50Hz) 114890	DILM7-10C(24VDC) 114895	1 Off
DILAC-XHI..	DILM7-01C(220-230V50Hz) 114900	DILM7-01C(24VDC) 114905	1 Off
DILM32C-XHI.. DILAC-XHI..	DILM9-10C(220-230V50Hz) 114910	DILM9-10C(24VDC) 114915	1 Off
DILAC-XHI..	DILM9-01C(220-230V50Hz) 114920	DILM9-01C(24VDC) 114925	1 Off
DILM32C-XHI.. DILAC-XHI..	DILM12-10C(220-230V50Hz) 114930	DILM12-10C(24VDC) 114935	1 Off
DILAC-XHI..	DILM12-01C(220-230V50Hz) 114940	DILM12-01C(24VDC) 114945	1 Off
DILM32C-XHI.. DILAC-XHI..	DILM15-10C(220-230V50Hz) 114950	DILM15-10C(24VDC) 114955	1 Off
DILAC-XHI..	DILM15-01C(220-230V50Hz) 114960	DILM15-01C(24VDC) 114965	1 Off
DILM32C-XHI.. DILAC-XHI.. DILM32C-XHI11-S	DILM17-10C(220-230V50Hz) 114970	DILM17-10C(RDC24) 114975	1 Off
DILAC-XHI.. DILM32C-XHI11-S	DILM17-01C(220-230V50Hz) 114980	DILM17-01C(RDC24) 114985	1 Off
DILM32C-XHI.. DILAC-XHI.. DILM32C-XHI11-S	DILM25-10C(220-230V50Hz) 114990	DILM25-10C(RDC24) 114995	1 Off
DILAC-XHI.. DILM32C-XHI11-S	DILM25-01C(220-230V50Hz) 115000	DILM25-01C(RDC24) 115005	1 Off
DILM32C-XHI.. DILAC-XHI.. DILM32C-XHI11-S	DILM32-10C(220-230V50Hz) 115010	DILM32-10C(RDC24) 115015	1 Off
DILAC-XHI.. DILM32C-XHI11-S	DILM32-01C(220-230V50Hz) 115020	DILM32-01C(RDC24) 115025	1 Off
DILM32C-XHI.. DILAC-XHI.. DILM32C-XHI11-S	DILM38-10C(220-230V50Hz) 115030	DILM38-10C(RDC24) 115035	1 Off
DILAC-XHI.. DILM32C-XHI11-S	DILM38-01C(220-230V50Hz) 115040	DILM38-01C(RDC24) 115045	1 Off
DILM150C-XHI.. DILM1000C-XHI..	DILM40C(220-230V50Hz) 115550	DILM40C(RDC24) 115552	1 Off
DILM150C-XHI.. DILM1000C-XHI..	DILM50C(220-230V50Hz) 115564	DILM50C(RDC24) 115566	1 Off
DILM150C-XHI.. DILM1000C-XHI..	DILM65C(220-230V50Hz) 115578	DILM65C(RDC24) 115580	1 Off
DILM150C-XHI.. DILM1000C-XHI..	DILM72C(220-230V50Hz) 112353	DILM72C(RDC24) 112095	1 Off
DILM150C-XHI.. DILM1000C-XHI..	DILM80C(220-230V50Hz) 115592	DILM80C(RDC24) 115594	1 Off
DILM150C-XHI.. DILM1000C-XHI..	DILM95C(220-230V50Hz) 115606	DILM95C(RDC24) 115608	1 Off
DILM150C-XHI.. DILM1000C-XHI..	DILM115C(RAC240) 115620	DILM115C(RDC24) 115621	1 Off
DILM150C-XHI.. DILM1000C-XHI..	DILM150C(RAC240) 115632	DILM150C(RDC24) 115633	1 Off
DILM150C-XHI.. DILM1000C-XHI..	DILM170C(RAC240) 112073	DILM170C(RDC24) 112076	1 Off

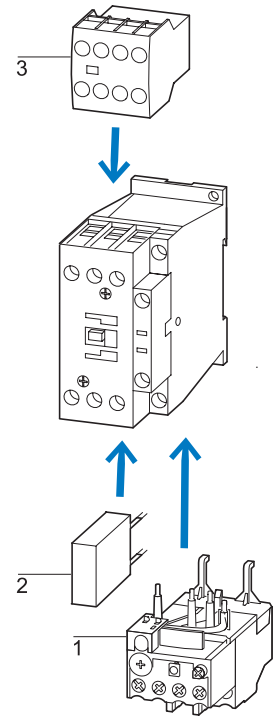

Accessories

- 1 Overload relay → 57
- 2 Suppressor → 32
- 3 Auxiliary contact module → 29
- Operating voltage → 36
- Accessories → 32

Auxiliary contact module to use with	AC operation Part no. Article no.	DC operation Part no. Article no.	Std. pack
	Operating voltage 220-230V50Hz	Operating voltage 24VDC	
DILM32C-XHI.. DILAC-XHI..	DILMP20C(220-230V50Hz) 114880	DILMP20C(24VDC) 114885	1 Off
DILM32C-XHI.. DILAC-XHI..	DILM7-10C(220-230V50Hz) 114890	DILM7-10C(24VDC) 114895	1 Off
DILAC-XHI..	DILM7-01C(220-230V50Hz) 114900	DILM7-01C(24VDC) 114905	1 Off
DILM32C-XHI.. DILAC-XHI..	DILM9-10C(220-230V50Hz) 114910	DILM9-10C(24VDC) 114915	1 Off
DILAC-XHI..	DILM9-01C(220-230V50Hz) 114920	DILM9-01C(24VDC) 114925	1 Off
DILM32C-XHI.. DILAC-XHI..	DILM12-10C(220-230V50Hz) 114930	DILM12-10C(24VDC) 114935	1 Off
DILAC-XHI..	DILM12-01C(220-230V50Hz) 114940	DILM12-01C(24VDC) 114945	1 Off
DILM32C-XHI.. DILAC-XHI..	DILM15-10C(220-230V50Hz) 114950	DILM15-10C(24VDC) 114955	1 Off
DILAC-XHI..	DILM15-01C(220-230V50Hz) 114960	DILM15-01C(24VDC) 114965	1 Off
DILM32C-XHI.. DILAC-XHI.. DILM32C-XHI11-S	DILM17-10C(220-230V50Hz) 114970	DILM17-10C(RDC24) 114975	1 Off
DILAC-XHI.. DILM32C-XHI11-S	DILM17-01C(220-230V50Hz) 114980	DILM17-01C(RDC24) 114985	1 Off
DILM32C-XHI.. DILAC-XHI.. DILM32C-XHI11-S	DILM25-10C(220-230V50Hz) 114990	DILM25-10C(RDC24) 114995	1 Off
DILAC-XHI.. DILM32C-XHI11-S	DILM25-01C(220-230V50Hz) 115000	DILM25-01C(RDC24) 115005	1 Off
DILM32C-XHI.. DILAC-XHI.. DILM32C-XHI11-S	DILM32-10C(220-230V50Hz) 115010	DILM32-10C(RDC24) 115015	1 Off
DILAC-XHI.. DILM32C-XHI11-S	DILM32-01C(220-230V50Hz) 115020	DILM32-01C(RDC24) 115025	1 Off
DILM32C-XHI.. DILAC-XHI.. DILM32C-XHI11-S	DILM38-10C(220-230V50Hz) 115030	DILM38-10C(RDC24) 115035	1 Off
DILAC-XHI.. DILM32C-XHI11-S	DILM38-01C(220-230V50Hz) 115040	DILM38-01C(RDC24) 115045	1 Off
DILM150C-XHI.. DILM1000C-XHI..	DILM40C(220-230V50Hz) 115550	DILM40C(RDC24) 115552	1 Off
DILM150C-XHI.. DILM1000C-XHI..	DILM50C(220-230V50Hz) 115564	DILM50C(RDC24) 115566	1 Off
DILM150C-XHI.. DILM1000C-XHI..	DILM65C(220-230V50Hz) 115578	DILM65C(RDC24) 115580	1 Off
DILM150C-XHI.. DILM1000C-XHI..	DILM72C(220-230V50Hz) 112353	DILM72C(RDC24) 112095	1 Off
DILM150C-XHI.. DILM1000C-XHI..	DILM80C(220-230V50Hz) 115592	DILM80C(RDC24) 115594	1 Off
DILM150C-XHI.. DILM1000C-XHI..	DILM95C(220-230V50Hz) 115606	DILM95C(RDC24) 115608	1 Off
DILM150C-XHI.. DILM1000C-XHI..	DILM115C(RAC240) 115620	DILM115C(RDC24) 115621	1 Off
DILM150C-XHI.. DILM1000C-XHI..	DILM150C(RAC240) 115632	DILM150C(RDC24) 115633	1 Off
DILM150C-XHI.. DILM1000C-XHI..	DILM170C(RAC240) 112073	DILM170C(RDC24) 112076	1 Off

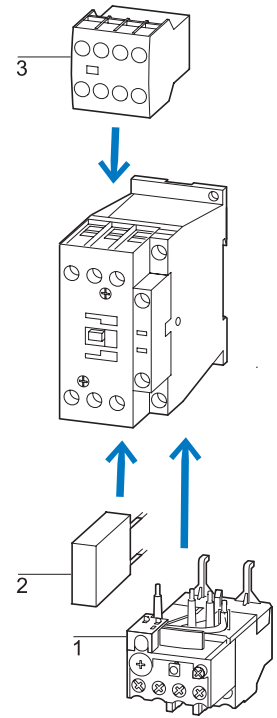

Accessories

- 1 Overload relay → 57
- 2 Suppressor → 32
- 3 Auxiliary contact module → 29
- Operating voltage → 36
- Accessories → 32





1.3

Contactor DILM.C Auxiliary contact modules

1

Auxiliary contact modules

With interlocked opposing contacts (except XHIV and XHICV)



	Conventional thermal current $I_{th} = I_e$ AC-1 at 60°C Open	Contact N/O = Normally open contact N/O _E = N/O, early-make N/C = Normally closed contact N/C _L = N/C, late-break	Circuit symbol	For use with	Part no. Article no.	Std. pack
2 pole Screw terminals Top mounting auxiliary contacts¹⁾ 	16	1 N/O 1 N/C		DILM7-10C... DILM9-10C...	DILM32C-XHI11 115048	5 Off
	16	— 2 N/C		DILM12-10C... DILM15-10C... DILM17-10C... DILM25-10C... DILM32-10C... DILM38-10C...	DILM32C-XHI02 115049	5 Off
	16	2 N/O 2 N/C			DILM32C-XHI22 115050	5 Off
4 pole Screw terminals Top mounting auxiliary contacts¹⁾ 	16	3 N/O 1 N/C			DILM32C-XHI31 115051	5 Off
	16	2 N/O —		DILM7...C... DILM9...C... DILM12...C... DILM15...C... DILM17...C... DILM25...C... DILM32...C... DILM38...C...	DILAC-XHI20 114870	5 Off
2 pole Screw terminals Top mounting auxiliary contacts¹⁾ 	16	1 N/O 1 N/C		DILM12...C... DILM15...C... DILM17...C... DILM25...C... DILM32...C... DILM38...C...	DILAC-XHI11 114871	5 Off
	16	— 2 N/C			DILAC-XHI02 114872	5 Off
	16	1 N/O _E 1 N/C _L			DILA-XHIV11 276423	5 Off
4 pole Screw terminals Top mounting auxiliary contacts¹⁾ 	16	4 N/O —			DILAC-XHI40 114873	5 Off
	16	3 N/O 1 N/C			DILAC-XHI31 114874	5 Off
	16	2 N/O 2 N/C			DILAC-XHI22 114875	5 Off
	16	1 N/O 3 N/C			DILAC-XHI13 114876	5 Off
	16	— 4 N/C			DILAC-XHI04 114877	5 Off
	16	1 N/O, 1 N/O _E 1 N/C, 1 N/C _L			DILA-XHIV22 276427	5 Off
	10	1 N/O 1 N/C		DILM17...C... DILM25...C... DILM32...C... DILM38...C...	DILM32C-XHI11-S 115052	1 Off

Notes

- Top mounting auxiliary contacts have the following characters:
 - Interlocked opposing contacts according to IEC/EN 60947-5-1 Annex L, inside the auxiliary contact modules, also for the integrated auxiliary contacts of the DILM 7C - DILM38C (except N/O early-make and N/C late-break)
 - N/C Auxiliary contacts can be used as mirror contacts according to IEC/EN 60947-4-1, Annex F (except N/C late-breaks)
- Can only be left on the contactor. Cannot be combined with mechanical interlock and top mounting auxiliary contacts.

Auxiliary contact modules

With interlocked opposing contacts (except XHIV and XHICV)

Conventional thermal current $I_{th} = I_e$ AC-1 at 60°C Open	Contact N/O = Normally open contact N/O _E = N/O, early-make N/C = Normally closed contact N/C _L = N/C, late-break	Circuit symbol	For use with	Part no. Article no.	Std. pack	
2 pole Screw terminals Top mounting auxiliary contacts 	10	2 N/O	—	DILM40C... DILM50C...	DILM150C-XHI20 105686	5 Off
	10	1 N/O	1 N/C	DILM65C... DILM72C... DILM80C...	DILM150C-XHI11 105687	5 Off
	10	1 N/O	1 N/C	DILM95C... DILM115C... DILM150C... DILM170C...	DILM150-XHIA11 283463	5 Off
	10	—	2 N/C		DILM150C-XHI02 105688	5 Off
4 pole Screw terminals Top mounting auxiliary contacts 	10	4 N/O	—		DILM150C-XHI40 105689	5 Off
	10	3 N/O	1 N/C		DILM150C-XHI31 105690	5 Off
	10	2 N/O	2 N/C		DILM150C-XHI22 105691	5 Off
	10	2 N/O	2 N/C		DILM150-XHIA22 283464	5 Off
	10	1 N/O	3 N/C		DILM150C-XHI13 105692	5 Off
	10	—	4 N/C		DILM150C-XHI04 105693	5 Off
	10	1 N/O, 1 N/O _E	1 N/C, 1 N/C _L		DILM150-XHIV22 277953	5 Off
2 pole Screw terminals Side-mounting auxiliary contacts 	10	1 N/O	1 N/C	DILM40C... DILM170C	DILM1000C-XHI11-SI 105694	1 Off
	10	1 N/O _E	1 N/C _L	DILM40C... DILM170C	DILM1000-XHIV11-SI 278426	1 Off
	10	1 N/O	1 N/C	DILM80C... DILM170C	DILM1000C-XHI11-SA 105695	1 Off

1.3

Contactor DILM.C Auxiliary contact modules

1 Auxiliary contact modules

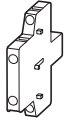

DILM1000C-
XHI11-SI
DILM1000-
XHIV11-SI



DILM1000C-
XHI11-SA



DILM150C-XHI20
DILM150C-XHI11
DILM150C-XHI02



DILM150C-XHI40
DILM150C-XHI31
DILM150C-XHI22
DILM150C-XHI13
DILM150C-XHI04
DILM150C-XHIV22



DILM150-XHIA11



DILM150-XHIA22

DILM40C	2 x	–	–	–	1 x	–
... DILM72C	–	2 x	1 x	–	–	–
	1 x	–	–	–	–	1 x
	–	1 x	–	1 x	–	–
DILM80C	2 x	2 x	–	–	–	–
... DILM170C	2 x	–	–	–	–	1 x
	2 x	–	–	–	1 x	–
	–	2 x	–	1 x	–	–
	–	2 x	1 x	–	–	–

Notes side-mounting auxiliary contacts

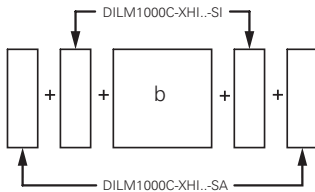
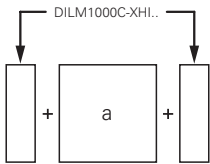





a DILM40C – DILM72C

b DILM80C – DILM170C

- Interlocked opposing contacts according to IEC/EN 60947-5-1 Annex L, inside the auxiliary contact module (except N/O early close and N/C late open)
- Auxiliary contacts can be used as mirror contacts according to IEC/EN 60947-4-1, Annex F (except N/C late open)
- No auxiliary contact is possible between two contactors with mechanical interlock.

Suppressor circuits

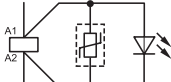
Voltage	For use with	Circuit symbol	Part no. Article no.	Std. pack	Notes	
V						
RC suppressors						
	24 – 48 AC	DILM7..C-DILM15..C DILMP20..C		DILM12-XSPR48 281199	10 Off	For AC operated contactors 50-60Hz. Ac operated DILM 115C, DILM 150C, DILM 170C and all DC operated contactors have an integrated suppressor. Note drop-out delay.
	110 – 240 AC	DILA..C		DILM12-XSPR240 281200	10 Off	
	240 – 500 AC			DILM12-XSPR500 281201	10 Off	
24 – 48 AC	DILM17..C-DILM38..C	DILM32-XSPR48 281202	10 Off			
110 – 240 AC		DILM32-XSPR240 281203	10 Off			
240 – 500 AC		DILM32-XSPR500 281204	10 Off			
24 – 48 AC	DILM40C-DILM95C	DILM95-XSPR48 281205	10 Off			
110 – 240 AC		DILM95-XSPR240 281206	10 Off			
240 – 500 AC		DILM95-XSPR500 281207	10 Off			
Varistor suppressors						
	24 – 48 AC	DILM7..C-DILM15..C DILMP20..C		DILM12-XSPV48 281208	10 Off	For AC operated contactors 50-60Hz. Ac operated DILM 115C, DILM 150C, DILM 170C and all DC operated contactors have an integrated suppressor. Note drop-out delay.
	48 – 130 AC	DILA..C		DILM12-XSPV130 281209	10 Off	
	130 – 240 AC			DILM12-XSPV240 281210	10 Off	
240 – 500 AC		DI LM12-XSPV500 281211	10 Off			
24 – 48 AC	DILM17..C-DILM38..C	DILM32-XSPV48 281212	10 Off			
48 – 130 AC		DILM32-XSPV130 281213	10 Off			
130 – 240 AC		DILM32-XSPV240 281214	10 Off			
240 – 500 AC		DILM32-XSPV500 281215	10 Off			
24 – 48 AC	DILM40C-DILM95C	DILM95-XSPV48 281216	10 Off			
48 – 130 AC		DILM95-XSPV130 281217	10 Off			
130 – 240 AC		DILM95-XSPV240 281218	10 Off			
240 – 500 AC		DILM95-XSPV500 281219	10 Off			
Varistor suppressors with integrated LED						
	24 – 48 AC	DILM7..C-DILM15..C DILMP20..C		DILM12-XSPVL48 281220	10 Off	For AC operated contactors 50-60Hz. Ac operated DILM 115C, DILM 150C, DILM 170C and all DC operated contactors have an integrated suppressor. Note drop-out delay.
	130 – 240 AC	DILA..C		DILM12-XSPVL240 281221	10 Off	
	24 – 48 AC	DILM17..C-DILM38..C		DILM32-XSPVL48 281222	10 Off	
130 – 240 AC		DILM32-XSPVL240 281223	10 Off			
24 – 48 AC	DILM40C-DILM95C	DILM95-XSPVL48 281224	10 Off			
130 – 240 AC		DILM95-XSPVL240 281225	10 Off			

1.3

Contactor DILM..C Accessories

1

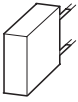

Diode suppressors

Voltage	For use with	Circuit symbol	Part no. Article no.	Std. pack	Notes
V 12 – 250 DC	DILM7..C-DILM15..C DILMP20..C DILA..C		DILM12-XSPD 101672	10 Off	DC operated contactors. Prevention of negative switch-off voltage when the contactor is used together with a safety PLC.

Contactor connector

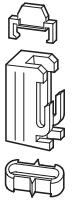
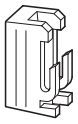

	For use with	Part no. Article no.	Std. pack	Notes
	DILM7..C-DILM72C DILA..C	DILM32-XVB 281227	50 Off	For mechanically linking contactors in combinations 0 mm distance between contactors.
	DILM80C-DILM170C	DILM150-XVB 281226	10 Off	For mechanically linking contactors in combinations 0 mm distance between contactors.

Mechanical interlocks, incl. contactor connector

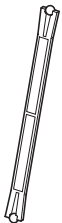

	For use with	Part no. Article no.	Std. pack	Notes
	DILM7..C-DILM15..C DILMP20...C DILA...C	DILM12-XMV 281196	1 Off	For two contactors with AC or DC operation arranged vertically or horizontally. Distance between contactors 0 mm, including contactor connector.
	DILM17..C-DILM38..C	DILM32-XMV 281197	1 Off	Mechanical lifespan 2.5 x 10 ⁶ operations.
	DILM40C-DILM72C	DILM65-XMV 281198	1 Off	Additional auxiliary contact modules possible.
	DILM80C-DILM170C	DILM150-XMV 240081	1 Off	

Paralleling links for main contacts

Consisting of 2 paralleling links

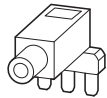
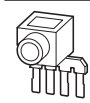

For use with	Part no. Article no.	Std. pack	Notes
DILM7..C-DILM15..C	DILM12-XP1 281193	5 Off	4th pole can be broken off AC-1 current carrying capacity of the open contactor increases by a factor of 2.5. Protected against accidental contact in accordance with IEC536 Connection cross section for DILM...XP1 Technical Data → "Technical Data"
DILM17..C-DILM38..C	DILM32-XP1 281194	5 Off	
DILM40C-DILM72C	DILM65-XP1 281195	5 Off	
DILM80C-DILM170C	DILM150-XP1 284769	5 Off	



Star-point bridges

For use with	Part no. Article no.	Std. pack	Notes
DILM7..C-DILM15..C	DILM12-XS1 281190	20 Off	Designed as tool-less plug connection
DILM17..C-DILM38..C	DILM32-XS1 281191	20 Off	–
DILM40C-DILM72C	DILM65-XS1 281192	20 Off	–
DILM80C-DILM170C	DILM150-XS1 284768	20 Off	–

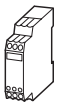

Amplifier module for separate mounting

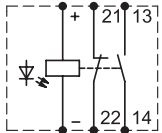

Amplifier module for separate mounting.
Input with integrated suppressor circuit for over-voltage limitation

Rated operational current			Actuating voltages	Actuating current	Circuit symbol	For use with	Part no. Article no.	Std. pack
AC-15		DC						
240 V	415 V	220 V	U_s	I				
I_e	I_e	I_e	V DC	mA				
A	A	A						
2	2	0.03	24	25		As required	ETS4-VS3 083094	1 Off

Notes

- Contactor coils with rated operational current > 2A must be actuated via the DILA...C contactor relay.
- Rated operational current DC: making and breaking conditions DC-13, time L/R 300ms

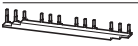
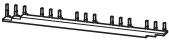
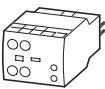
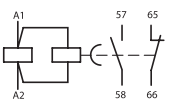
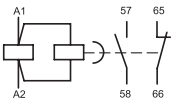
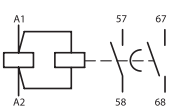
1 Accessories

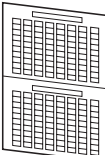
	For use with	Circuit symbol	Part no. Article no.	Std. pack	Notes
Three-phase comming links					
Protected against accidental contact, short-circuit proof $U_g = 690\text{ V}$, $I_u = 35\text{ A}$					
	DILM7..C DILM9..C	—	DILM12-XDSB0/3 240084	5 Off	Suitable for 3 contactors. Length 135 mm
	DILM12..C DILM15..C	—	DILM12-XDSB0/4 240085	5 Off	Suitable for 4 contactors. Length 180 mm
	—	—	DILM12-XDSB0/5 240086	5 Off	Suitable for 5 contactors. Length 225 mm
Electronic timer modules					
					
On-delayed					
24 V AC/DC	DILM7..C-DILM32..C DILMP20C		DILM32-XTEE11(RA24) 101440	1 Off	Time range 0.05 s...1 s
100 ... 130 V AC	DILA..C		DILM32-XTEE11(RAC130) 101441	1 Off	Time range 0.5 s...10 s
200 ... 240 V AC	—		DILM32-XTEE11(RAC240) 101442	1 Off	Time range 5 s...100 s
Off-delayed					
24 V AC/DC	DILM7..C-DILM32..C DILMP20C		DILM32-XTED11-1(RA24) 105210	1 Off	Time range 0.05 s...1 s
24 V AC/DC	DILA..C		DILM32-XTED11-10(RA24) 104943	1 Off	Time range 0.5 s...10 s
24 V AC/DC	—		DILM32-XTED11-100(RA24) 104946	1 Off	Time range 5 s...100 s
100 ... 130 V AC	—		DILM32-XTED11-1(RAC130) 105211	1 Off	Time range 0.05 s...1 s
100 ... 130 V AC	—		DILM32-XTED11-10(RAC130) 104944	1 Off	Time range 0.5 s...10 s
100 ... 130 V AC	—		DILM32-XTED11-100(RAC130) 104947	1 Off	Time range 5 s...100 s
200 ... 240 V AC	—		DILM32-XTED11-1(RAC240) 105212	1 Off	Time range 0.05 s...1 s
200 ... 240 V AC	—		DILM32-XTED11-10(RAC240) 104945	1 Off	Time range 0.5 s...10 s
200 ... 240 V AC	—		DILM32-XTED11-100(RAC240) 104948	1 Off	Time range 5 s...100 s
For star-delta applications					
24 V AC/DC	DILM7..C-DILM32..C DILMP20C		DILM32-XTEY20(RA24) 101446	1 Off	Changeover time: 1 s...30 s
100 ... 130 V AC	DILA..C		DILM32-XTEY20(RAC130) 101447	1 Off	Changeover delay: 50 ms
200 ... 240 V AC	—		DILM32-XTEY20(RAC240) 101448	1 Off	Changeover delay: 50 ms
Sealable shrouds					
Transparent					
	DILM32-XTE...	—	DILM32-XTEPLH 101449	1 Off	—
label sheet					
Self-adhesive label sheet					
	Labelling with laser printer, plotter, film plotter, copier	—	XGKE-GE 207517	25 Off	1 off = 1 sheet 240 labels per sheet 1 sheet = DIN A4 Can be split into two DIN A5

AC

	DILMP20C (...)	DILM7-10C (...)	DILM7-01C (...)	DILM9-10C (...)	DILM9-01C (...)	DILM12-10C (...)	DILM12-01C (...)	DILM15-10C (...)	DILM15-01C (...)
	Article no. ¹⁾	Article no. ¹⁾	Article no. ¹⁾	Article no. ¹⁾	Article no. ¹⁾	Article no. ¹⁾	Article no. ¹⁾	Article no. ¹⁾	Article no. ¹⁾
Standard voltage									
24V 50Hz	114878	114888	114898	114908	114918	114928	114938	114948	114958
110V 50Hz	114879	114889	114899	114909	114919	114929	114939	114949	114959
220V-230V 50Hz	114880	114890	114900	114910	114920	114930	114940	114950	114960
380-400V 50Hz	114881	114891	114901	114911	114921	114931	114941	114951	114961
24V 50/60Hz	114882	114892	114902	114912	114922	114932	114942	114952	114962
110V 50/60Hz	114883	114893	114903	114913	114923	114933	114943	114953	114963
220V 50/60Hz	114884	114894	114904	114914	114924	114934	114944	114954	114964

DC

	DILMP20C (...)	DILM7-10C (...)	DILM7-01C (...)	DILM9-10C (...)	DILM9-01C (...)	DILM12-10C (...)	DILM12-01C (...)	DILM15-10C (...)	DILM15-01C (...)
	Article no. ¹⁾	Article no. ¹⁾	Article no. ¹⁾	Article no. ¹⁾	Article no. ¹⁾	Article no. ¹⁾	Article no. ¹⁾	Article no. ¹⁾	Article no. ¹⁾
Standard voltage									
24VDC	114885	114895	114905	114915	114925	114935	114945	114955	114965
110VDC	114886	114896	114906	114916	114926	114936	114946	114956	114966
220VDC	114887	114897	114907	114917	114927	114937	114947	114957	114967

Notes 1) The article number is a combination of part no. and operating voltage.

AC

	DILM17-10C (...)	DILM17-01C (...)	DILM25-10C (...)	DILM25-01C (...)	DILM32-10C (...)	DILM32-01C (...)	DILM38-10C (...)	DILM38-01C (...)
	Article no. ¹⁾	Article no. ¹⁾	Article no. ¹⁾	Article no. ¹⁾	Article no. ¹⁾	Article no. ¹⁾	Article no. ¹⁾	Article no. ¹⁾
Standard voltage								
24V 50Hz	114968	114978	114988	114998	115008	115018	115028	115038
110V 50Hz	114969	114979	114989	114999	115009	115019	115029	115039
220V-230V 50Hz	114970	114980	114990	115000	115010	115020	115030	115040
380-400V 50Hz	114971	114981	114991	115001	115011	115021	115031	115041
24V 50/60Hz	114972	114982	114992	115002	115012	115022	115032	115042
110V 50/60Hz	114973	114983	114993	115003	115013	115023	115033	115043
220V 50/60Hz	114974	114984	114994	115004	115014	115024	115034	115044

DC

	DILM17-10C (...)	DILM17-01C (...)	DILM25-10C (...)	DILM25-01C (...)	DILM32-10C (...)	DILM32-01C (...)	DILM38-10C (...)	DILM38-01C (...)
	Article no. ¹⁾	Article no. ¹⁾	Article no. ¹⁾	Article no. ¹⁾	Article no. ¹⁾	Article no. ¹⁾	Article no. ¹⁾	Article no. ¹⁾
Standard voltage								
RDC 24²⁾	114975	114985	114995	115005	115015	115025	115035	115045
RDC 130³⁾	114976	114986	114996	115006	115016	115026	115036	115046
RDC 240⁴⁾	114977	114987	114997	115007	115017	115027	115037	115047

Notes 1) The article number is a combination of part no. and operating voltage.

2) 24-27 V DC

3) 110-130 V DC

4) 200-240 V DC

1.3

Contactor DILM..C

Actuating voltages, basic devices

1 AC

	DILM40C (...)	DILM50C (...)	DILM65C (...)	DILM72C (...)	DILM80C (...)	DILM95C (...)
	Article no. ¹⁾	Article no. ¹⁾	Article no. ¹⁾	Article no. ¹⁾	Article no. ¹⁾	Article no. ¹⁾
Standard voltage						
24V 50Hz	105198	105562	105576	102091	105590	105604
110V 50Hz	105199	105563	105577	112352	105591	105605
220V-230V 50Hz	105550	105564	105578	112353	105592	105606
380-400V 50Hz	105551	105565	105579	112354	105593	105607
24V 50/60Hz	112080	112083	112086	112090	112099	112102
110V 50/60Hz	112078	112081	112084	112087	112097	112100
220V 50/60Hz	112079	112082	112085	112088	112098	112101

DC

	DILM40C (...)	DILM50C (...)	DILM65C (...)	DILM72C (...)	DILM80C (...)	DILM95C (...)
	Article no. ¹⁾	Article no. ¹⁾	Article no. ¹⁾	Article no. ¹⁾	Article no. ¹⁾	Article no. ¹⁾
Standard voltage						
RDC 24²⁾	105552	105566	105580	112095	105594	105608
RDC 130³⁾	105553	105567	105581	112094	105595	105609
RDC 240⁴⁾	105554	105568	105582	112096	105596	105610

- Notes**
- 1) The article number is a combination of part no. and operating voltage.
 - 2) 24-27 V DC
 - 3) 110-130 V DC
 - 4) 200-240 V DC

AC

	DILM115C (...)	DILM150C (...)	DILM170C (...)
	Article no. ¹⁾	Article no. ¹⁾	Article no. ¹⁾
Standard voltage			
RDC 24²⁾	105618	105630	112072
RDC 120³⁾	105619	105631	112071
RDC 240⁴⁾	105620	105632	112073
RDC 440⁵⁾	111474	111475	112074

DC

	DILM115C (...)	DILM150C (...)	DILM170C (...)
	Article no. ¹⁾	Article no. ¹⁾	Article no. ¹⁾
Standard voltage			
RDC 24⁶⁾	105621	105633	112076
RDC 130⁷⁾	105622	105634	112075
RDC 240⁸⁾	105623	105635	112077

- Notes**
- 1) The article number is a combination of part no. and operating voltage.
 - 2) 24 V 50/60Hz
 - 3) 100-120 V 50/60Hz
 - 4) 190-240 V 50/60Hz
 - 5) 380-440 V 50/60Hz
 - 6) 24-27 V DC
 - 7) 110-130 V DC
 - 8) 200-240 V DC

AC

	DILM65C-XSP (...)	DILM95C-XSP (...)	DILM150C-XSP (...)
	Article no. ¹⁾	Article no. ¹⁾	Article no. ¹⁾
Standard voltage			
24V 50Hz	115053	115063	
110V 50Hz	115054	115064	
220V-230V 50Hz	115055	115065	
380-400V 50Hz	115056	115066	
24V 50/60Hz	115057	115067	
110V 50/60Hz	115058	115068	
220V 50/60Hz	115059	115069	
RAC 24²⁾			115073
RAC 120³⁾			115074
RAC 240⁴⁾			115075
RAC 440⁵⁾			115076

DC

	DILM65C-XSP (...)	DILM95C-XSP (...)	DILM150C-XSP (...)
	Article no. ¹⁾	Article no. ¹⁾	Article no. ¹⁾
Standard voltage			
24VDC			
110VDC			
220VDC			
RDC 24⁶⁾	115060	115070	115077
RDC 130⁷⁾	115061	115071	115078
RDC 240⁸⁾	115062	115072	115079

- Notes**
- 1) The article number is a combination of part no. and operating voltage.
 - 2) 24 V 50/60Hz
 - 3) 100-120 V 50/60Hz
 - 4) 190-240 V 50/60Hz
 - 5) 380-440 V 50/60Hz
 - 6) 24-27 V DC
 - 7) 110-130 V DC
 - 8) 200-240 V DC

1.3

Contactors DILM..C Contact travel diagrams

1 Contactor contact travel diagrams

The diagrams show the closing and opening travel of the contacts at no load.

DILM7...C/9...C/12...C/15...C/P20-...AC

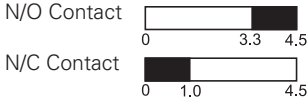

DILM7...C/9...C-...DC

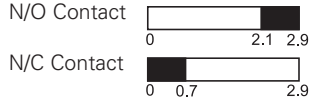

DILM12...C/15...C/P20-...DC

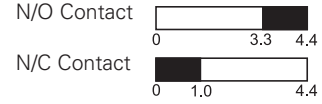

DILM32C-XHI(C)...

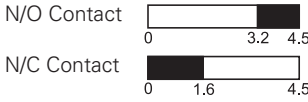

DILM32C-XHI(C)...

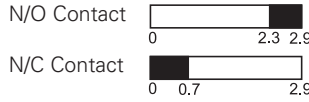

DILM32C-XHI(C)...

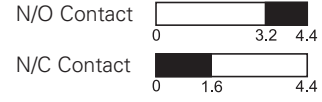

DILAC-XHI(C)V...

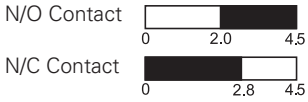

DILAC-XHI(C)V...

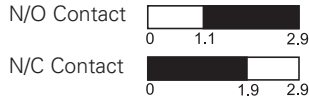

DILAC-XHI(C)V...

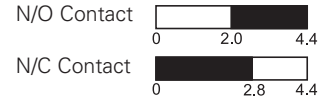

DILM17...C/25...C/32...C/38...C

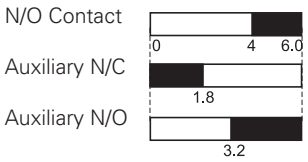

DILM40C/50C/65C/72...C

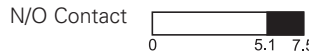

DILM80C/95C/115C/150C/170C



DILM32C-XHI(C)..., DILA-XHI(C)...

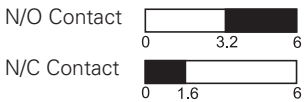

DILM150C-XHI(C)...

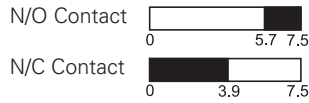

DILM150C-XHI(C)...

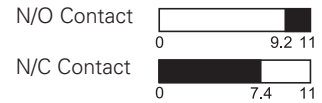

DILAC-XHI(C)V...

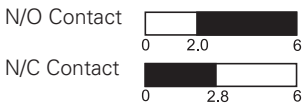

DILM150C-XHI(C)V...

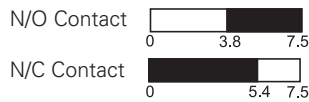

DILM150C-XHI(C)V...

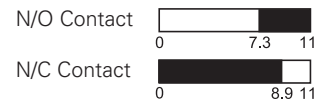

DILM1000C-XHI(C)...

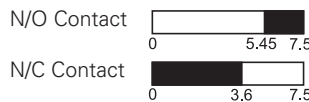

DILM1000C-XHI(C)...

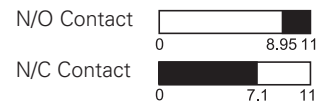

DILM1000C-XHI(C)V...

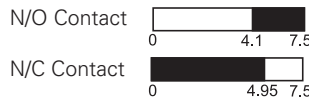

DILM1000C-XHI(C)V...

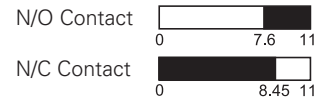

Normal switching duty

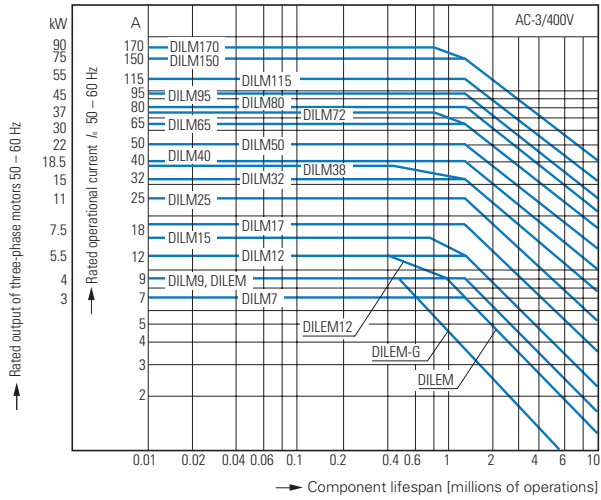

Squirrel-cage motor

- Operating characteristics:
 - Switch on: From standstill
 - Switch off: While running
- Electrical Characteristic:
 - Switch on: Up to 6 x motor rated current
 - Switch off: 1 x motor rated current
- Utilization category:
 - 100 % AC-3
- Typical applications:

Compressors	Lifts	Mixers
Pumps	Escalators	Agitators
Fans	Conveyor belts	Centrifuges
Hinged flaps	Bucket-elevator	Air-conditioning system
- General drives for manufacturing and processing machines

Extreme switching duty

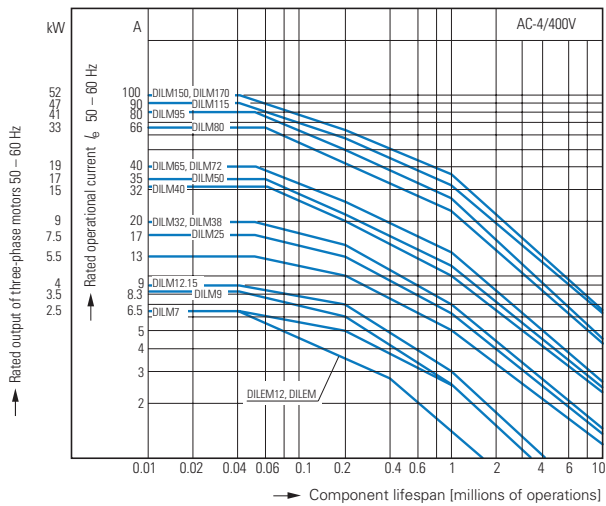

Squirrel-cage motor

- Operating characteristics:
 - Inching, DC braking, reversing
- Electrical characteristic:
 - Switch on: 6 x motor rated current
 - Switch off: 6 x motor rated current
- Utilization category:
 - 100 % AC-4
- Typical applications:

Printing machines	Wire-drawing	Centrifuges
-------------------	--------------	-------------
- Special drives for machining centers and machine tools

1.3

Contactor DILM..C engineering

Contactors for resistive load, enclosures

1 Rating data

Single-phase rating AC-1

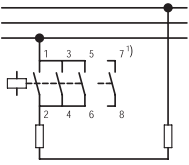

Voltage: V			Rated operational current $I_e = I_{th}$ or I_{the}
220	380	660	
230	400	690	

kW	kW	kW	A	Part no.	Page	Required accessories:	Notes
						Paralleling links	
						Part no.	
Open							
8	14	25	22	DILM7..C	Page 28	DILM12-XP1	Accessories Page
8	14	25	22	DILM9..C	Page 28	DILM12-XP1	Paralleling links → 34
8	14	25	22	DILM12..C	Page 28	DILM12-XP1	Accessories → 32
8	14	25	22	DILM15..C	Page 28	DILM12-XP1	Auxiliary contact modules → 29
15	26	45	40	DILM17..C	Page 28	DILM32-XP1	
17	29	51	45	DILM25..C	Page 28	DILM32-XP1	
17	29	51	45	DILM32..C	Page 28	DILM32-XP1	
17	29	51	45	DILM38..C	Page 28	DILM32-XP1	
22	39	68	60	DILM40C	Page 28	DILM65-XP1	
30	53	91	80	DILM50C	Page 28	DILM65-XP1	
37	65	111	98	DILM65C	Page 28	DILM65-XP1	
37	65	111	98	DILM72C	Page 28	DILM65-XP1	
42	72	125	110	DILM80C	Page 28	DILM150-XP1	
49	85	148	130	DILM95C	Page 28	DILM150-XP1	
61	105	182	160	DILM115C	Page 28	DILM150-XP1	
72	125	216	190	DILM150C	Page 28	DILM150-XP1	
85	150	268	225	DILM170C	Page 28	DILM150-XP1	

Notes 1) Contact 7 – 8 only with DILMP20C

Enclosures

Contactors

Contactor selection

Part no.	Contactor selection			Insulated enclosures
	With top mounting auxiliary contacts	With side-mounting auxiliary contacts	With overload relay	
DILM7..C-DILM15..C	●	–	–	CI-K2-145-TS
DILM7..C-DILM15..C	●	–	●	CI-K3-160-TS
DILM17..C-DILM38..C	–	–	–	CI-K2-145-TS
DILM17..C-DILM38..C	●	–	●	CI23E-150
DILM40C-DILM72C	–	●	–	CI-K3-160-TS
DILM40C-DILM72C	●	●	●	CI43E-150
DILM80C-DILM170C	●	●	–	CI43E-200
DILM80C-DILM170C	●	●	●	CI44E-200

Determination of the maximum operating frequency dependent on the rating and utilization category (recommended values for 400 V)

P_N = max. rated motor output (kW) of respective contactor according to Page 23
 S/h = max. operation per hour

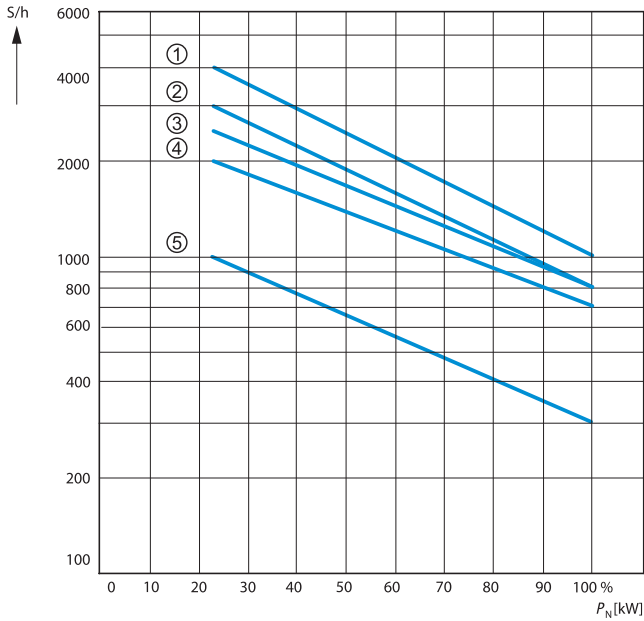

Part no.	Characteristic		
	AC-1	AC-3	AC-2 AC-4
DILM7..C-DILM15..C	3	1	5
DILM17..C-DILM38..C	3	2	5
DILM40C-DILM72C	3	2	5
DILM80C-DILM170C	3	4	5

DC current switching

----- when necessary
 conductor to be
 supplied by customer

DILM7..C-DILM170C

Without overload relay
 ≤ 60 V DC

> 60 V DC

With overload relay
 > 60 V DC

1 pole

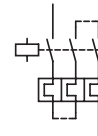

2 pole

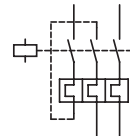

DILMP20C

1 pole

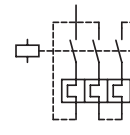
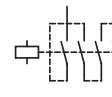

2 pole

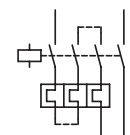

1.3

Contactor DILM..C

Technical data

1 Technical data

			DILM7..C	DILM9..C	DILM12..C DILMP20C	DILM15..C	DILM17..C	DILM25..C	DILM32..C DILM38..C
General									
Standard	IEC/EN 60947, VDE 0660, GB14048								
Lifespan, mechanical									
AC operated	Operations	$\times 10^6$	10	10	10	10	10	10	10
DC operated	Operations	$\times 10^6$	10	10	10	10	10	10	10
Mechanical operating frequency									
AC operated	Operations/h		9000	9000	9000	5000	5000	5000	5000
DC operated	Operations/h		9000	9000	9000	5000	5000	5000	5000
Maximum operating frequency									
Electrical (contactors without overload relays)	See characteristic curves on page 42								
Climatic proofing									
Damp heat, constant, to IEC 60068-2-78; Damp heat, cyclic, to IEC 60068-2-30									
Ambient temperature									
Open		°C	-25...60	-25...60	-25...60	-25...60	-25...60	-25...60	-25...60
Enclosed		°C	-25...40	-25...40	-25...40	-25...40	-25...40	-25...40	-25...40
For storage		°C	-40...80	-40...80	-40...80	-40...80	-40...80	-40...80	-40...80
Mounting position, AC/DC operated									
Mechanical shock resistance (IEC/EN 60068-2-27)									
Half-sinusoidal shock 10 ms									
Main contacts									
N/O		g	10	10	10	10	10	10	10
Auxiliary contacts									
N/O		g	7	7	7	7	7	7	7
N/O		g	5	5	5	5	5	5	5
Mechanical shock resistance (IEC/EN 60068-2-27)									
Half-sinusoidal shock 10 ms									
Main contacts									
N/O		g	5.7	5.7	5.7	5.7	6.9	6.9	6.9
Auxiliary contacts									
N/O		g	3.4	3.4	3.4	3.4	5.3	5.3	5.3
N/C		g	3.4	3.4	3.4	3.4	3.5	3.5	3.5
Protection type									
Protection against direct contact when actuated from front (EN 50274)									
Finger- and back-of-hand proof									
Weight									
AC operated		kg	0.23	0.23	0.23	0.23	0.42	0.42	0.42
DC operated		kg	0.28	0.28	0.28	0.28	0.48	0.48	0.48
Terminal capacity									
Main circuit cross-section									
Solid		mm ²	1 × (0.75 – 4) 2 × (0.75 – 2.5)				1 × (0.75 – 16) 2 × (0.75 – 10)		
Flexible with ferrule		mm ²	1 × (0.75 – 2.5) 2 × (0.75 – 2.5)				1 × (0.75 – 16) 2 × (0.75 – 10)		
Stranded		mm ²	–	–	–	–	1 × 16	1 × 16	1 × 16
Solid or stranded		AWG	18 – 10	18 – 10	18 – 10	18 – 10	16 – 8	16 – 8	16 – 8
Control circuit cross-section									
Solid		mm ²	1 × (0.75 – 4) 2 × (0.75 – 2.5)				1 × (0.75 – 4) 2 × (0.75 – 4)		
Flexible with ferrule		mm ²	1 × (0.75 – 2.5) 2 × (0.75 – 2.5)				1 × (0.75 – 2.5) 2 × (0.75 – 2.5)		
Solid or stranded		AWG	18 – 10	18 – 10	18 – 10	18 – 10	18 – 14	18 – 14	18 – 14

DILM40C	DILM50C	DILM65C DILM72C	DILM80C	DILM95C	DILM115C	DILM150C DILM170C
IEC/EN 60947, VDE 0660, GB14048						
10	10	10	10	10	10	10
10	10	10	10	10	10	10
5000	5000	5000	3600	3600	3600	3600 3000
5000	5000	5000	3600	3600	3600	3600 3000
See characteristic curves on page 42						
Damp heat, constant, to IEC 60068-2-78;						
Damp heat, cyclic, to IEC 60068-2-30						
-25...60	-25...60	-25...60	-25...60	-25...60	-25...60	-25...60
-25...40	-25...40	-25...40	-25...40	-25...40	-25...40	-25...40
-40...80	-40...80	-40...80	-40...80	-40...80	-40...80	-40...80
10	10	10	10	10	10	10
7	7	7	7	7	7	7
5	5	5	5	5	5	5
-	-	-	-	-	-	-
-	-	-	-	-	-	-
-	-	-	-	-	-	-
IP00	IP00	IP00	IP00	IP00	IP00	IP00
Finger- and back-of-hand proof						
0.9	0.9	0.9	2	2	2	2
1.1	1.1	1.1	2.1	2.1	2.1	2.1
1 × (0.75 – 16) 2 × (0.75 – 10)			–			
1 × (0.75 – 35) 2 × (0.75 – 25)			1 × (10 – 95) 2 × (10 – 70)			
1 × (16 – 50) 2 × (16 – 35)			1 × (16 – 95) 2 × (16 – 70)			
12 – 2	12 – 2	12 – 2	8 – 3/0	8 – 3/0	8 – 3/0	8 – 3/0
1 × (0.75 – 4) 2 × (0.75 – 4)			1 × (0.75 – 4) 2 × (0.75 – 4)			
1 × (0.75 – 2.5) 2 × (0.75 – 2.5)			1 × (0.75 – 2.5) 2 × (0.75 – 2.5)			
18 – 14	18 – 14	18 – 14	18 – 14	18 – 14	18 – 14	18 – 14

1 Technical data

			DILM7..C	DILM9..C	DILM12..C DILMP20C	DILM15..C	DILM17..C	DILM25..C	
General									
Main cable connection screw/bolt			M3.5	M3.5	M3.5	M3.5	M5	M5	
Tightening torque	Nm		1.2	1.2	1.2	1.2	3	3	
Control circuit cable connection screw/bolt			M3.5	M3.5	M3.5	M3.5	M3.5	M3.5	
Tightening torque	Nm		1.2	1.2	1.2	1.2	1.2	1.2	
Tools									
Main circuits									
Pozidriv screwdriver	Size		2	2	2	2	2	2	
Flat-blade screwdriver	mm		0.8 × 5.5 1 × 6	0.8 × 5.5 1 × 6	0.8 × 5.5 1 × 6	0.8 × 5.5 1 × 6	0.8 × 5.5 1 × 6	0.8 × 5.5 1 × 6	
Control circuits									
Pozidriv screwdriver	Size		2	2	2	2	2	2	
Flat-blade screwdriver	mm		0.8 × 5.5 1 × 6	0.8 × 5.5 1 × 6	0.8 × 5.5 1 × 6	0.8 × 5.5 1 × 6	0.8 × 5.5 1 × 6	0.8 × 5.5 1 × 6	
Main contacts									
Rated impulse withstand voltage	U_{imp}	V AC	8000	8000	8000	8000	8000	8000	
Over-voltage category/degree of pollution			III/3	III/3	III/3	III/3	III/3	III/3	
Rated insulation voltage	U_i	V AC	690	690	690	690	690	690	
Rated operational voltage	U_e	V AC	690	690	690	690	690	690	
Safe isolation according to EN 61140									
Between coil and contacts		V AC	440	440	440	440	440	440	
Between the contacts		V AC	440	440	440	440	440	440	
Making capacity of up to 440 V (cos as specified in IEC/EN 60947)	To 690 V	A	112	112	144	155	238	350	
Breaking capacity cos as specified in IEC/EN 60947	220/230 V	A	70	90	120	124	170	250	
	380-400 V	A	70	90	120	124	170	250	
	500 V	A	50	70	100	100	170	250	
	660/690 V	A	40	50	70	70	120	150	
Devices lifespan	I_e AC-1 400 V × 10 ⁶	Op.	0.6	0.6	0.6	0.6	0.6	0.6	
	I_e AC-3 400 V × 10 ⁶	Op.	2	2	2	1	2	2	
	I_e AC-4 400 V × 10 ⁶	Op.	0.2	0.2	0.2	0.2	0.2	0.2	
Max. operating frequency	I_e AC-1 400 V	Op./h	800	800	800	800	800	800	
	I_e AC-3 400 V	Op./h	800	800	800	800	800	800	
	I_e AC-4 400 V	Op./h	250	250	250	250	250	250	
Short-circuit rating									
Short-circuit protection rating maximum fuse									
Type "2" coordination	400 V	gG/gL 500 V	A	20	20	20	20	35	35
	690 V	gG/gL 690 V	A	16	16	20	20	35	35
Type "1" coordination	400 V	gG/gL 500 V	A	35	35	35	63	63	100
	690 V	gG/gL 690 V	A	20	20	25	50	50	50

DILM32..C DILM38..C	DILM40C	DILM50C	DILM65C DILM72C	DILM80C	DILM95C	DILM115C	DILM150C	DILM170C
M5	M6	M6	M6	M10	M10	M10	M10	M10
3	3	3	3	14	14	14	14	14
M3.5	M3.5	M3.5	M3.5	M3.5	M3.5	M3.5	M3.5	M3.5
1.2	1.2	1.2	1.2	1.2	1.2	1.2	1.2	1.2
2	2	2	2	–	–	–	–	–
0.8 × 5.5 1 × 6	0.8 × 5.5 1 × 6	0.8 × 5.5 1 × 6	0.8 × 5.5 1 × 6	–	–	–	–	–
2	2	2	2	2	2	2	2	2
0.8 × 5.5 1 × 6	0.8 × 5.5 1 × 6	0.8 × 5.5 1 × 6	0.8 × 5.5 1 × 6	0.8 × 5.5 1 × 6	0.8 × 5.5 1 × 6	0.8 × 5.5 1 × 6	0.8 × 5.5 1 × 6	0.8 × 5.5 1 × 6
8000	8000	8000	8000	8000	8000	8000	8000	8000
III/3	III/3	III/3	III/3	III/3	III/3	III/3	III/3	III/3
690	690	690	690	690	690	690	690	690
690	690	690	690	690	690	690	690	690
440	440	440	440	440	440	440	440	440
440	440	440	440	440	440	440	440	440
384	560	700	910	1120	1330	1610	2100	2100
320	400	500	650	800	950	1150	1500	1500
320	400	500	650	800	950	1150	1500	1500
320	400	500	650	800	950	1150	1500	1500
180	250	320	370	650	800	1100	1200	1320
0.6	0.6	0.6	0.6	0.6	0.6	0.6	0.6	0.6
2	2	2	2	2	2	2	2	1
1			1					
0.2	0.2	0.2	0.2	0.2	0.2	0.2	0.2	0.2
800	800	800	800	800	800	800	800	800
800	800	800	800	800	800	800	800	800
250	250	250	250	250	250	250	250	250
63	63	80	125	160	160	250	250	400
35	50	63	80	160	160	250	250	250
125	125	160	250	250	250	250	250	400
63	80	80	100	200	200	250	250	250

1.3

Contactor DILM..C

Technical data

1 Technical data

			DILM7..C	DILM9..C	DILM12..C DILMP20C	DILM15..C	DILM17..C	DILM25..C	DILM32..C		
AC voltage											
AC-1 operation											
Conventional thermal current 3 pole 50 - 60 Hz	Open	at 40 °C	I_{th}	A	22	22	22	22	40	45	45
		at 50 °C	I_{th}	A	21	21	21	21	38	43	43
	Enclosed ¹⁾	at 60 °C	I_{th}	A	20	20	20	20	35	40	40
			I_{th}	A	18	18	18	18	32	36	36
Conventional thermal current 1 pole	Open ¹⁾		I_{th}	A	50	50	50	50	85	85	100
	Enclosed ¹⁾		I_{th}	A	45	45	45	45	80	80	90
AC-3 operation											
Rated operational current ¹⁾ 3 pole 50 - 60 Hz		220/230 V	I_e	A	7	9	12	15.5	18	25	32
		240 V	I_e	A	7	9	12	15.5	18	25	32
		380/400 V	I_e	A	7	9	12	15.5	18	25	32
		415 V	I_e	A	7	9	12	15.5	18	25	32
		440 V	I_e	A	7	9	12	15.5	18	25	32
		500 V	I_e	A	5	7	10	12.5	18	25	32
		660/690 V	I_e	A	4	5	7	9	12	15	18
		1000 V	I_e	A	–	–	–	–	–	–	–
Rated operational power		220/230 V	P	kW	2.2	2.5	3.5	4	5	7.5	10
		240 V	P	kW	2.2	3	4	4.6	5.5	8.5	11
		380/400 V	P	kW	3	4	5.5	7.5	7.5	11	15
		415 V	P	kW	4	5.5	7	8	10	14.5	19
		440 V	P	kW	4.5	5.5	7.5	8.4	10.5	15.5	20
		500 V	P	kW	3.5	4.5	7	7.5	12	17.5	23
		660/690 V	P	kW	3.5	4.5	6.5	7	11	14	17
		1000 V	P	kW	–	–	–	–	–	–	–
AC-4 operation											
Rated operational current ¹⁾ 3 pole 50 - 60 Hz		220/230 V	I_e	A	5	6	7	7	10	13	15
		240 V	I_e	A	5	6	7	7	10	13	15
		380/400 V	I_e	A	5	6	7	7	10	13	15
		415 V	I_e	A	5	6	7	7	10	13	15
		440 V	I_e	A	5	6	7	7	10	13	15
		500 V	I_e	A	4.5	5	6	6	10	13	15
		660/690 V	I_e	A	4	4.5	5	5	8	10	12
		1000 V	I_e	A	–	–	–	–	–	–	–
Rated operational power		220/230 V	P	kW	1	1.5	2	2	2.5	3.5	4
		240 V	P	kW	1.5	1.6	2.2	2.2	3	4	4.5
		380/400 V	P	kW	2.2	2.5	3	3	4.5	6	7
		415 V	P	kW	2.3	2.8	3.4	3.4	5	6.5	7.5
		440 V	P	kW	2.4	3	3.6	3.6	5.5	7	8
		500 V	P	kW	2.5	2.8	3.5	3.5	6	8	9
		660/690 V	P	kW	2.9	3.6	4.4	4.4	6.5	8.5	10
		1000 V	P	kW	–	–	–	–	–	–	–
DC voltage											
3 phase, open											
DC-1 operation		60 V	I_e	A	20	20	20	20	35	40	40
		110 V	I_e	A	20	20	20	20	35	40	40
		220 V	I_e	A	15	15	15	15	35	40	40
		440 V	I_e	A	1	1.3	1.3	1.3	2.9	2.9	2.9
DC-3 operation		60 V	I_e	A	20	20	20	20	35	35	40
		110 V	I_e	A	20	20	20	20	35	35	40
		220 V	I_e	A	1.5	1.5	1.5	1.5	10	10	25
		440 V	I_e	A	0.2	0.2	0.2	0.2	0.6	0.6	0.6
DC-5 operation		60 V	I_e	A	20	20	20	20	35	35	40
		110 V	I_e	A	20	20	20	20	35	35	40
		220 V	I_e	A	1.5	1.5	1.5	1.5	10	10	10
		440 V	I_e	A	0.2	0.2	0.2	0.2	0.6	0.6	0.6

Notes 1) At maximum permissible ambient air temperature

DILM38..C	DILM40C	DILM50C	DILM65C	DILM72C	DILM80C	DILM95C	DILM115C	DILM150C	DILM170C
45	60	80	98	98	110	130	160	190	203
43	57	71	88	88	98	125	142	180	194
40	50	65	80	80	90	110	130	160	185
36	45	58	72	72	80	100	115	144	166
100	125	162	200	200	225	275	325	400	460
90	112	145	180	180	200	250	285	360	415
38	40	50	65	72	80	95	115	150	170
38	40	50	65	72	80	95	115	150	170
38	40	50	65	72	80	95	115	150	170
38	40	50	65	72	80	95	115	150	170
38	40	50	65	72	80	95	115	150	170
38	40	50	65	72	80	95	115	150	170
25	25	32	37	37	65	80	93	100	150
—	—	—	—	—	—	—	—	—	—
11	12.5	15.5	20	22	25	30	37	48	52
11.5	13.5	17	22	25	27.5	33	40	52	57
18.5	18.5	22	30	37	37	45	55	75	90
20	24	30	39	41	48	57	70	91	100
21	25	32	41	44	51	60	75	95	105
24	28	36	47	50	58	70	85	110	120
22	23	30	35	35	63	75	90	96	140
—	—	—	—	—	—	—	—	—	—
15	18	21	25	25	40	50	55	65	65
15	18	21	25	25	40	50	55	65	65
15	18	21	25	25	40	50	55	65	65
15	18	21	25	25	40	50	55	65	65
15	18	21	25	25	40	50	55	65	65
15	18	21	25	25	40	50	55	65	65
12	14	17	20	20	27	37	45	50	50
—	—	—	—	—	—	—	—	—	—
4	5	6	7	7	12	16	17	20	20
4.5	5.5	6.5	7.5	7.5	13	17	19	22	22
7	9	10	12	12	20	26	28	33	33
7.5	9.5	11	13	13	24	30	33	39	39
8	10	12	14	14	25	32	35	41	41
9	11	13	16	16	29	36	40	47	47
10	12	14	17	17	26	35	43	48	48
—	—	—	—	—	—	—	—	—	—
40	50	60	72	72	110	110	160	160	160
40	50	50	72	72	110	110	160	160	160
40	45	45	65	65	70	70	90	90	90
2.9	2.9	2.9	2.9	2.9	4.5	4.5	4.5	4.5	4.5
40	50	60	72	72	110	110	160	160	160
40	50	50	72	72	110	110	160	160	160
25	25	25	35	35	35	35	40	40	40
0.6	0.6	0.6	0.6	0.6	1	1	1	1	1
40	50	60	72	72	110	110	160	160	160
40	50	50	72	72	110	110	160	160	160
10	25	25	35	35	35	35	40	40	40
0.6	0.6	0.6	0.6	0.6	1	1	1	1	1

1 Technical data

			DILM7..C	DILM9..C	DILM12..C DILMP20C	DILM15..C	DILM17..C	DILM25..C
Current heat loss (3 pole)								
Current heat loss at I_{th}	W		3	3	3	3	7.3	9.6
Current heat loss at I_e to AC-3/400 V	W		0.37	0.6	1.1	1.8	1.9	3.8
Impedance per pole	mΩ		2.5	2.5	2.5	2.5	2	2
Magnet systems								
Voltage tolerance								
AC operated	Pick-up	$\times U_c$	0.8 – 1.1	0.8 – 1.1	0.8 – 1.1	0.8 – 1.1	0.8 – 1.1	0.8 – 1.1
AC operated	Drop-out	$\times U_c$	0.3 – 0.6	0.3 – 0.6	0.3 – 0.6	0.3 – 0.6	0.3 – 0.6	0.3 – 0.6
DC operated ³⁾	Pick-up	$\times U_c$	0.8 – 1.1 ¹⁾	0.8 – 1.1 ¹⁾	0.8 – 1.1 ¹⁾	0.8 – 1.1 ¹⁾	0.7 – 1.2 ²⁾	0.7 – 1.2 ²⁾
DC operated ³⁾	Drop-out	$\times U_c$	0.15 – 0.6	0.15 – 0.6	0.15 – 0.6	0.15 – 0.6	0.15 – 0.6	0.15 – 0.6
Power consumption of the coil in a cold state and $1.0 \times U_c$								
50 Hz	Pick-up	VA	24	24	24	24	52	52
50 Hz	Sealing	VA	3.4	3.4	3.4	3.4	7.1	7.1
50 Hz	Sealing	W	1.2	1.2	1.2	1.2	2.1	2.1
60 Hz	Pick-up	VA	30	30	30	30	67	67
60 Hz	Sealing	VA	4.4	4.4	4.4	4.4	8.7	8.7
60 Hz	Sealing	W	1.4	1.4	1.4	1.4	2.6	2.6
50/60 Hz	Pick-up	VA	27	27	27	27	62	62
			25	25	25	25	58	58
50/60 Hz	Sealing	VA	4.2	4.2	4.2	4.2	9.1	9.1
			3.3	3.3	3.3	3.3	6.5	6.5
50/60 Hz	Sealing	W	1.4	1.4	1.4	1.4	2.5	2.5
			1.2	1.2	1.2	1.2	2	2
DC operated ³⁾	Pick-up	W	3	3	4.5	4.5	12	12
DC operated ³⁾	Sealing	W	3	3	4.5	4.5	0.5	0.5
Duty factor	% DF		100	100	100	100	100	100
Changeover times at 100 % U_c (recommended values)								
Main contacts								
AC operated								
	Closing delay	ms	15 – 21	15 – 21	15 – 21	15 – 21	16 – 22	16 – 22
	Opening delay	ms	9 – 18	9 – 18	9 – 18	9 – 18	8 – 14	8 – 14
DC operated ³⁾								
	Closing delay	ms	31	31	31	31	47	47
	Opening delay	ms	12	12	12	12	30	30
Arc ing time		ms	10	10	10	10	10	10
Permissible residual current when A1 - A2 are actuated from the electronic system (with 0 signal)	mA		–	–	–	–	–	–
Electromagnetic compatibility (EMC)								
Emitted interference	According to EN 60947-1							
Interference immunity	According to EN 60947-1							
Notes								
	1) At 24 V DC: 0.7 – 1.3 without auxiliary contact module and at ambient temperature + 40 °C							
	2) RDC 24 (U_{min} 24 V DC/ U_{max} 27 V DC)							
	RDC 60 (U_{min} 48 V DC/ U_{max} 60 V DC)							
	RDC 130 (U_{min} 110 V DC/ U_{max} 130 V DC)							
	RDC 240 (U_{min} 200 V DC/ U_{max} 240 V DC)							
	Example: $U_c=0.7 \times U_{min} \dots 1.2 \times U_{max}$							
	3) Smoothed DC, three-phase bridge rectifier or smoothed two-phase bridge rectifier							

DILM32..C DILM38..C	DILM40C	DILM50C	DILM65C DILM72C	DILM80C	DILM95C	DILM115C	DILM150C DILM170C
12.1	11.3	19	28.8	14.6	21.8	30.4	46.1
6.1	7.2	11.3	19	11.5	16.2	23.8	40.5
2	1.5	1.5	1.5	0.6	0.6	0.6	0.6
0.8 – 1.1	0.8 – 1.1	0.8 – 1.1	0.8 – 1.1	0.8 – 1.1	0.8 – 1.1	0.8 – 1.1	0.8 – 1.1
0.3 – 0.6	0.3 – 0.6	0.3 – 0.6	0.3 – 0.6	0.3 – 0.6	0.3 – 0.6	0.25 – 0.6	0.25 – 0.6
0.7 – 1.2 ²⁾	0.7 – 1.2 ²⁾	0.7 – 1.2 ²⁾	0.7 – 1.2 ²⁾	0.7 – 1.2 ²⁾	0.7 – 1.2 ²⁾	0.7 – 1.2 ²⁾	0.7 – 1.2 ²⁾
0.15 – 0.6	0.15 – 0.6	0.15 – 0.6	0.15 – 0.6	0.15 – 0.6	0.15 – 0.6	0.15 – 0.6	0.15 – 0.6
52	149	149	149	310	310	180	180
7.1	16	16	16	26	26	3.1	3.1
2.1	4.3	4.3	4.3	5.8	5.8	2.1	2.1
67	178	178	178	345	345	170	170
8.7	19	19	19	30	30	3.1	3.1
2.6	5.3	5.3	5.3	7.1	7.1	2.1	2.1
62	168	168	168	372	372	170	170
58	154	154	154	328	328	170	170
9.1	22	22	22	37.1	37.1	3.1	3.1
6.5	14	14	14	22.6	22.6	3.1	3.1
2.5	5.3	5.3	5.3	7.5	7.5	2.1	2.1
2	4.3	4.3	4.3	6.1	6.1	2.1	2.1
12	24	24	24	90	90	149	149
0.5	0.5	0.5	0.5	1.3	1.3	2.1	2.1
100	100	100	100	100	100	100	100
16 – 22	12 – 18	12 – 18	12 – 18	14 – 20	14 – 20	28 – 33	28 – 33
8 – 14	8 – 13	8 – 13	8 – 13	9 – 14	9 – 14	35 – 41	35 – 41
47	54	54	54	45	45	35	35
30	24	24	24	34	34	30	30
10	10	10	10	15	15	15	15
–	–	–	–	≤ 1	≤ 1	≤ 1	≤ 1

According to EN 60947-1

According to EN 60947-1

1.3

Contactor DILM..C

Technical data

1 Technical data

			DILAC- XHI...	DILM32C- XHI...	DILM150C- XHI...	DILM1000C- XHI...		
Auxiliary contacts								
Interlocked opposing contacts within an auxiliary contact module (to IEC 60947-5-1 Annex L)			Yes	Yes	Yes	Yes		
N/C (not late-normally closed) suitable as a mirror contact (to IEC/EN 60947-4-1, Annex F)			DILA..C DILM7..C- DILM38..C	DILM7..C- DILM38..C	DILM40C- DILM170C	DILM40C- DILM170C		
Rated impulse withstand voltage	U_{imp}	V AC	6000	6000	6000	6000		
Over-voltage category/degree of pollution			III/3	III/3	III/3	III/3		
Rated insulation voltage	U_i	V AC	690	690	690	690		
Rated operational voltage	U_e	V AC	500	500	500	500		
Safe isolation according to EN 61140								
Between coil and auxiliary contacts			V AC	440	440	440		
Between the auxiliary contacts			V AC	440	440	440		
Rated operational current								
AC-15								
220/240 V	I_e	A	4	4	6	6		
380/415 V	I_e	A	4	4	4	4		
500 V	I_e	A	1.5	1.5	1.5	1.5		
DC-13 L/R ≤ 15 ms ¹⁾								
24 V	I_e	A	10	10	10	10		
60 V	I_e	A	6	6	6	6		
110 V	I_e	A	3	3	3	3		
220 V	I_e	A	1	1	1	1		
Conventional thermal current			I_{th}	A	16	16	16	10
Control circuit reliability (at $U_e = 24$ V DC, $U_{min} = 17$ V, $I_{min} = 5.4$ mA)			Fault possibly	λ	< one failure in 100 million operations			
Component lifespan								
at $U_e = 230$ V, AC-15, 3 A			Contact	$\times 10^6$	1.3	1.3	1.3	1.3
Short-circuit rating without welding								
Max. fuse			A gG/gL	10	10	16	16	

Notes 1) Switch-on and switch-off conditions based on DC-13, time constant as specified.

Technical data

			DILM12C-XP1	DILM32C-XP1	DILM65C-XP1	DILM150C-XP1	
Parallel connector							
Terminal capacity							
Solid			mm ²	1 – 16	16	16	–
Flexible with ferrule			mm ²	1 × (0.5 – 25) 2 × (0.5 – 16)	1 × (16 – 35)	1 × (16 – 120)	–
Stranded			mm ²	1 × (0.5 – 25) 2 × (0.5 – 16)	1 × (16 – 50)	1 × (16 – 120)	1 × (35 – 300) 2 × (35 – 120)
Flat conductor	Number of layers × width × thickness	mm	6 × 9 × 0.8	–	–	–	2 × (11 × 21 × 1)
Tightening torque			Nm	4	4	14	–
Tools							
Pozidriv screwdriver			Size	2	2	–	–
Internal hexagon			SW	mm	–	5	6
Conventional thermal current							
3 pole	I_{th}	A	50	100	180	400	
4 pole	I_{th}	A	60	–	–	–	

Contactor with auxiliary contact module

DILM7..C
DILM9..C
DILM12..C
DILM15..C

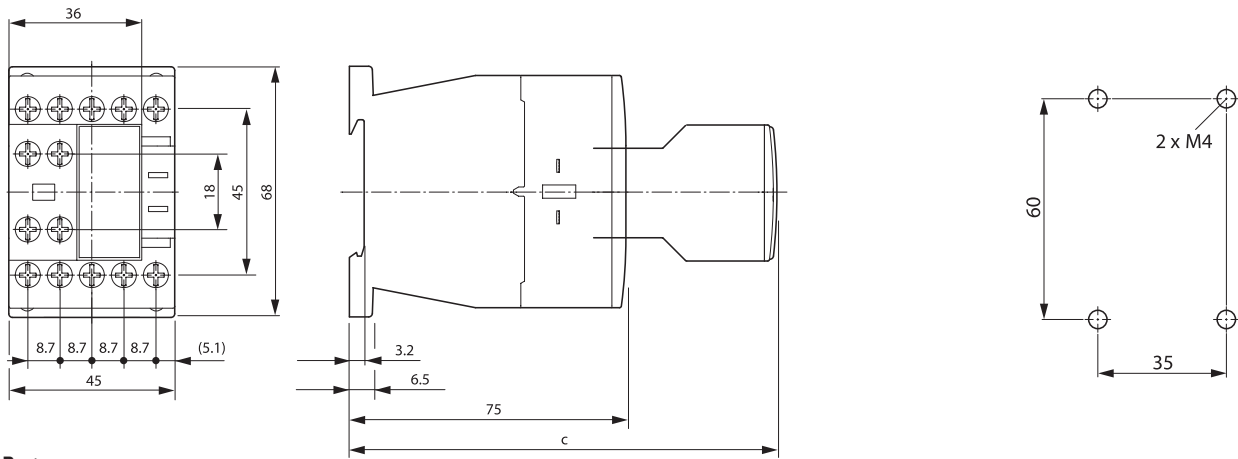

Part no.	c
DILM32C-XHI	117
DILAC-XHI	117

DILM17..C
DILM25..C
DILM32..C
DILM38..C

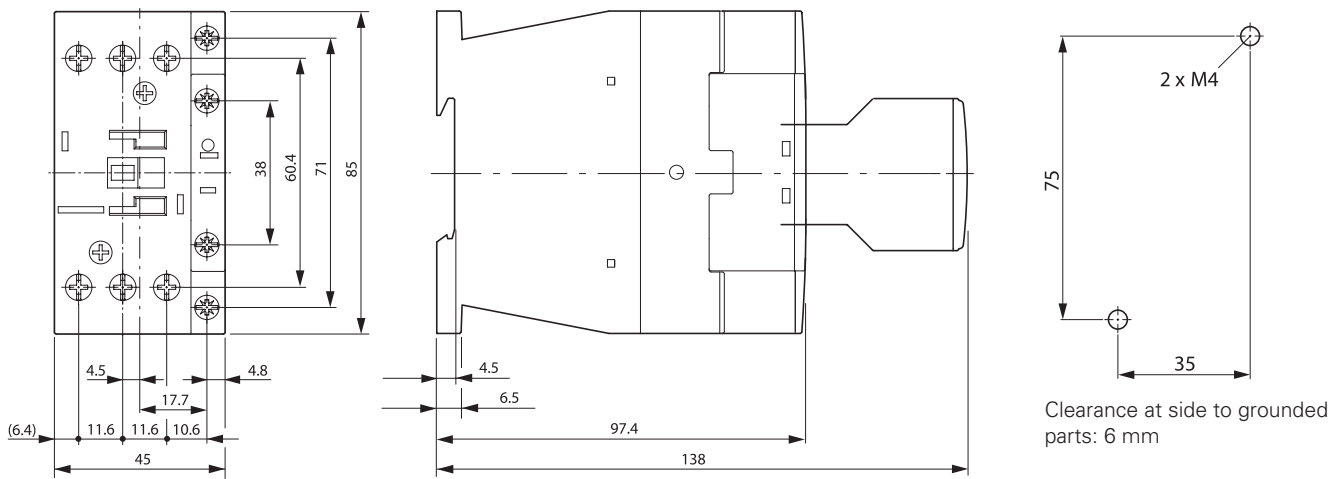

1.3

Contactor DILM.C

Dimensions

1

DILM40C
DILM50C
DILM65C
DILM72C

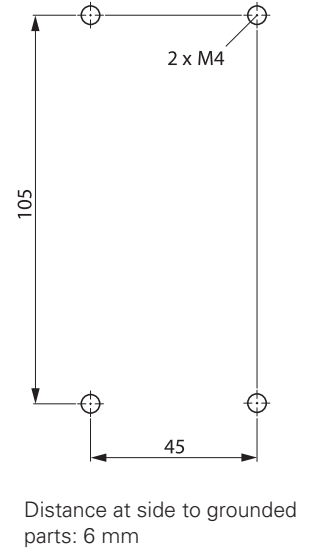
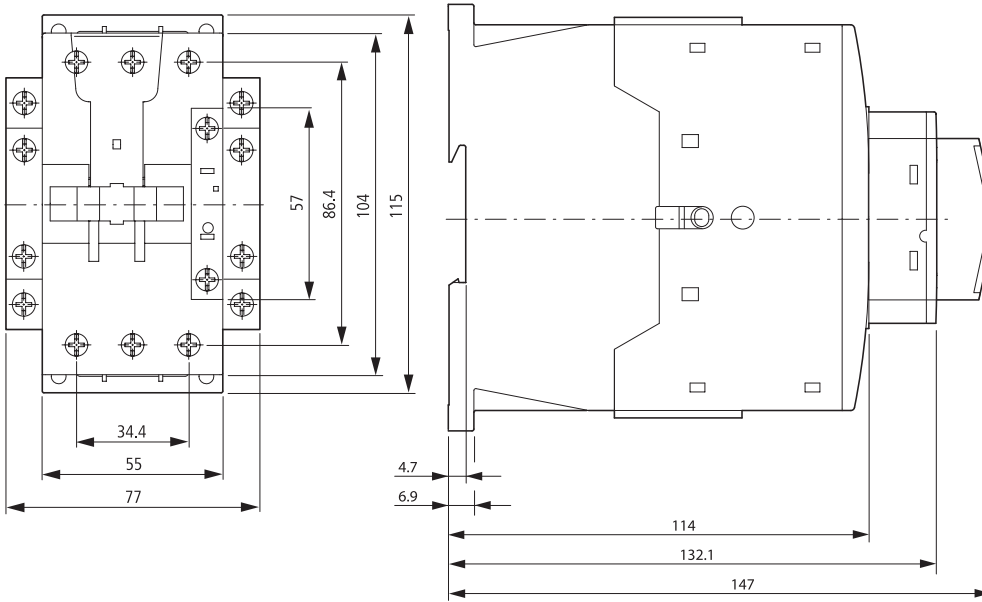

DILM80C
DILM95C
DILM115C
DILM150C
DILM170C

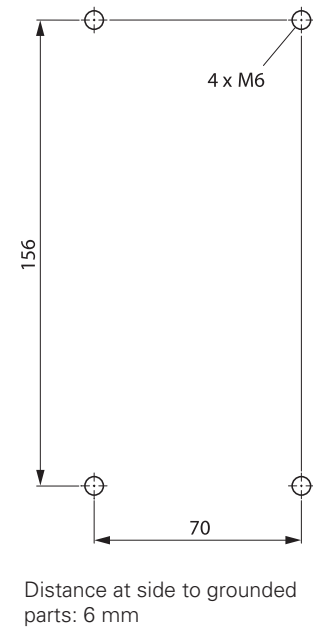
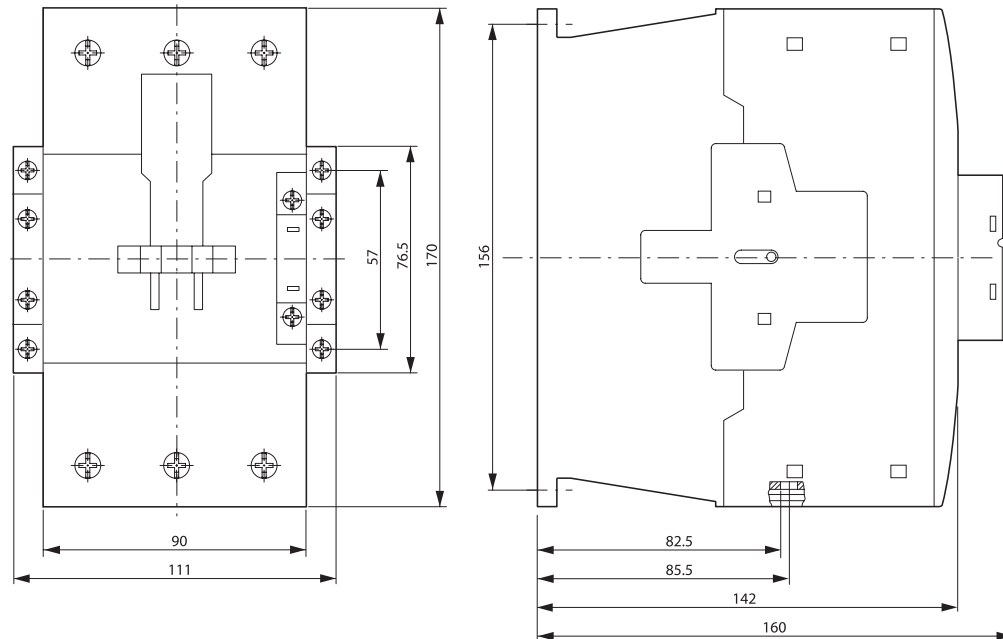

Suppressor circuits

DILM...XSP...

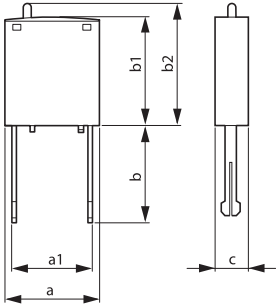

	DILM12-XSP...	DILM12-XSP...	DILM12-XSP...
a	25	25	25
a1	9.2	9.2	9.2
b	25.9	16	18.5
b1	28	28	28
b2	≈ 32	≈ 32	≈ 32
c	9	9	9

Three-phase commoning links

DILM12C-XDSB0/3
DILM12C-XDSB0/4
DILM12C-XDSB0/5

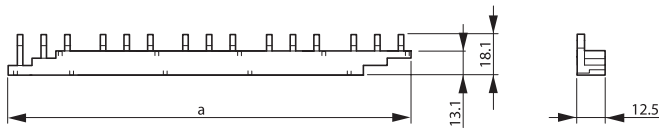

	DILM12-XDSB0/3	DILM12-XDSB0/4	DILM12-XDSB0/5
a	112	157	202

Amplifier module

ETS4-VS3

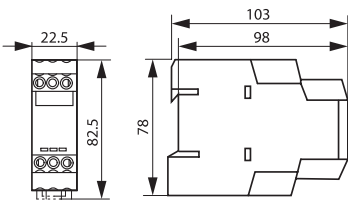

1.4

Control relays XTRD

Contents, system overview

1

Control relays XTRD



Contents

<i>Description</i>	<i>Page</i>
Control relays XTRD	
System overview	1
Basic devices XTRD	2
Auxiliary contact modules	3
Actuating voltages	3
Technical data	4
Dimensions	5

Control relays XTRD

Product Description

- Varied 4-pole contact configurations
- Conventional thermal current (Ith) of 10A
- DIN-rail or panel mount

Standards and Certifications

- IEC/EN 60947
- CE
- UL/CSA
(pending for availability)

System overview

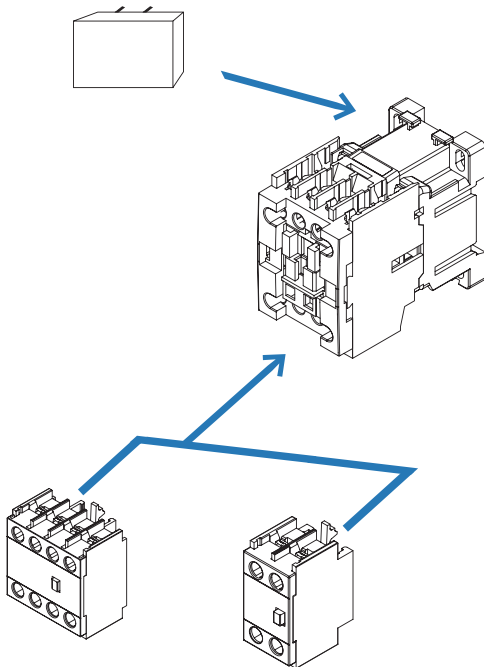

XTRD

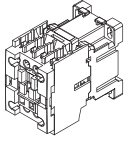

Control relays

Connection type	Contact		Rated operational current AC-15 I _e (A)		Conventional thermal current, open, 55°C I _{th} (A)	Circuit symbol	Can be combined with auxiliary contact module	AC operation	Standard package
	N/O=Normally open	N/C=Normally closed	220V	380 V				Part no.	
Screw terminals	4 N/O	-	3	1.9	10		XTCDXSAG11 XTCDXFAG..	XTRD10B40AO 152304	1 piece
Screw terminals	3 N/O	1 N/C	3	1.9	10		XTCDXSAG11 XTCDXFAG..	XTRD10B31AO 152297	1 piece
Screw terminals	2 N/O	2 N/C	3	1.9	10		XTCDXSAG11 XTCDXFAG..	XTRD10B22AO 152290	1 piece
Screw terminals	1 N/O	3 N/C	3	1.9	10		XTCDXSAG11 XTCDXFAG..	XTRD10B13AO 152283	1 piece
Screw terminals	-	4 N/C	3	1.9	10		XTCDXSAG11 XTCDXFAG..	XTRD10B04AO 152736	1 piece

Notes

With screw terminals

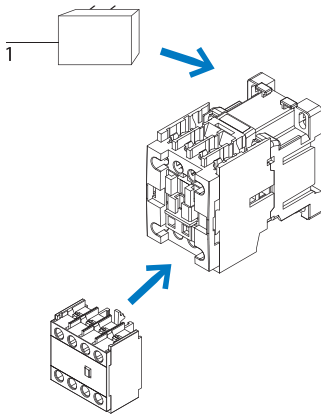

Accessories

	Page
1 Suppressor	→ 13
2 Auxiliary contact module	→ 4
Actuating voltages	→ 4

1.4

Control relays XTRD

Auxiliary contact modules, actuating voltages

1

Auxiliary contact modules

Auxiliary contact, top mounting

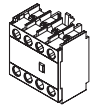

Auxiliary contact, side mounting



Connection type		Conventional thermal current open, 55°C $I_{th} = I_e$ AC-1 A	Contact N/O=Normally open N/C=Normal closed		Circuit symbol	Can be combined with control relay	Part no. Article no.	Standard package
Screw terminals	2 pole	10	2 N/O	-		XTRD10B..	XTCDXFAG20 152430	1 piece
Screw terminals	2 pole	10	1 N/O	1 N/C		XTRD10B..	XTCDXFAG11 152431	1 piece
Screw terminals	2 pole	10	-	2 N/C		XTRD10B..	XTCDXFAG02 152432	1 piece
Screw terminals	4 pole	10	4 N/O	-		XTRD10B..	XTCDXFAG40 152433	1 piece
Screw terminals	4 pole	10	3 N/O	1 N/C		XTRD10B..	XTCDXFAG31 152434	1 piece
Screw terminals	4 pole	10	2 N/O	2 N/C		XTRD10B..	XTCDXFAG22 152435	1 piece
Screw terminals	4 pole	10	1 N/O	3 N/C		XTRD10B..	XTCDXFAG13 152436	1 piece
Screw terminals	4 pole	10	-	4 N/C		XTRD10B..	XTCDXFAG04 152437	1 piece
Screw terminals	2 pole	10	1 N/O	1 N/C		XTRD10B..	XTCDXSAG11 152438	1 piece

Actuating voltages AC

Standard coil 50/60Hz	Coil Suffix	XTRD10B40.. Article no. ¹⁾	XTRD10B31.. Article no. ¹⁾	XTRD10B22.. Article no. ¹⁾	XTRD10B13.. Article no. ¹⁾	XTRD10B04.. Article no. ¹⁾
24V	B2	152306	152299	152292	152285	151738
48V	C2	152307	152300	152293	152286	151739
110V	E2	152309	152302	152295	152288	152281
220V	A0	152304	152297	152290	152283	151736
240V	H2	152310	152303	152296	152289	152282
380V	AR	152305	152298	152291	152291	151737
440V	DQ	152308	152301	152294	152287	152280

¹⁾The full part no. consists of basic type and coil suffix.

General

			XTRD	XTCDXFAG	XTCDXSAG
Standards			IEC/EN 60947, GB 14048		
Mechanical lifespan					
AC operated	Operations	x 10 ⁶	5	5	5
Maximum operating frequency					
Maximum operating frequency	Operations/h		1200	1200	1200
Climatic proofing			Damp heat, constant, to IEC 60068-2-78 Damp heat, cyclic, to IEC 60068-2-30		
Ambient temperature					
Operation		°C	-20-55	-20-55	-20-55
Storage		°C	-40-80	-40-80	-40-80
Mounting position			Have the angle of ±30° with normal vertical installation plane		

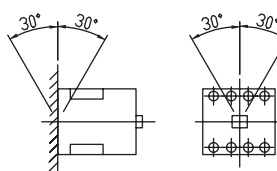

Protection type			IP20	IP20	IP20
Weight Approximate weight			kg	0.3	0.3
Terminal capacity					
Solid		mm ²	1 x (1-6)	1 x (1-6)	1 x (1-6)
			2 x (1-6)	2 x (1-6)	2 x (1-6)
Flexible with ferrule		mm ²	1 x (1-4)	1 x (1-4)	1 x (1-4)
			2 x (1-4)	2 x (1-4)	2 x (1-4)
Solid or stranded			AWG		
Terminal screw			M3.5		
Max tightening torque			Nm		
			0.8	0.8	0.8

Contacts

			XTRD	XTCDXFAG	XTCDXSAG
Rated impulse withstand voltage	U _{imp}	VAC	6000	6000	6000
Overvoltage category/degree of pollution			III/3		
Rated insulation voltage	U _i	VAC	1000	690	690
Rated operational voltage	U _e	VAC	690	600	600
Rated operational current					
AC-15					
120V	I _e	A	6	6	6
220/240V	I _e	A	3	3	3
380V	I _e	A	1.9	1.9	1.9
480V	I _e	A	1.5	1.5	1.5
500V	I _e	A	1.4	1.4	1.4
600V	I _e	A	1.2	1.2	1.2
DC-13					
125V	I _e	A	0.55	0.55	0.55
250V	I _e	A	0.27	0.27	0.27
Conventional thermal current	I _{th}	A	10	10	10
Electrical lifespan					
at U _e =230V, AC-15, 3A	Operations	x 10 ⁶	1	1	1

1.4

Control relays XTRD

Technical data

1

Magnet system

			XTRD	XTCDXFAG	XTCDXSAG
Voltage tolerance					
AC operated	Pick-up	$x U_c$	0.75-1.1	0.75-1.1	0.75-1.1
Power consumption	Pick-up	VA	70	70	70
	Sealing	VA	12	12	12
	Sealing	W	3.5	3.5	3.5
Duty factor		% DF	40	40	40

Dimensions

Control relay (with XTCDXFAG)

XTRD10B

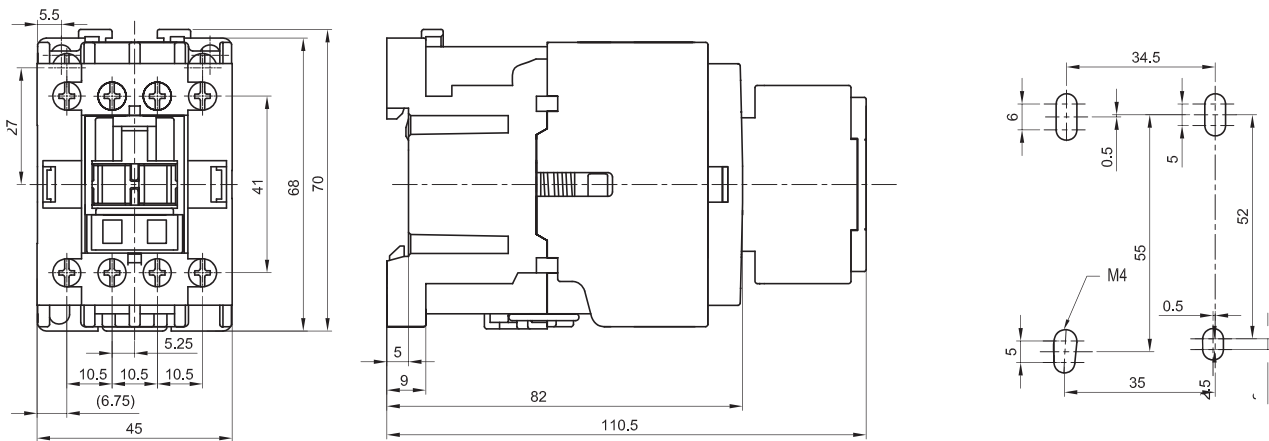

Auxiliary contact module, top mounting

XTCDXFAG(2P)

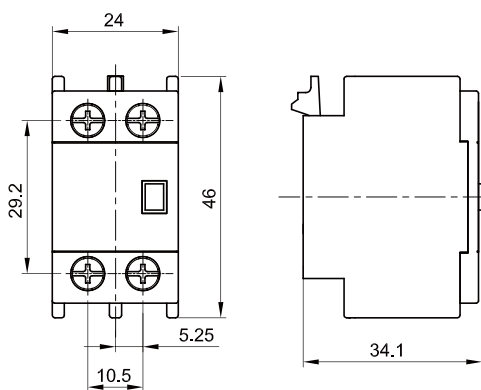

Auxiliary contact module, top mounting

XTCDXFAG(4P)

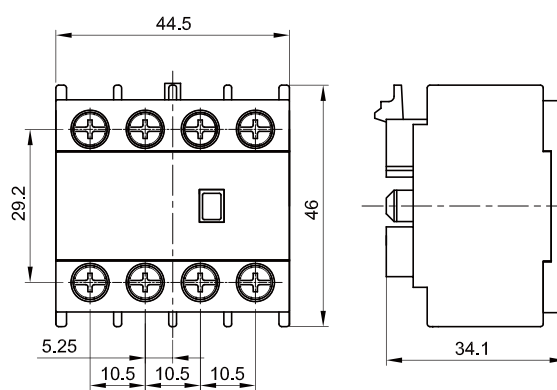

Contactors XTCD



Contents

<i>Description</i>	<i>Page</i>
Contactors XTCD	
System overview	8
Basic devices XTCD	9
Auxiliary contact modules	11
Accessories	13
Actuating voltages	14
Characteristic curves	16
Technical data	17
Dimensions	22

Contactors XTCD

Product Description

- 6 frame sizes with current ranges from 7-85A@ AC-3,400V
- Built-in auxiliary contacts on all frames
- Add-on auxiliary contacts for all frames
- Wide range of control voltages from 24-440V in dual frequency 50/60Hz
- Wide selection of accessories for all frames

Standards and Certifications

- IEC/EN 60947
- CE
- UL/CSA (pending for availability)

1.4

Contactors XTCD

System overview

1



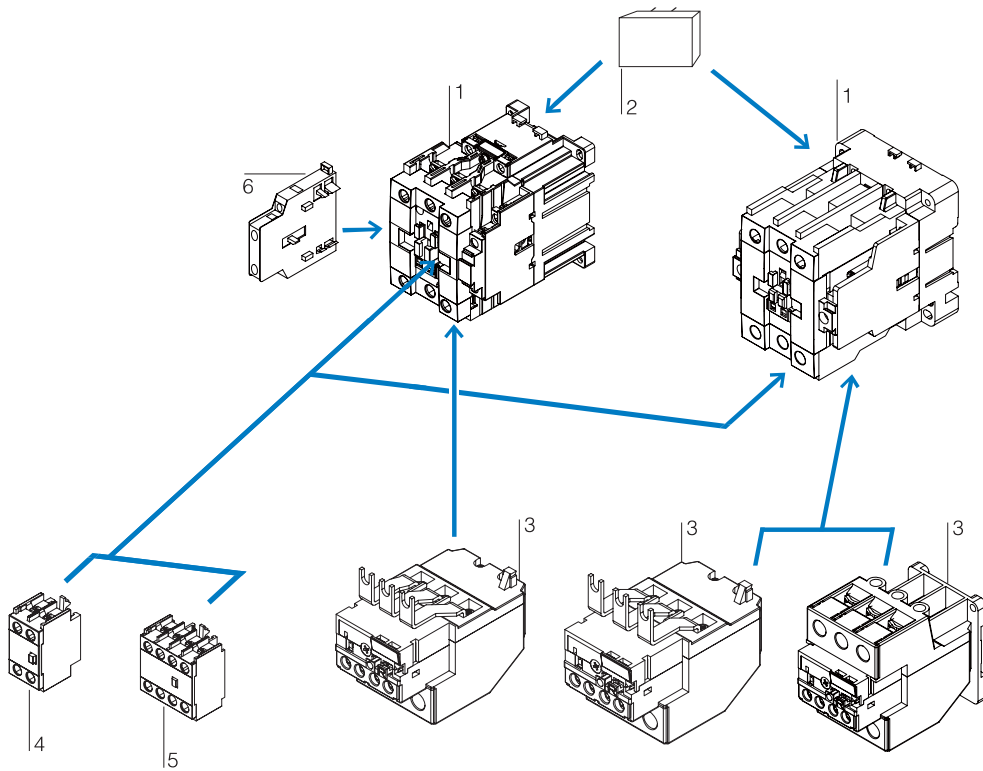
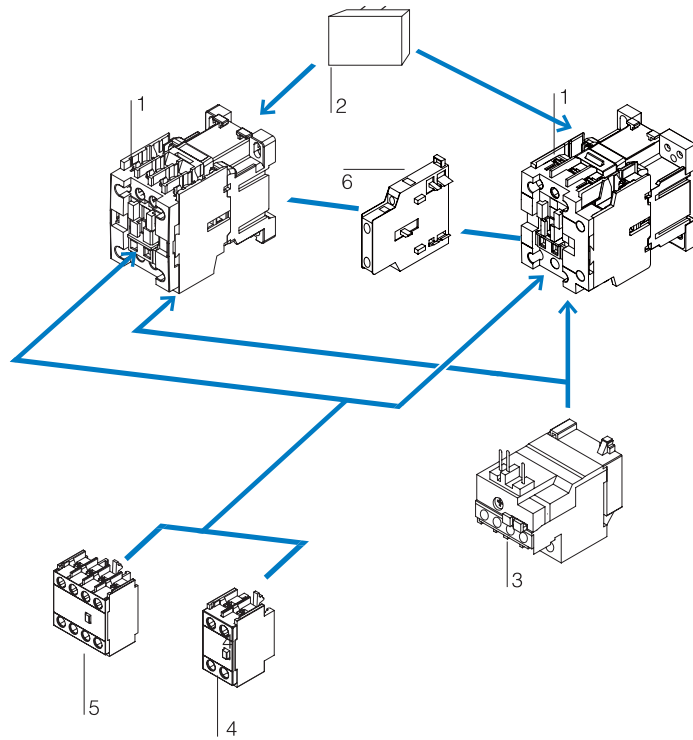





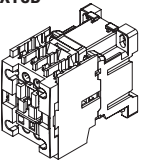

System overview

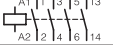
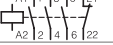
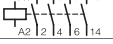
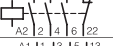
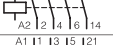

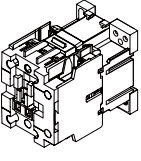
System overview

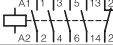
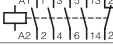
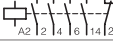
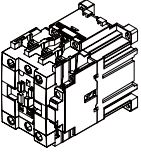
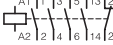
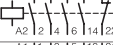
Contactor, to 45kW (AC-3/400V)	1	Thermal overload relay	3	Auxiliary contact module	5
Magnet system :		Direct mounting		4 pole, top mounting	
AC: 24V, 48V, 110V, 220V, 240V, 380V, 440V		Separate mounting			
		→ See Overload relay Catalog		→ 11	
→ 9					
Surge suppressor	2	Auxiliary contact module	4	Auxiliary contact module	6
RC suppressor		2 pole, top mounting		2 pole, side mounting	
Variastor suppressor					
		→ 11		→ 11	
→ 13					

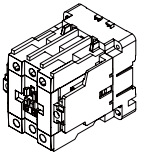
3-pole contactors

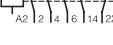
XTCD	Can be combined with auxiliary contact module	Connection type	Rated operational current AC-3 I _e (A)		Max motor rating for 3-phase motors, 50-60Hz AC-3 P kW			Conventional thermal current, open, 55 °C I _{th} = I _e AC-1(A)	Contact N/O=Normally open N/C=Normal closed	Circuit symbol	AC operation Part no. Article no. Actuating voltage 220V 50/60Hz	
			380V	400V	220V 230V	380V 400V	660V 690V					
		Screw terminals	7		2.2	3	3.5	25	1 N/O -		XTCD007B10AO 152318	
		Screw terminals	7		2.2	3	3.5	25	1 N/C		XTCD007B01AO 152311	
		Screw terminals	9		2.5	4	4.5	25	1 N/O -		XTCD009B10AO 152332	
		Screw terminals	9		2.5	4	4.5	25	1 N/C		XTCD009B01AO 152325	
		Screw terminals	12		3	5.5	5.5	25	1 N/O -		XTCD012B10AO 152346	
		Screw terminals	12		3	5.5	5.5	25	1 N/C		XTCD012B01AO 152339	
		Screw terminals	16		4	7.5	7.5	25	1 N/O -		XTCD016B10AO 152360	
		Screw terminals	16		4	7.5	7.5	25	1 N/C		XTCD016B01AO 152353	
			Screw terminals	22		5.5	11	11	32	1 N/O 1 N/C		XTCD022C11AO 152367
			Screw terminals	26		7.5	11	11	35	1 N/O 1 N/C		XTCD026C11AO 152374
		Screw terminals	32		7.5	15	18.5	50	1 N/O 1 N/C		XTCD032D11AO 152381	
		Screw terminals	38		11	18.5	22	60	1 N/O 1 N/C		XTCD038E11AO 152388	
		Screw terminals	40		11	20	22	60	1 N/O 1 N/C		XTCD040F11AO 152395	
		Screw terminals	55		15	25	30	70	2 N/O 2 N/C		XTCD055G22AO 152402	
		Screw terminals	64		18.5	30	37	80	2 N/O 2 N/C		XTCD065G22AO 152409	
		Screw terminals	72		22	37	45	100	2 N/O 2 N/C		XTCD072G22AO 152416	
		Screw terminals	85		25	45	45	135	2 N/O 2 N/C		XTCD085G22AO 152423	

Standard package: 1piece

Notes

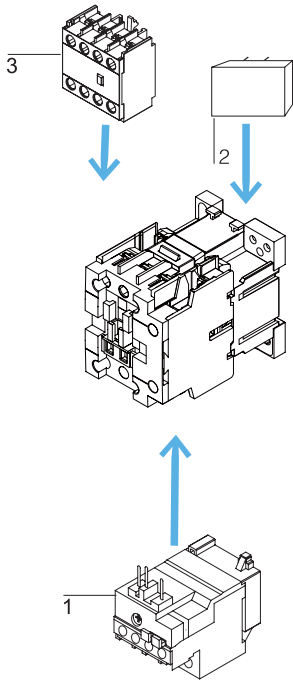

Accessories

Page

1 Overload relay	→ See Overload relay Catalog
2 Suppressor	→ 13
3 Auxiliary contact module	→ 1
Actuating voltages	→ 14
Other accessories	→ 13





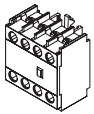

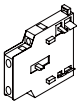

Auxiliary contact modules

Auxiliary contact, top mounting



Auxiliary contact, side mounting



Can be combined with control relay	Connection type	Conventional thermal current, open, 55 °C $I_{th} = I_e$ AC-1(A)	Contact N/O=Normally open N/C=Normal closed	Circuit symbol	Part no. Article no.	Standard package		
XTCD007	Screw terminals	2 pole	10	2 N/O	-		XTCDXFAG20 152430	1 piece
XTCD009	Screw terminals	2 pole	10	1 N/O	1 N/C		XTCDXFAG11 152431	1 piece
XTCD012	Screw terminals	2 pole	10	-	2 N/C		XTCDXFAG02 152432	1 piece
XTCD016	Screw terminals	4 pole	10	4 N/O	-		XTCDXFAG40 152433	1 piece
XTCD022	Screw terminals	4 pole	10	3 N/O	1 N/C		XTCDXFAG31 152434	1 piece
XTCD026	Screw terminals	4 pole	10	2 N/O	2 N/C		XTCDXFAG22 152435	1 piece
XTCD032	Screw terminals	4 pole	10	1 N/O	3 N/C		XTCDXFAG13 152436	1 piece
XTCD038	Screw terminals	4 pole	10	-	4 N/C		XTCDXFAG04 152437	1 piece
XTCD040	Screw terminals	2 pole	10	1 N/O	1 N/C		XTCDXSAG11 152438	1 piece

Auxiliary contact modules

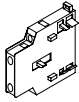

XTCDXSAG11

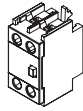

XTCDXFAG20
XTCDXFAG11
XTCDXFAG02

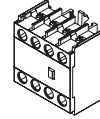

XTCDXFAG40
XTCDXFAG31
XTCDXFAG22
XTCDXFAG13
XTCDXFAG04





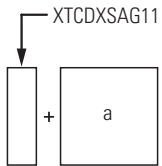







XTCD007	1x	-	-
XTCD009	-	1x	-
XTCD012	-	-	-
XTCD016	-	-	1x
XTCD022	-	-	-
XTCD026	-	-	-
XTCD032	-	-	-
XTCD038	-	-	-
XTCD040	-	-	-
<hr/>			
XTCD055	-	1x	-
XTCD065	-	-	1x
XTCD072	-	-	-
XTCD085	-	-	-

Auxiliary contact, side mounting



a XTCD007 - XTCD040

Surge suppressors

For use with	Voltage V	Circuit symbol	Part no. Article no.	Standard package	Note	
RC suppressors 	24		XTCDXRSGB2 152441	1 piece	Note release delay	
	48		XTCDXRSGC2 152442	1 piece	Note release delay	
	110		XTCDXRSGE2 152443	1 piece	Note release delay	
	220-240		XTCDXRSGH2 152444	1 piece	Note release delay	
	440		XTCDXRSGDQ 152445	1 piece	Note release delay	
	Varistor suppressors 	24		XTCDXVSGB2 152446	1 piece	Note release delay
		48		XTCDXVSGC2 152447	1 piece	Note release delay
		110		XTCDXVSGE2 152448	1 piece	Note release delay
		220-240		XTCDXVSGH2 152449	1 piece	Note release delay
		440		XTCDXVSGDQ 152450	1 piece	Note release delay

Mechanical interlocks

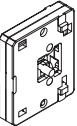
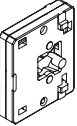
For use with	Part no. Article no.	Standard package
	XTCDXMLD 152439	1 piece
	XTCD007	
	XTCD009	
	XTCD012	
	XTCD016	
	XTCDXMLG 152440	1 piece
	XTCD038	
	XTCD040	
	XTCD055	
	XTCD065	
	XTCD072	

Spare coils

For use with	Part no. Article no.	Standard package	
Actuating voltage 220V 50/60Hz			
XTCD007 XTCD009 XTCD012 XTCD016 XTCD022 XTCD026 XTCD032	XTCDRENCOILDAO 152451	1 piece	
	XTCD038	XTCDRENCOILEAO 152458	1 piece
		XTCDRENCOILFAO 152465	1 piece
	XTCD040 XTCD055 XTCD065 XTCD072 XTCD085	XTCDRENCOILGAO 152472	1 piece

Actuating voltages AC

Standard coil 50/60Hz	Coil Suffix	XTCD007B10.. Article no. ¹⁾	XTCD007B01.. Article no. ¹⁾	XTCD009B10.. Article no. ¹⁾	XTCD009B01.. Article no. ¹⁾	XTCD012B10.. Article no. ¹⁾	XTCD012B01.. Article no. ¹⁾	XTCD016B10.. Article no. ¹⁾
24V	B2	152320	152313	152334	152327	152348	152341	152362
48V	C2	152321	152314	152335	152328	152349	152342	152363
110V	E2	152323	152316	152337	152330	152351	152344	152365
220V	AO	152318	152311	152332	152325	152346	152339	152360
240V	H2	152324	152317	152338	152331	152352	152345	152366
380V	AR	152319	152312	152333	152326	152347	152340	152361
440V	DQ	152322	152315	152336	152329	152350	152343	152364

Standard coil 50/60Hz	Coil Suffix	XTCD016B01.. Article no. ¹⁾	XTCD022C11.. Article no. ¹⁾	XTCD026C11.. Article no. ¹⁾	XTCD032D11.. Article no. ¹⁾	XTCD038E11.. Article no. ¹⁾	XTCD040F11.. Article no. ¹⁾	XTCD052G22.. Article no. ¹⁾
24V	B2	152355	152369	152376	152383	152390	152397	152404
48V	C2	152356	152370	152377	152384	152391	152398	152405
110V	E2	152358	152372	152379	152386	152393	152400	152407
220V	AO	152353	152367	152374	152381	152388	152395	152402
240V	H2	152359	152373	152380	152387	152394	152401	152408
380V	AR	152354	152368	152375	152382	152389	152396	152403
440V	DQ	152357	152371	152378	152385	152392	152399	152406

Standard coil 50/60Hz	Coil Suffix	XTCD065G22.. Article no. ¹⁾	XTCD072G22.. Article no. ¹⁾	XTCD085G22.. Article no. ¹⁾
24V	B2	152411	152418	152425
48V	C2	152412	152419	152426
110V	E2	152414	152421	152428
220V	AO	152409	152416	152423
240V	H2	152415	152422	152429
380V	AR	152410	152417	152424
440V	DQ	152413	152420	152427

¹⁾The full part no. consists of basic type and coil suffix.

1.4

Contactors XTCD

Spare coils

1

Spare coils AC

Standard coil 50/60Hz	Coil Suffix	XTCDRENCOILD.. Article no. ¹⁾	XTCDRENCOILE.. Article no. ¹⁾	XTCDRENCOILF.. Article no. ¹⁾	XTCDRENCOILG.. Article no. ¹⁾
24V	B2	152453	152460	152467	152474
48V	C2	152454	152461	152468	152475
110V	E2	152456	152463	152470	152477
220V	A0	152451	152458	152465	152472
240V	H2	152457	152464	152471	152478
380V	AR	152452	152459	152466	152473
440V	DQ	152455	152462	152469	152476

¹⁾The full part no. consists of basic type and coil suffix.

Normal switching duty

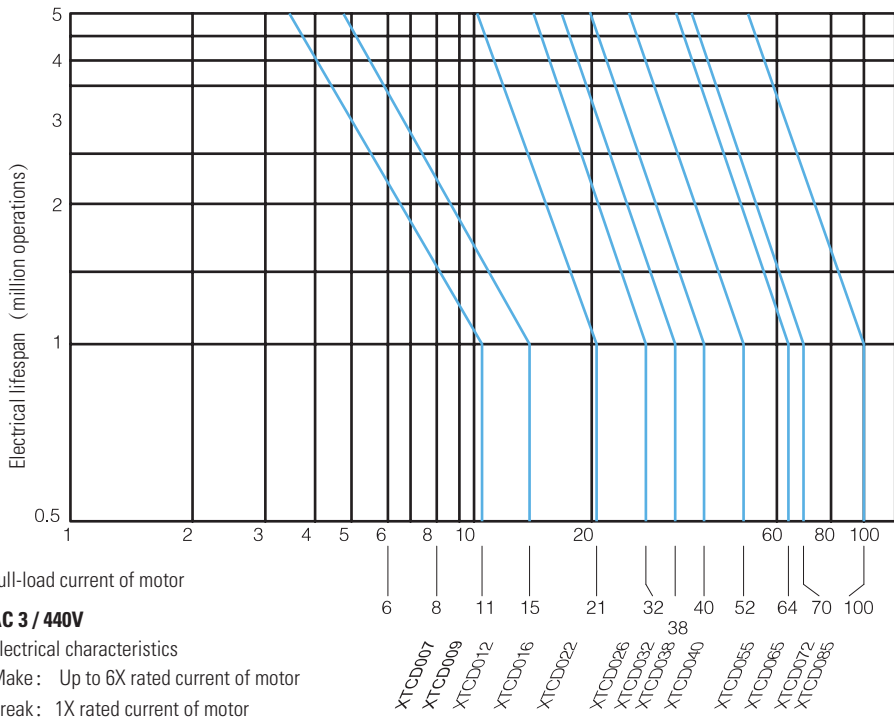
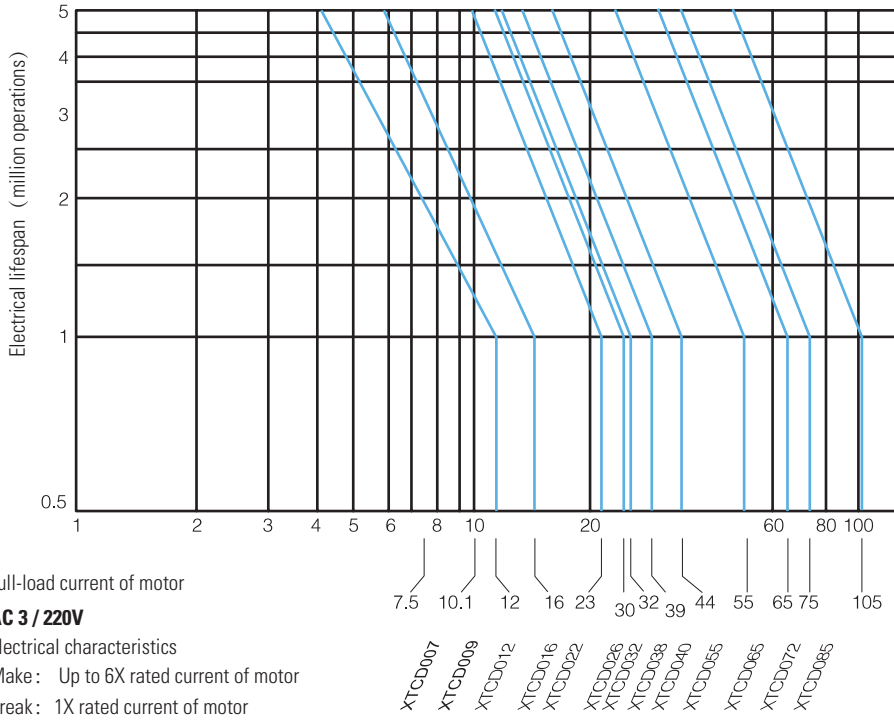

General

XT Basic device			CD007	CD009	CD012	CD016	CD022
Standards			IEC/EN 60947, GB 14048				
Lifespan, mechanical							
AC operated	Operations	x 10 ⁶	5	5	5	5	5
Operating frequency, mechanical							
AC operated	Operations/h		1200	1200	1200	1200	1200
Climatic Proofing			Damp heat, constant, to IEC60068-2-78 Damp heat, cyclic, to IEC60068-2-30				
Ambient temperature							
Operation		°C	-20-55	-20-55	-20-55	-20-55	-20-55
Storage		°C	-40-80	-40-80	-40-80	-40-80	-40-80
Mounting position			Have the angle of ± 30° with normal vertical installation plane				
Protection type			IP20	IP20	IP20	IP20	IP20
Weight			kg	0.3	0.3	0.3	0.4
Terminal capacity of main cable							
Solid		mm ²	1 x (1.5-6) 2 x (1.5-6)	1 x (1.5-6) 2 x (1.5-6)	1 x (1.5-6) 2 x (1.5-6)	1 x (1.5-6) 2 x (1.5-6)	1 x (2.5-10) 2 x (2.5-10)
Flexible with ferrule		mm ²	1 x (1.5-4) 2 x (1.5-4)	1 x (1.5-4) 2 x (1.5-4)	1 x (1.5-4) 2 x (1.5-4)	1 x (1.5-4) 2 x (1.5-4)	1 x (2.5-6) 2 x (2.5-6)
Solid/stranded		AWG					
Terminal capacity of control circuit cable		mm ²	1	1	1	1	1
Main cable connection screws / bolts			M3.5	M3.5	M3.5	M3.5	M4
Tightening torque			Nm	0.8	0.8	0.8	1.2
Control circuit cable connection screws / bolts			M3.5	M3.5	M3.5	M3.5	M3.5
Tightening torque			Nm	0.8	0.8	0.8	0.8
Main contacts							
Rated impulse withstand voltage		U _{imp} V AC	6000	6000	6000	6000	6000
Overvoltage category / pollution degree			I/3	III/3	III/3	III/3	III/3
Rated insulation voltage			U _i	1000	1000	1000	1000
Rated operational voltage			U _e	690	690	690	690
Making capacity (cosφ to IEC/EN60947)		A to 690 V	60	60	70	100	140
Breaking capacity (cos φ to IEC/EN60947)		A					
220V/230V		A	92	92	96	128	184
380V/400V		A	88	88	96	128	176
500V		A	64	64	72	104	152
660V/690V		A	48	48	56	80	112
Electrical lifespan							
I _e AC-3 400V		x 10 ⁶ Op.	1	1	1	1	1
Maximum operating frequency							
I _e AC-3 400V		Op./h	1200	1200	1200	1200	1200

CD026	CD032	CD038	CD040	CD055	CD065	CD072	CD085
IEC/EN 60947, GB 14048							
5	5	5	5	5	5	5	5
1200	1200	1200	1200	1200	1200	1200	1200
Damp heat, constant, to IEC60068-2-78							
Damp heat, cyclic, to IEC60068-2-30							
-20-55	-20-55	-20-55	-20-55	-20-55	-20-55	-20-55	-20-55
-40-80	-40-80	-40-80	-40-80	-40-80	-40-80	-40-80	-40-80

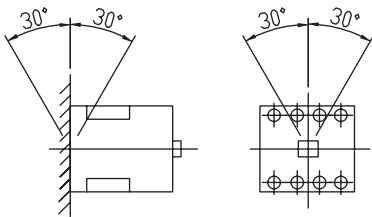

IP20	IP20	IP20	IP20	IP20	IP20	IP00	IP00
0.4	0.7	0.7	0.9	1.3	1.3	1.3	1.3
1 x (2.5-10) 2 x (2.5-10)	1 x (2.5-16) 2 x (2.5-16)	1 x (2.5-16) 2 x (2.5-16)	1 x (4-16) 2 x (4-16)	1 x (10-50) 2 x (10-50)	1 x (10-50) 2 x (10-50)	1 x (10-50) 2 x (10-50)	1 x (10-50) 2 x (10-50)
1 x (2.5-6) 2 x (2.5-6)	1 x (2.5-10) 2 x (2.5-10)	1 x (2.5-10) 2 x (2.5-10)	1 x (2.5-10) 2 x (2.5-10)	1 x (6-35) 2 x (6-35)	1 x (6-35) 2 x (6-35)	1 x (6-35) 2 x (6-35)	1 x (6-35) 2 x (6-35)
1	1	1	1	1	1	1	1
M4	M5	M5	M5	M6	M6	M6	M6
1.2	2.0	2.0	2.0	3.0	3.0	3.0	3.0
M3.5	M3.5	M3.5	M3.5	M3.5	M3.5	M3.5	M.5
0.8	0.8	0.8	0.8	0.8	0.8	0.8	0.8
6000	6000	6000	6000	6000	6000	6000	6000
III/3	III/3	I/3	III/3	III/3	III/3	III/3	III/3
1000	1000	1000	1000	1000	1000	1000	1000
690	690	690	690	690	690	690	690
140	220	242	260	350	450	600	650
216	280	312	352	440	520	600	680
208	256	304	320	440	512	576	680
152	240	264	280	360	440	520	640
112	176	176	208	280	360	480	520
1	1	1	1	1	1	1	1
1200	1200	1200	1200	1200	1200	1200	1200

1.4

Contactors XTCD

Technical data

1

AC voltage

XT Basic device				CD007	CD009	CD012	CD016	CD022
AC-1 operation								
Conventional thermal current, open, 50-60 Hz, 3 pole	at 40 °C	I_{th}	A	25	25	25	25	35
	at 50 °C	I_{th}	A	25	25	25	25	32
	at 55 °C	I_{th}	A	25	25	25	25	32
AC-3 operation								
Rated operational current, open, 50-60 Hz, 3 pole	220/230V	I_e	A	7	9	12	16	23
	380/400V	I_e	A	7	9	12	16	22
	415V	I_e	A	7	9	11	15	21
	440V	I_e	A	7	9	11	15	21
	500V	I_e	A	7	8	9	13	19
	660/690V	I_e	A	4	5	7	10	14
Rated operational power	220/230V	P	kW	2.2	2.5	3	4	5.5
	380/400V	P	kW	3	4	5.5	7.5	11
	415V	P	kW	3	4	5.5	7.5	11
	440V	P	kW	3	4	5.5	7.5	11
	500V	P	kW	3	4	5.5	7.5	11
	660/690V	P	kW	3.5	4.5	5.5	7.5	11
Magnet systems								
Voltage tolerance								
AC operated	Pick-up		$x U_c$	0.75-1.1	0.75-1.1	0.75-1.1	0.75-1.1	0.75-1.1
Power consumption of coil in a cold state and 1.0 xU_c								
	Pick-up		VA	70	70	70	70	70
	Sealing		VA	12	12	12	12	12
	Sealing		W	3.5	3.5	3.5	3.5	3.5
Duty factor			%DF	40	40	40	40	40

CD026	CD032	CD038	CD03840	CD055	CD065	CD072	CD085
40	60	60	60	70	80	100	135
35	50	60	60	70	80	100	135
35	50	60	60	70	80	100	135
27	32	39	42	55	65	75	85
26	32	38	40	55	64	72	85
21	32	38	40	52	64	72	85
21	32	38	40	52	64	70	85
19	30	33	35	45	55	65	80
14	22	24	26	35	45	60	65
7.5	7.5	11	11	15	18.5	22	25
11	15	18.5	20	25	30	37	45
11	15	22	22	25	33	40	45
11	15	22	22	30	37	40	51
11	18.5	22	22	30	37	45	55
11	18.5	22	22	30	37	45	55
0.75-1.1	0.75-1.1	0.75-1.1	0.75-1.1	0.75-1.1	0.75-1.1	0.75-1.1	0.75-1.1
70	70	215	215	280	280	280	280
12	12	27	27	32	32	32	32
3.5	3.5	6	6	6	6	6	6
40	40	40	40	40	40	40	40

1.4

Contactors XTCD

Technical data of auxiliary contact modules

1

Auxiliary contact

			XTCDXFAG	XTCDXSAG
Rated impulse withstand voltage	U_{imp}	VAC	6000	6000
Overvoltage category/degree of pollution			III/3	III/3
Rated insulation voltage	U_i	VAC	690	690
Rated operational voltage	U_e	VAC	600	600
Rated operational current				
AC-15				
120V	I_e	A	6	6
220/240V	I_e	A	3	3
380V	I_e	A	1.9	1.9
480V	I_e	A	1.5	1.5
500V	I_e	A	1.4	1.4
600V	I_e	A	1.2	1.2
DC-13				
125V	I_e	A	0.55	0.55
250V	I_e	A	0.27	0.27
Conventional thermal current	I_{th}	A	10	10
Electrical lifespan				
at $U_e=230V$, AC-15, 3A	Operations	$\times 10^6$	1	1

Dimensions

Contactor (with XTCDXFAG)
XTCD007B
XTCD009B
XTCD012B
XTCD016B

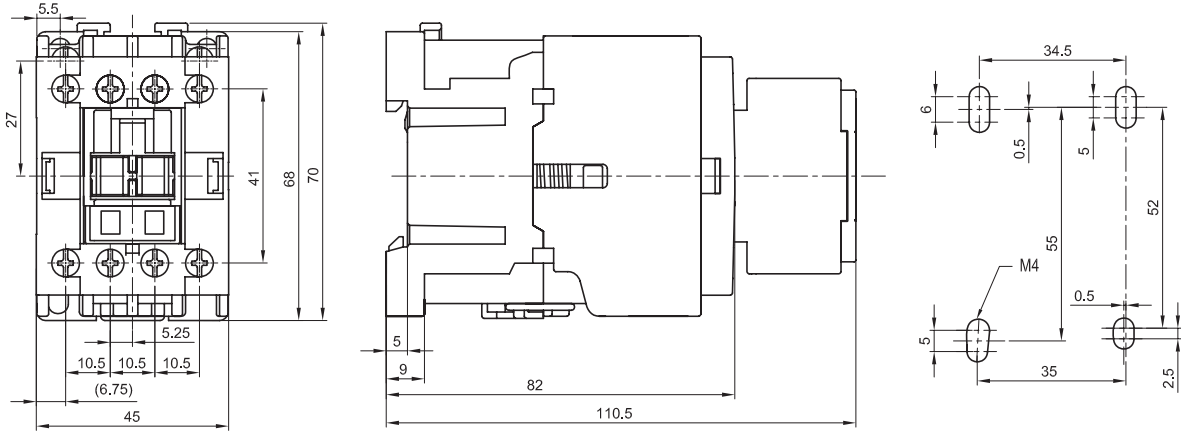

XTCD022C
XTCD026C

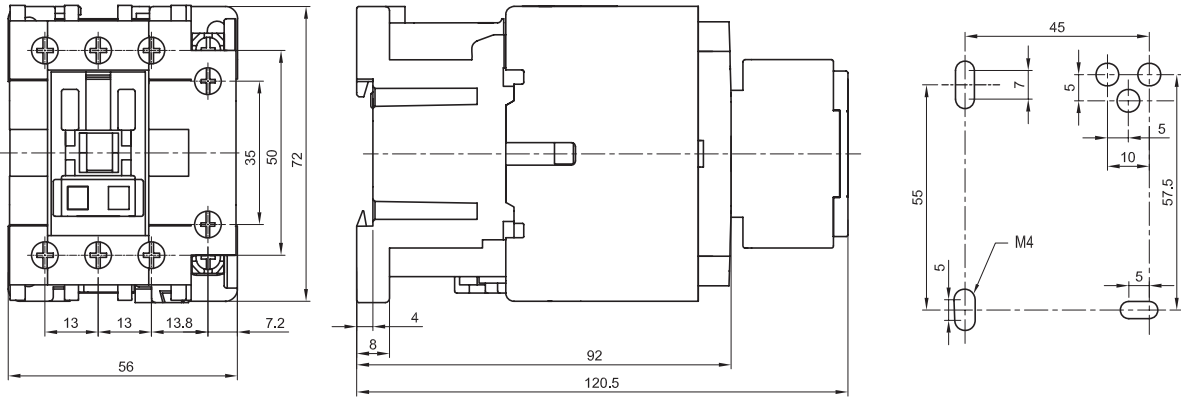

XTCD032D

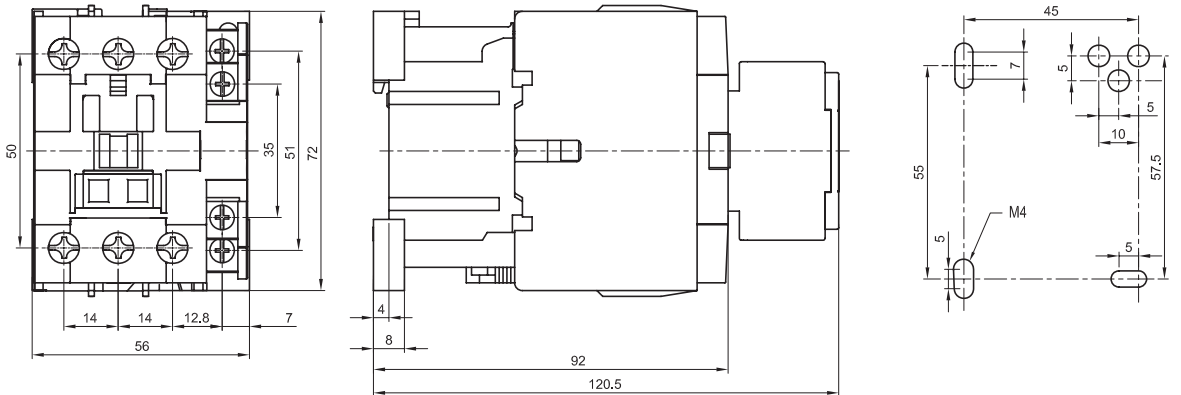

1.4

Contactors XTCD Dimensions

1

Dimensions

XTCD038E

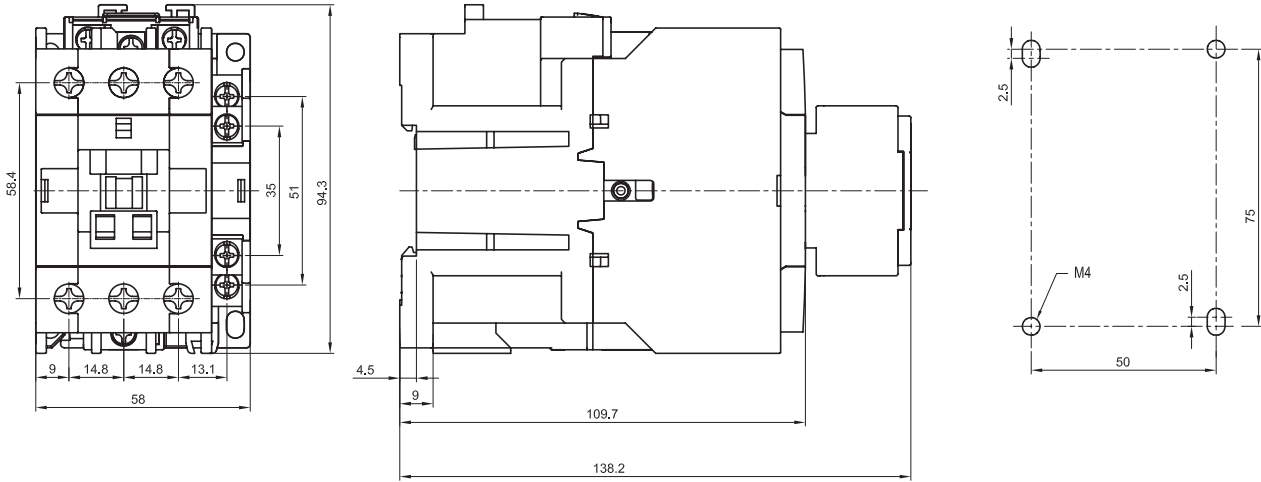

XTCD040F

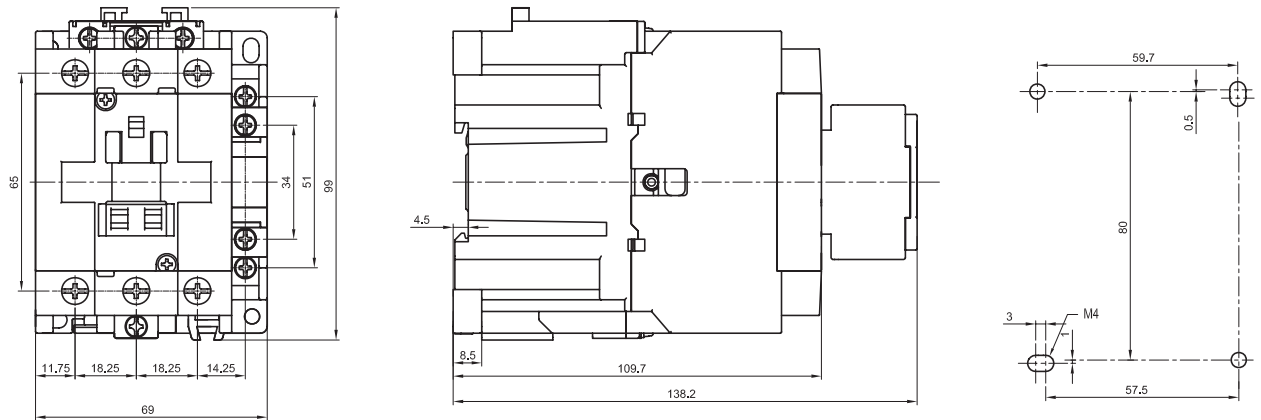

XTCD055G XTCD065G

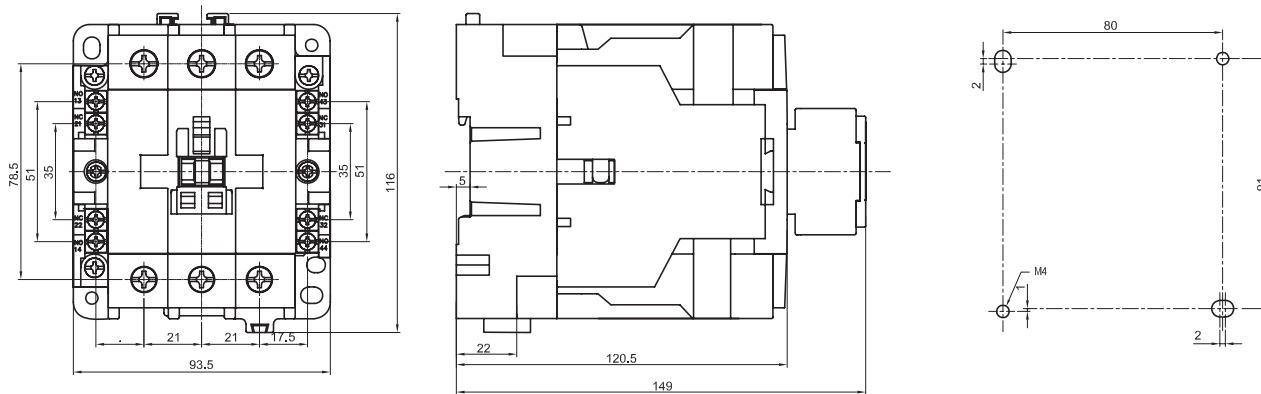

Dimensions

XTCD072G
XTCD085G

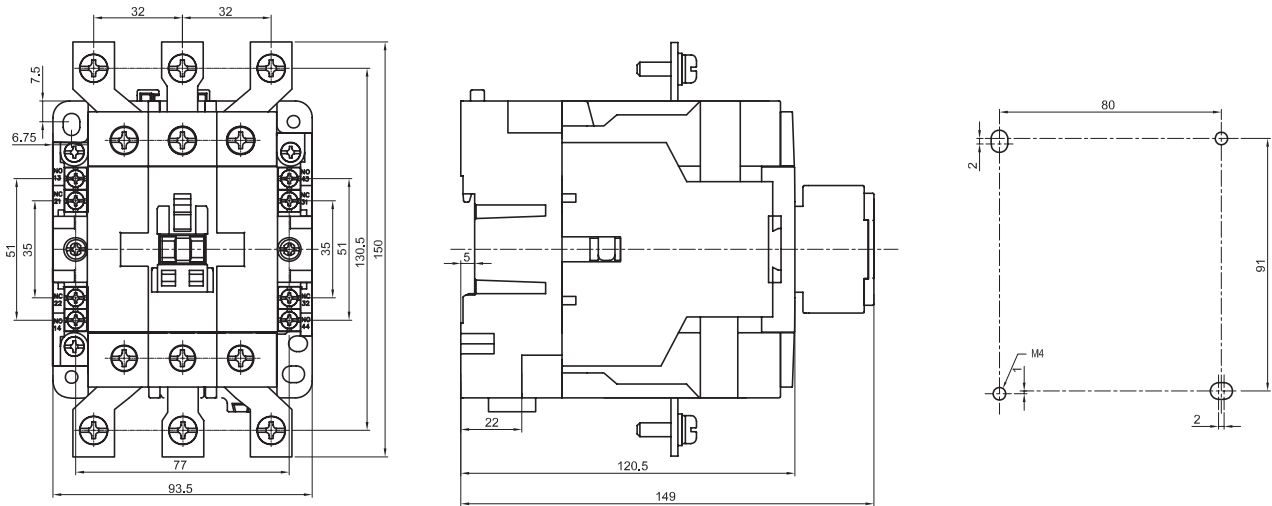

Auxiliary contact module, top mounting
XTCDXFAG(2P)

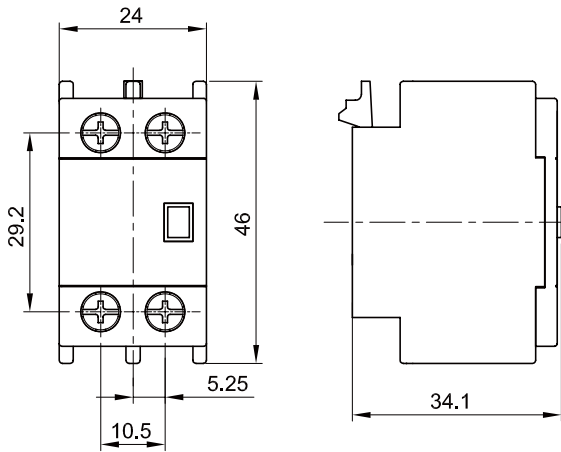

Auxiliary contact module, top mounting
XTCDXFAG(4P)

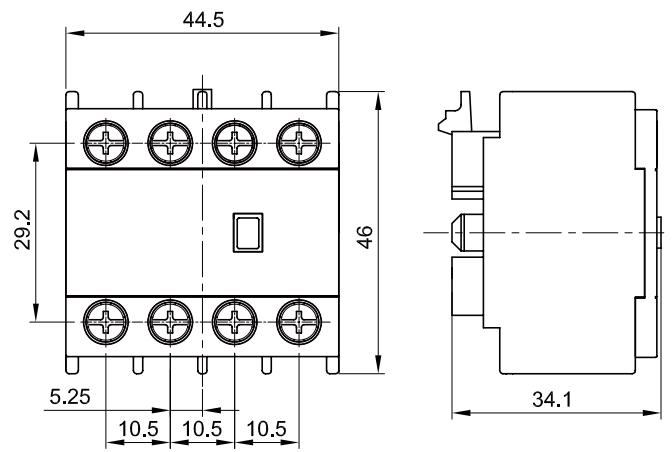

Auxiliary contact module, side mounting
XTCDXSAG

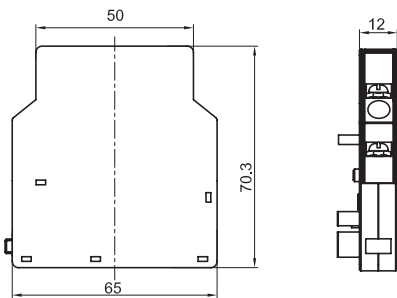

1.4

Contactors XTCD

Dimensions

1

Dimensions

Mechanical interlock XTCDXMLD

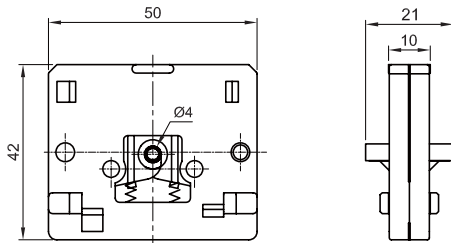

Mechanical interlock XTCDXMLG

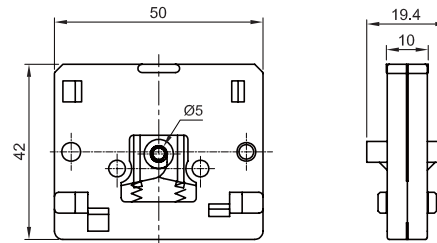

Suppressor XTCDXVSG XTCDXVRG

