

High Accuracy Standard Temperature Controller

TK Series

USER MANUAL

CE cULus



TK Series

Thank you for choosing our Autonics products.

Please read the following safety considerations before use.

Preface

Thank you for purchasing an Autonics product.





Please familiarize yourself with the information contained in the Safety Precautions section before using this product.

This user manual contains information about the product and its proper use, and should be kept in a place where it will be easy to access.

User Manual Guide

- Please familiarize yourself with the information in this manual before using the product.
- This manual provides detailed information on the product's features. It does not offer any guarantee concerning matters beyond the scope of this manual.
- This manual may not be edited or reproduced in either part or whole without permission.
- A user manual is not provided as part of the product package.
Visit our web site (www.autonics.com) to download a copy.
- The manual's content may vary depending on changes to the product's software and other unforeseen developments within Autonics, and is subject to change without prior notice.
Upgrade notice is provided through out homepage.
- We contrived to describe this manual more easily and correctly. However, if there are any corrections or questions, please notify us these on our homepage.

User Manual Symbols

Symbol	Description
 Note	Supplementary information for a particular feature.
 Warning	Failure to follow instructions can result in serious injury or death.
 Caution	Failure to follow instructions can lead to a minor injury or product damage.
 Ex.	An example of the concerned feature's use.
※1	Annotation mark.

Safety Considerations

- Following these safety precautions will ensure the safe and proper use of the product and help prevent accidents, as well as minimizing possible hazards.
- Safety precautions are categorized as Warnings and Cautions, as defined below:

 Warning	Warning	Failure to follow the instructions may lead to a serious injury or accident.
--	----------------	--

 Caution	Caution	Failure to follow the instructions may lead to a minor injury or accident.
--	----------------	--

Warning

- Fail-safe device must be installed when using the unit with machinery that may cause serious injury or substantial economic loss. (e.g. nuclear power control, medical equipment, ships, vehicles, railways, aircraft, combustion apparatus, safety equipment, crime/disaster prevention devices, etc.)
Failure to follow this instruction may result in fire, personal injury, or economic loss.
- Install on a device panel to use.
Failure to follow this instruction may result in electric shock or fire.
- Do not connect, repair, or inspect the unit while connected to a power source.
Failure to follow this instruction may result in electric shock or fire.
- Check 'Connections' before wiring.
Failure to follow this instruction may result in fire.
- Do not disassemble or modify the unit.
Failure to follow this instruction may result in electric shock or fire.

Caution

- When connecting the power input and relay output, use AWG 20(0.50mm²) cable or over and tighten the terminal screw with a tightening torque of 0.74 to 0.90N·m.
When connecting the sensor input and communication cable without dedicated cable, use AWG 28 to 16 cable and tighten the terminal screw with a tightening torque of 0.74 to 0.90N·m.
Failure to follow this instruction may result in fire or malfunction due to contact failure.
- Use the unit within the rated specifications.
Failure to follow this instruction may result in fire or product damage.
- Use dry cloth to clean the unit, and do not use water or organic solvent.
Failure to follow this instruction may result in electric shock or fire.
- Do not use the unit in the place where flammable/explosive/corrosive gas, humidity, direct sunlight, radiant heat, vibration, impact, or salinity may be present.
Failure to follow this instruction may result in fire or explosion.
- Keep metal chip, dust, and wire residue from flowing into the unit.
Failure to follow this instruction may result in fire or product damage.

Cautions during Use

- Follow instructions in 'Cautions during Use'. Otherwise, It may cause unexpected accidents.
- Check the polarity of the terminals before wiring the temperature sensor.
For RTD temperature sensor, wire it as 3-wire type, using cables in same thickness and length.
For thermocouple (CT) temperature sensor, use the designated compensation wire for extending wire.
- Keep away from high voltage lines or power lines to prevent inductive noise.
In case installing power line and input signal line closely, use line filter or varistor at power line and shielded wire at input signal line.
Do not use near the equipment which generates strong magnetic force or high frequency noise.
- Do not apply excessive power when connecting or disconnecting the connectors of the product.
- Install a power switch or circuit breaker in the easily accessible place for supplying or disconnecting the power.
- Do not use the unit for other purpose (e.g. voltmeter, ammeter), but temperature controller.
- When changing the input sensor, turn off the power first before changing.
After changing the input sensor, modify the value of the corresponding parameter.
- 24VAC, 24-48VDC power supply should be insulated and limited voltage/current or Class 2, SELV power supply device.
- Do not overlapping communication line and power line.
Use twisted pair wire for communication line and connect ferrite bead at each end of line to reduce the effect of external noise.
- Make a required space around the unit for radiation of heat.
For accurate temperature measurement, warm up the unit over 20 min after turning on the power.
- Make sure that power supply voltage reaches to the rated voltage within 2 sec after supplying power.
- Do not wire to terminals which are not used.
- This unit may be used in the following environments.
 - ①Indoors (in the environment condition rated in 'Specifications')
 - ②Altitude max. 2,000m
 - ③Pollution degree 2
 - ④Installation category II

The above specifications are subject to change and some models may be discontinued without notice.

Be sure to follow cautions written in the instruction manual, user manual and the technical descriptions (catalog, homepage).

Table of Contents

Preface	3
User Manual Guide	4
User Manual Symbols	5
Safety Considerations	6
Cautions during Use.....	7
Table of Contents	9
1 Product Introduction.....	13
1.1 Features	13
1.2 Components and Accessories.....	14
1.3 Ordering information	20
1.4 Parts descriptions.....	22
2 Specifications.....	25
3 Dimensions.....	27
4 Connections	33
4.1 Precautions for wiring.....	35
4.1.1 Sensor connection	35
4.1.2 Communication connection.....	36
5 Preparation and Startup	37
5.1 Initial display when power ON.....	37
5.2 Basic controls	38
5.2.1 Parameter setting sequence	38
5.2.2 Set value (SV) setting	38
5.2.3 MV monitoring and manual control	39
5.3 Parameter group	41
5.4 Parameter groups.....	44
5.4.1 Parameter 1 group [PAR 1].....	44
5.4.2 Parameter 2 group [PAR 2].....	45
5.4.3 Parameter 3 group [PAR 3].....	47
5.4.4 Parameter 4 group [PAR 4].....	49
5.4.5 Parameter 5 group [PAR 5].....	52
6 Parameter Settings and Functions.....	55
6.1 Input	55
6.1.1 Input types and temperature ranges	55
6.1.2 Input type [PAR 3 → I n - t].....	56
6.1.3 Sensor temperature unit [PAR 3 → U n i t].....	56
6.1.4 Analog input/scale value	57
6.1.5 Input correction [PAR 3 → I n - b].....	59
6.1.6 Input digital filter [PAR 3 → n A u F]	59
6.1.7 High/Low-limit value of setting value(SV) [PAR 3 → H - S u / L - S u]	60
6.2 Control output.....	61

6.2.1	Control output mode [PAR3 → OFE]	61
6.2.2	MV High/Low-limit value settings [PAR2 → H-nu / L-nu]	66
6.2.3	Ramp settings [PAR2 → rAnu / rAd / rUnE]	67
6.2.4	Auto/Manual control settings	69
6.2.5	Output settings	72
6.3	Temperature control	73
6.3.1	Temperature control mode [PAR3 → [-nd]	73
6.3.2	ON/OFF control [PAR3 → [-nd → ONOFF]	74
6.3.3	PID control [PAR3 → [-nd → PID]	75
6.3.4	Auto-tuning	77
6.4	Alarm output	79
6.4.1	Alarm operation [PAR4 → AL-1/AL-2/AL-3]	79
6.4.2	Alarm output options [PAR4 → AL1E/AL2E]	81
6.4.3	Alarm SV settings [PAR1 → AL1L/AL1H/AL2L/AL2H/AL3L/AL3H]	82
6.4.4	Alarm output hysteresis [PAR4 → A1HY/A2HY/A3HY]	82
6.4.5	Alarm N.O./N.C. [PAR4 → A1n/A2n/A3n]	83
6.4.6	Alarm output delay settings [PAR4 → A1on / A1of / A2on / A2of / A3on / A3of]	84
6.4.7	Loop break alarm(LBA) [PAR4 → AL-1/AL-2/AL-3 → LbA]	85
6.4.8	Sensor break alarm [PAR4 → AL-1/AL-2/AL-3 → SbA]	87
6.4.9	Heater burnout alarm [PAR4 → AL-1/AL-2/AL-3 → HbA]	88
6.4.10	Alarm output deactivation [PAR5 → di-E → ALrE]	90
6.4.11	Alarm output examples	91
6.5	Analog transmission	94
6.5.1	Analog transmission output value settings [PAR4 → Aon 1 / Aon 2]	94
6.5.2	Transmission output high/low-limit value settings [PAR4 → F5L 1 / F5H 1 → F5L 2 / F5H 2]	94
6.6	Communication settings	96
6.6.1	Unit address settings [PAR4 → Adr5]	96
6.6.2	BPS (bits per second) settings [PAR4 → bPS]	96
6.6.3	Communication parity bit [PAR4 → PrtY]	97
6.6.4	Communication stop bit settings [PAR4 → StP]	97
6.6.5	Response wait time settings [PAR4 → r5Yt]	97
6.6.6	Enable/Disable communication write [PAR4 → [-onY]	98
6.6.7	USB to Serial communication connection	98
6.7	Additional features	99
6.7.1	Monitoring	99
6.7.2	RUN/STOP [PAR1 → r-5]	100
6.7.3	Multi SV	101
6.7.4	Digital input	102
6.7.5	Error	104
6.7.6	User level setting [PAR5 → USEr]	105
6.7.7	Lock settings	105
6.7.8	Parameter reset [i n] t]	106
6.7.9	Password settings [PAR5 → Pwd]	106
7	Setting group parameter description	108
7.1	Setting group [5v]	108
7.2	MV monitoring/manual control setting group [nu]	108

7.3	Parameter 1 setting group [<i>PAR 1</i>]	109
7.4	Parameter 2 setting group [<i>PAR 2</i>]	110
7.5	Parameter 3 setting group [<i>PAR 3</i>]	112
7.6	Parameter 4 setting group [<i>PAR 4</i>]	114
7.7	Parameter 5 setting group [<i>PAR 5</i>]	116
7.8	Password entry parameter	117
7.9	Parameter change reset parameters	117
8	DAQMaster	118
8.1	Overview	118
8.2	Major features	119
8.3	Special feature for TK Series	121
8.3.1	Parameter mask	121
8.3.2	User parameter group [<i>PAR U</i>]	123

1 Product Introduction

1.1 Features

TK Series – standard PID temperature controller – realizes more powerful control with super high-speed sampling cycles of 50 ms and $\pm 0.3\%$ display accuracy. It supports diverse control modes including heating & cooling simultaneous control, and automatic/manual control and communication functions. In addition, TK Series covers all necessary features for high performance temperature controllers – that is, diverse input sensor support, multi SV setting, SSR drive output + current output, high resolution display and compact size.

- Improves convenience for parameter setting (using DAQMaster)
 - Parameter mask
To hide parameters which are not unnecessary or not used frequently
 - User parameter group
To group parameters which are used frequently as one group for more convenient setting
- Super high-speed sampling cycle (10 times faster compared to existing models); 50 ms sampling cycle and $\pm 0.3\%$ display accuracy
- Improved visibility with wide display and high luminance LED
- High performance control with heating & cooling control and automatic/manual control modes
- Communication function supported: RS485 (Modbus RTU type)
- PC parameter setting (USB and RS 485 communication)
Free download comprehensive device management program (DAQMaster)
※Communication converter, sold separately
: SCM-WF48 (Wi-Fi to RS485-USB wireless communication converter),
SCM-US48I (USB to RS485 converter), SCM-38I (RS232C to RS485 converter),
SCM-US (USB to serial converter)
- Current output or SSR drive output selectable
- ON/OFF, Cycle, Phase control by SSRP function
- Heater burn-out alarm (CT input) (except TK4SP)
※CT, sold separately: CSTC-E80LN, CSTC-E200LN, CSTS-E80PP
- Multi SV setting function (Max. 4) – selectable via digital input terminals
- Space saving mounting possible with compact design ; downsized by 38% (depth-based)
- Multi-input/multi-range

1.2 Components and Accessories

(1) Components



TK Series

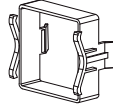
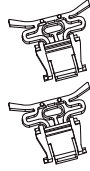

TK4S/SP only

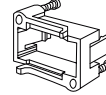

TK4N only

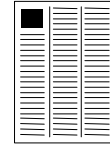

User manual



Note

Make sure all of the above components are included with your product package before use. If a component is missing or damaged, please contact Autonics or your distributor. Visit www.autonics.com to download a copy of the user manual.

(2) Sold separately

Terminal cover

(unit: mm)

- TK4N-COVER (48×24mm)

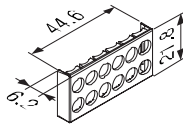

※ The cover for TK4N is an accessory.

- RSA-COVER (48×48mm)

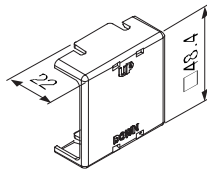

- RMA-COVER (72×72mm)

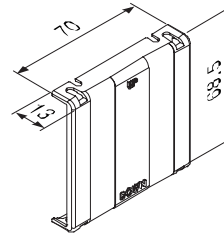

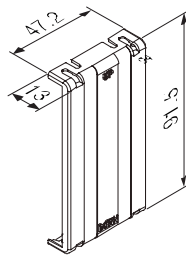

- RHA-COVER (48×96mm, 96×48mm)



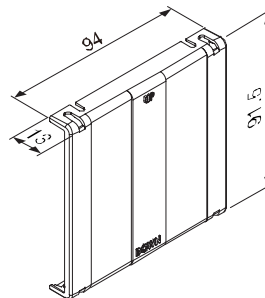

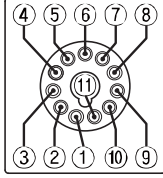
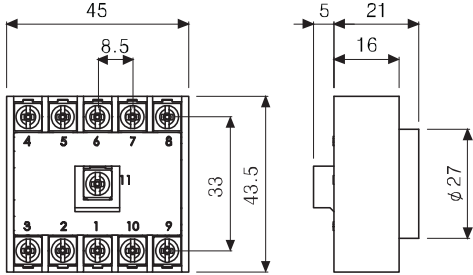

- RLA-COVER (96×96mm)

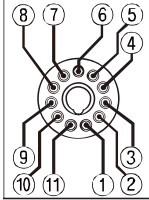
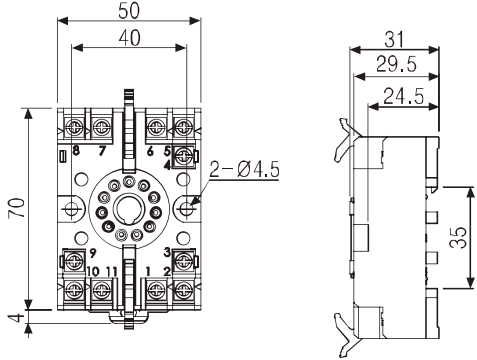

- Socket (for TK4SP) (unit: mm)

<p>PG-11</p> <p>(unit: mm)</p>   	<p>PS-11(N)</p> <p>(unit: mm)</p>   
---	---

- Communication converter

<p>SCM-WF48 (Wi-Fi to RS485-USB wireless communication converter)</p> 	<p>SCM-US48I (USB to RS485 converter)</p> 
<p>SCM-38I (RS232C to RS485 converter)</p> 	<p>SCM-US (USB to Serial converter)</p> 

▪ Current transformer(CT)

CSTC-E80LN

- Max. load current: 80A (50/60Hz)
 ※Max. load current for TK4 Series is 50A.
- Current ratio: 1/1000
- Wire wounded resistance: $31\Omega \pm 10\%$

(unit: mm)

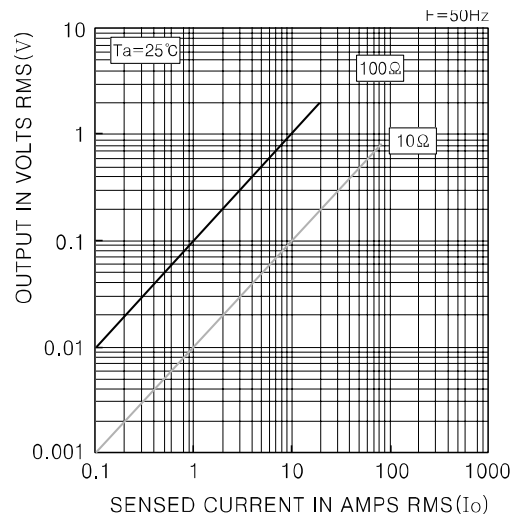
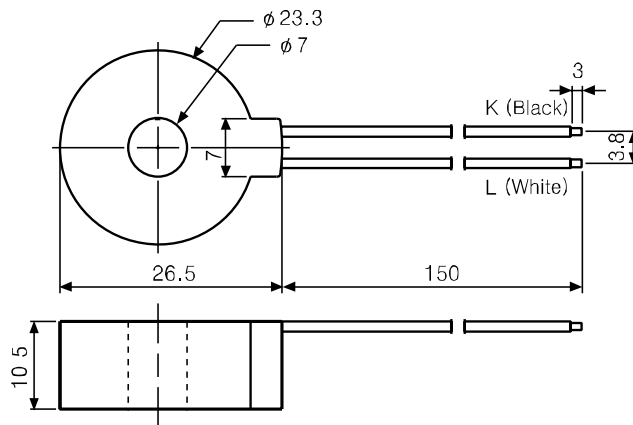

CSTC-E200LN

- Max. load current: 200A (50/60Hz)
 ※Max. load current for TK4 Series is 50A.
- Current ratio: 1/1000
- Wire wounded resistance: $20\Omega \pm 10\%$

(unit: mm)

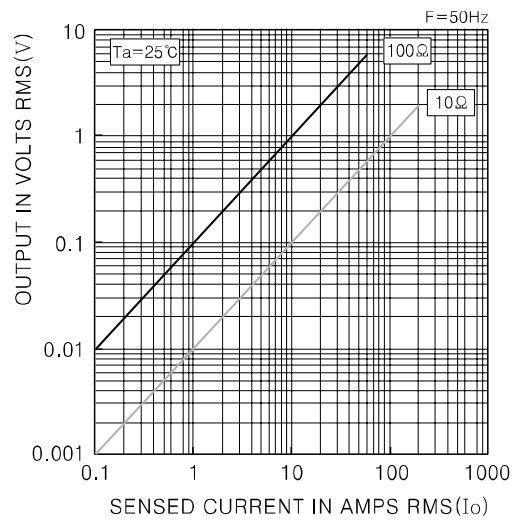
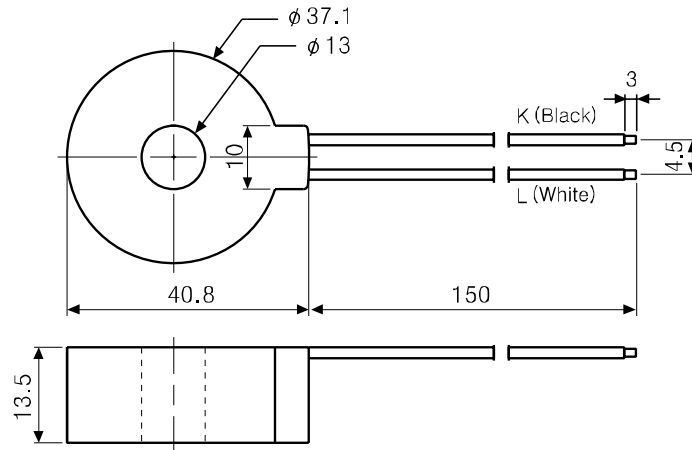

CSTS-E80PP

- Max. load current: 80A (50/60Hz)
 ※Max. load current for TK4 Series is 50A.
- Current ratio: 1/1000
- Wire wounded resistance: $31\Omega \pm 10\%$

(unit: mm)

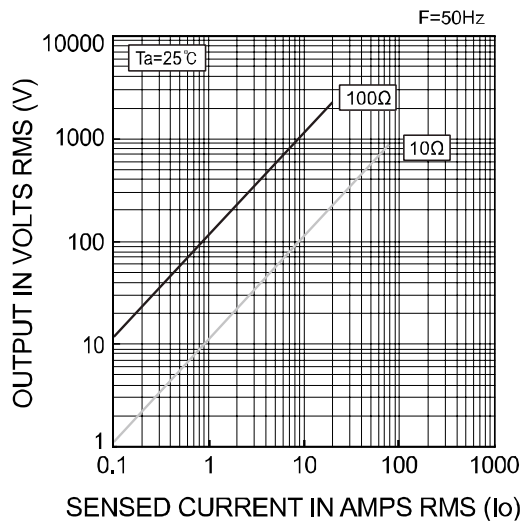
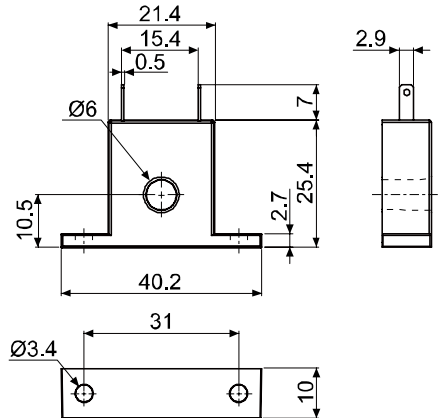

 **Caution**

For using CT, do not supply first part current when opening CT output. It occurs high voltage at CT output part.

Using current of above CTs are same as 50A. But be sure that inner hole sizes are different. Select it properly for the environment.

▪ Display unit

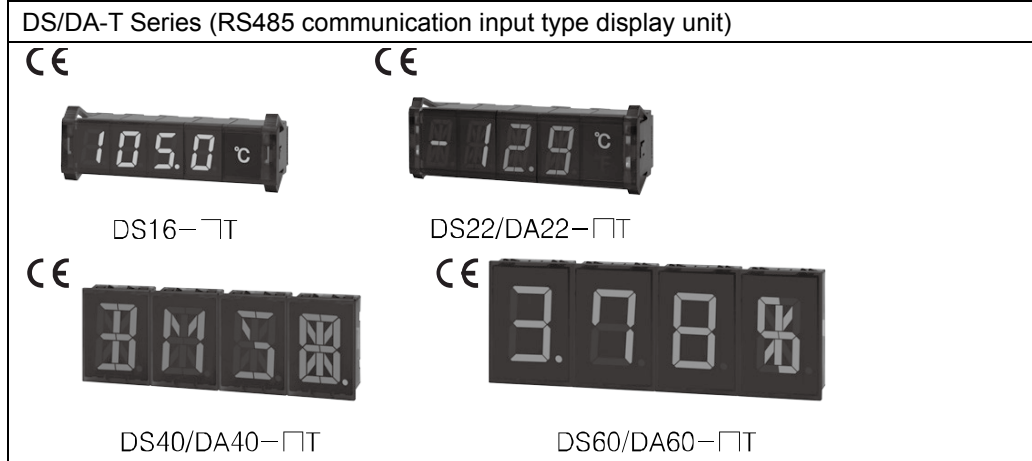

Connect RS485 communication input type display unit (DS/DA-T Series) and TK Series, the display unit displays present value of the device without PC/PLC.

**Note**

Images of components and accessories may differ from actual products.

For detailed information about any of the above products, please refer to the concerned product's user manual.

Visit our website (www.autonics.com) to download copies of the user manuals.

1.3 Ordering information

TK	4	S	-	1	4	R	R
①	②	③		④	⑤	⑥	⑦

Category		Description	
① Item	TK	Temperature/Process controller	
② Digit	4	9999(4digit)	
③ Size	N	DIN W48×H24mm	
	SP	DIN W48×H48mm (11 pin plug type) ^{*1}	
	S	DIN W48×H48mm (terminal block type)	
	M	DIN W72×H72mm	
	W	DIN W96×H48mm	
	H	DIN W48×H96mm	
	L	DIN W96×H96mm	
④ Input/Output Option ^{*2}	N	1	Standard: Alarm output 1+CT input ^{*3} Heating&Cooling: Alarm output 2 ^{*4}
		2	Standard: Alarm output 1+Alarm output 2
		D	Standard: Alarm output 1+Digital input(DI-1, DI-2)
		R	Standard: Alarm output 1+Digital input, Heating&Cooling: Trans. output
		T	Standard: Alarm output 1+RS485com. output Heating&Cooling: RS485com. output
	S P	1	Alarm output 1
		S M W H L	1
	2		Alarm output 1+Alarm output 2
	R		Alarm output 1+Trans. output
	T		Alarm output 1+RS485com. output
	A		Alarm output 1+Alarm output 2+Trans. output
	B		Alarm output 1+Alarm output 2+ RS485 com. output
	D	Alarm output 1+Alarm output 2+ Digital input(DI-1, DI-2) ^{*5}	
	⑤ Power Supply	2 ^{*6}	24VAC 50/60Hz, 24-48VDC
4		100 to 240VAC, 50/60Hz	
⑥ OUT1 Control Output ^{*7}	R	Relay output	
	S ^{*8}	SSR drive output(standard ON/OFF, cycle, phase control)	
	C	Current output or SSR drive output selectable	
⑦ OUT2 Control Output ^{*9}	Standard	N	None ※Select in case of standard control (heating or cooling)
		R	Relay output
	Heating & Cooling ^{*10}	C	Current output or SSR drive output selectable

- ※1. 11Pin socket(PG-11, PS-11(N)): Sold separately
- ※2. In case of TK4N/TK4SP Series, option control output selection and digital input will be limited due to number of terminals.
- ※3. The CT input model of TK4N is selectable only for standard model which has alarm 1.
- ※4. The Heating & Cooling model of TK4N-1□□□ has only alarm output 2.
- ※5. Only for TK4S-D□□□, OUT2 output terminal is used as DI-2 input terminal.
- ※6. Does not support in TK4N.
- ※7. "S" represents SSR drive output support models which SSRP function (standard ON/OFF, cycle, phase)control are available. "C" represents selectable current and SSR drive output support models.
- ※8. Does not support in AC/DC voltage type model.
- ※9. Select "R" or "C" type in case of using heating & cooling control. "N" type in case of using standard control.
- ※10. In case of Relay OUT2 model, alarm output 3 is available only when control output operation mode [□-F□] is set heating [HEAT] or cooling [COOL]. In case of current output, trans. output 2 is available only when control output operation mode [□-F□] is set heating [HEAT] or cooling[COOL].



Note

CT (Current Transformer) input is supported by all models.

However, TK4SP (11 pin plug type) does not support CT input due to its limited number of terminal blocks.

1.4 Parts descriptions

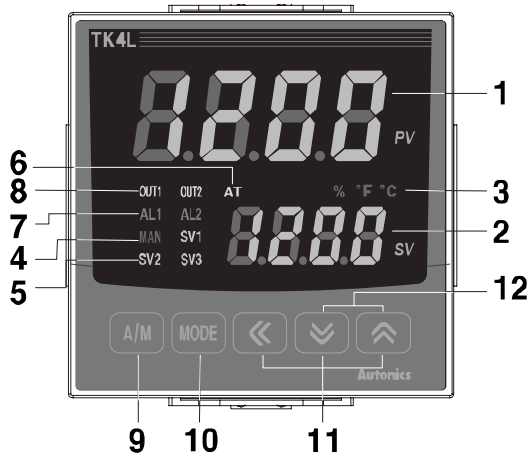

TK4N Series

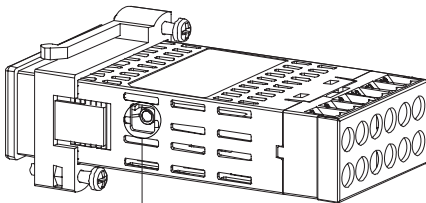

Other Series

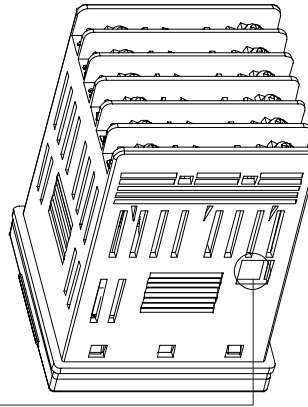





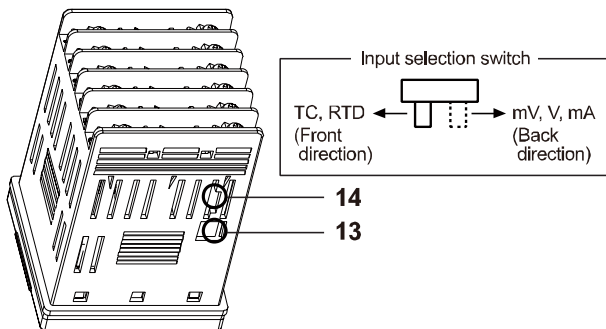



13

The previous model



- ① Measured value(PV) display part:
 RUN mode: It displays currently measured value (PV).
 Setting mode: It displays the parameter.
- ② Set value (SV) display part:
 RUN mode: It displays the set value (SV).
 Setting mode: It displays the set value of the parameter.
- ③ Unit(°C/°F/%) indicator: It displays the unit set at display unit [Unit] in parameter 3 group.
 (TK4N Series does not support '%' unit.)
- ④ Manual control indicator: It turns ON during manual controlling.
- ⑤ Multi SV indicator: One of SV1 to 3 indicator will be ON in case of selecting multi SV function.
- ⑥ Auto tuning indicator: It flashes by 1 sec. when executing auto tuning.

- ⑦ Alarm output (AL1, AL2) indicator: It turns ON when the alarm output is ON.
- ⑧ Control output (OUT1, OUT2) indicator: It turns ON when the control output is ON.
During cycle/phase controlling in SSRP function model (TK4□-□4S□)type, when MV is over 5.0%, it turns ON.
※ To use current output, when MV is 0.0% in manual control, it turns OFF. Otherwise, it always turns ON. When MV is over 3.0% in auto control, it turns ON and when MV is below 2.0%, it turns OFF.
- ⑨  key: It is used when switching auto control to manual control.
※ TK4N/S/SP do not have the  key. The  key operates switching simultaneously.
- ⑩  key: It is used when entering parameter group, returning to RUN mode, moving parameter, saving the set value.
- ⑪    key: It is used when entering the set value changing mode and moving or changing up/down digit.
- ⑫ Digital input key: When pressing the   keys for 3 sec. at the same time, it operates the function (RUN/STOP, alarm clear, auto tuning) set at digital input key [dⁱ - d^l] in parameter 5 group.
- ⑬ PC loader port: It is the PC loader port for serial communication to set parameter and monitoring by DAQMaster installed in PC. Use this for connecting SCM-US(USB to Serial converter, sold separately).
- ⑭ Input selection switch: Used when switching sensor (TC, RTD) input ↔ analog input(mV, V, mA) (only the previous models)





Note

7-Segment Display Characters

A	b	c	d	E	F	G	H	i	J	K	L	M
A	B	C	D	E	F	G	H	I	J	K	L	M
n	o	P	q	r	S	t	U	v	w	X	Y	Z
N	O	P	Q	R	S	T	U	V	W	X	Y	Z
0	1	2	3	4	5	6	7	8	9	0	-1	/
0	1	2	3	4	5	6	7	8	9	0	-1	/

2 Specifications

Series		TK4N	TK4SP	TK4S	TK4M	TK4W	TK4H	TK4L
Power supply	AC voltage	100-240VAC~, 50/60Hz						
	AC/DC voltage	-	24VAC~ 50/60Hz, 24-48VDC=					
Allowable voltage range		±10% of rated voltage						
Power consumption	AC voltage	Max. 6VA	Max. 8VA					
	AC/DC voltage	-	Max. 8VA(24VAC~ 50/60Hz), max. 5W(24-48VDC=)					
Display method		7-segment (PV: red, SV: green), other display part (green, yellow, red) LED method						
Character size	PV(W×H)	4.5 × 7.2 mm	7.0×14.0mm		9.5×20.0 mm	8.5×17.0 mm	7.0×14.6 mm	11.0×22.0 mm
	SV(W×H)	3.5 × 5.8 mm	5.0×10.0mm		7.5×15.0 mm	6.0×12.0 mm	6.0×12.0 mm	7.0×14.0 mm
Input type	RTD	JPt 100Ω, DPt 100Ω, DPt 50Ω, Cu 100Ω, Cu 50Ω, and Nikel 120Ω (6 types)						
	TC	K, J, E, T, L, N, U, R, S, B, C, G, and PLII (13 types)						
	Analog	Voltage: 0-100mV, 0-5V, 1-5V, and 0-10V (4 types) Current: 0-20mA and 4-20mA (2 types)						
Display accuracy	RTD	At room temperature (23°C ± 5°C): (PV ± 0.3% or ± 1°C, select the higher one) ± 1-digit ^{※1}						
	TC	Out of room temperature ranges: (PV ± 0.5% or ± 2°C, select the higher one) ± 1-digit In case of TK4SP Series, ±1°C will be added.						
	Analog	At room temperature (23°C ± 5°C): ± 0.3% F.S. ± 1-digit Out of room temperature ranges: ± 0.5% F.S. ± 1-digit						
	CT Input	± 5% F.S. ± 1 digit						
Control output	Relay	OUT1, OUT2: 250VAC~ 3A 1a						
	SSR	Max.11VDC= ± 2V 20mA						
	Current	DC4-20mA or DC0-20mA selectable (resistance load max. 500Ω)						
Alarm output	Relay	AL1, AL2: 250VAC~ 3A 1a (TK4N AL2: 250VAC~ 0.5A 1a (max. 125VA), TK4SP has only AL1)						
Option output	Transmission output	DC4-20mA (resistance load max. 500Ω, output accuracy: ±0.3% F.S)						
	Comm.	RS485 Communication Output (Modbus RTU)						
Option input	CT	0.0-50.0A (primary heater current reading range) ※CT Ratio is 1/1000 (except TK4SP)						
	Digital input	Contact input - ON: max. 2kΩ, OFF: min. 90kΩ Non-Contact input - ON: residual voltage max. 1.0VDC=, OFF: leakage current min. 0.1mA Leakage current: approx. 0.5mA per input ※TK4S/M: 1 (TK4S-D□□□: 2, TK4SP: None), TK4N/H/W/L: 2 (except TK4SP)						
Control type	Heating, cooling	ON/OFF, P, PI, PD, PID control mode						
	Heating& Cooling							
Hysteresis		RTD/ Thermocouples: 1 to 100°C/°F (0.1 to 100.0°C/°F) variable Analog: 1 to 100-digit						
Proportional band (P)		0.1 to 999.9°C/°F (0.1 to 999.9%)						

Integral time (I)	0 to 9999sec					
Derivative time (D)	0 to 9999sec					
Control period (T)	Relay output, SSR drive output: 0.1 to 120.0 sec Current output+SSR drive output: 1.0 to 120.0 sec					
Manual reset value	0.0 to 100.0%					
Sampling period	50 ms					
Dielectric strength	2,000 VAC 50/60 Hz for 1 min (between power source terminal and input terminal)					
Vibration resistance	0.75mm amplitude at frequency 5 to 55 Hz (for 1 min) in each X, Y, Z direction for 2 hours					
Relay life cycle	Mechanical	OUT1/OUT2: min. 5,000,000 operations AL1/2: min. 20,000,000 operations (TK4H/W/L: Min. 5,000,000 operations)				
	Electrical	OUT1/OUT2, AL1/2: min. 100,000 operations				
Insulation resistance	Over 100MΩ (at 500VDC megger)					
Noise resistance	Square shaped noise by noise simulator (pulse width 1 μs) ±2 kV R-phase, S-phase					
Memory retention	Approx. 10 years (non-volatile semiconductor memory type)					
Environment	Ambient temp.	-10 to 50°C, storage: -20 to 60°C				
	Ambient humi.	35 to 85% RH, storage: 35 to 85% RH				
Protection	IP65 (front panel) ※TK4SP: IP50 (front panel)					
Insulation type	Double insulation or reinforced insulation (mark: ) , dielectric strength between the measuring input part and the power part: 2kV)					
Approval						
Weight ^{※2}	Approx. 140 g (approx. 70 g)	Approx. 130 g (approx. 85 g)	Approx. 150 g (approx. 105 g)	Approx. 210 g (approx. 140 g)	Approx. 211 g (approx. 141 g)	Approx. 249 g (approx. 198 g)

※1. At room Temperature range(23°C ± 5°C)

- TC K, J, T, N, E type, below -100°C / TC L, U, PLII, RTD Cu50Ω, DPt50Ω: (PV ±0.3% or ±2°C, select the higher one) ± 1-digit
- TC C, G, R, S type bellow 200°C: (PV ±0.3% or ±3°C, select the higher one) ± 1-digit
- TC B type, below 400°C: there is no accuracy standard.

Out of room temperature range

- RTD Cu50Ω, DPt50Ω: (PV ±0.5% or ±3°C, select the higher one) ±1-digit
- TC R, S, B, C, G type: (PV ±0.5% or ±5°C, select the higher one) ±1-digit
- Others, Below -100°C, within ±5°C

In case of TK4SP Series, ±1°C will be added to the degree standard.

※2. The weight includes packaging. The weight in parenthesis is unit only.

※Environment resistance is rated at no freezing or condensation.

3 Dimensions

(unit: mm)

(1) TK4N Series

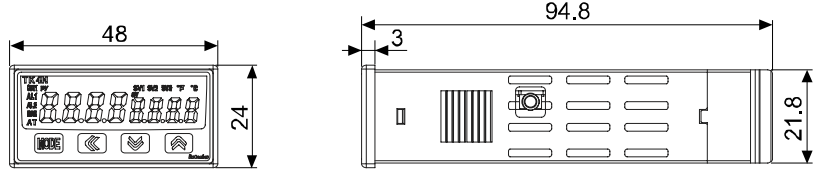

(2) TK4S Series

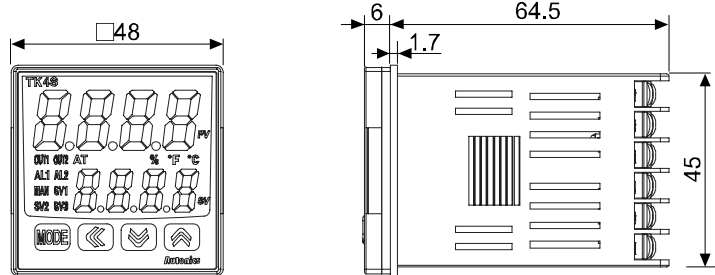

(3) TK4SP Series

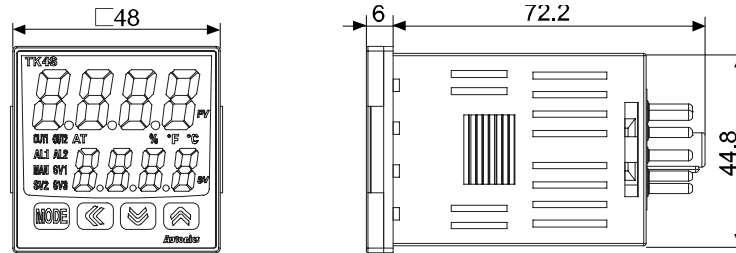

(4) TK4M Series

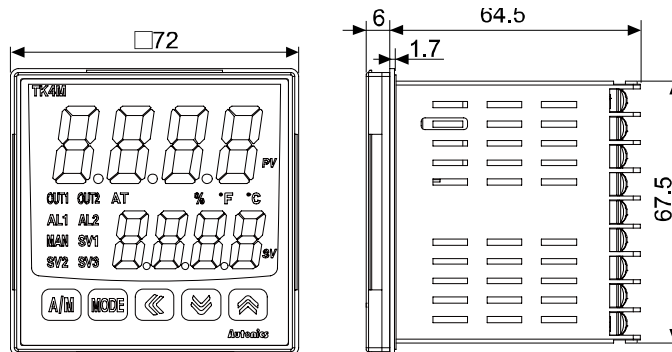

(5) TK4H Series

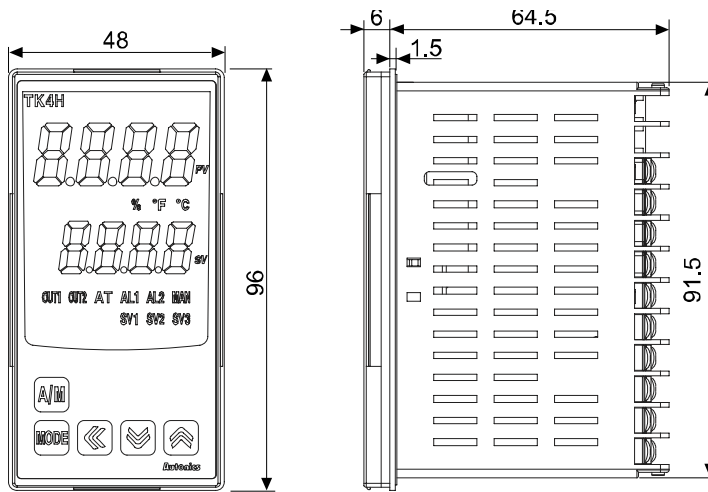

(6) TK4W Series

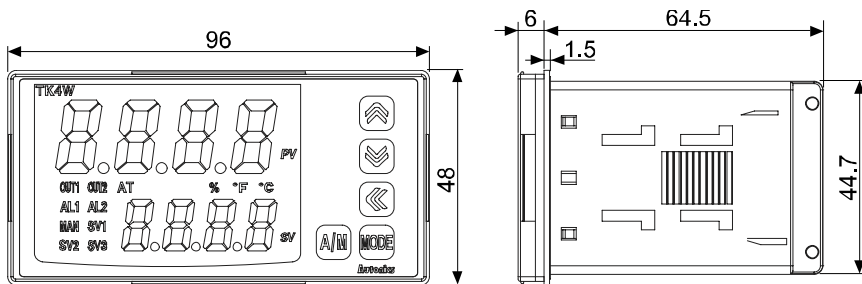

(7) TK4L Series

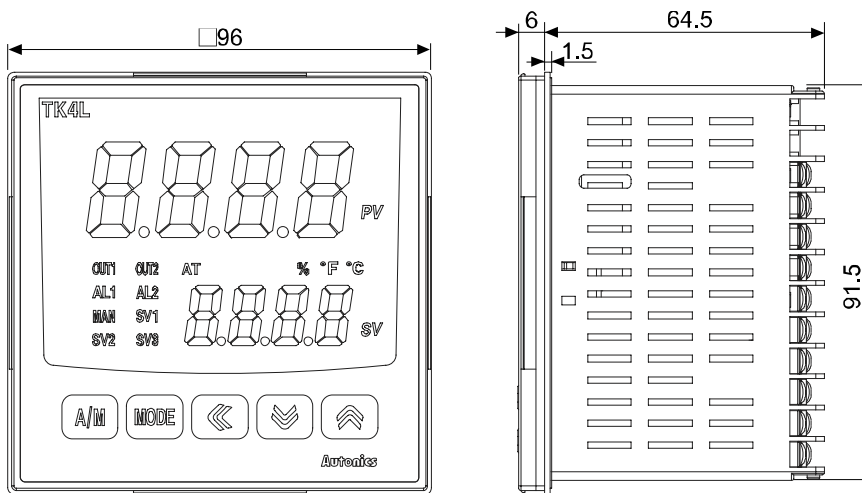

(8) Bracket

- TK4N Series

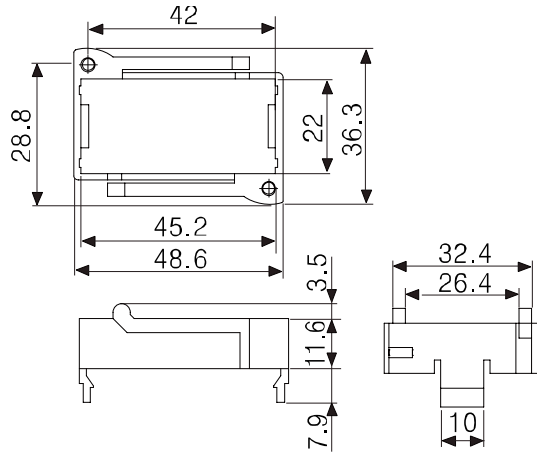

- TK4S, TK4SP Series

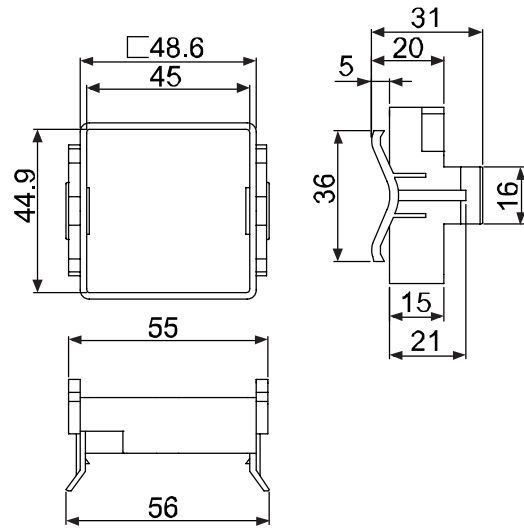

- TK4M/W/H/L Series

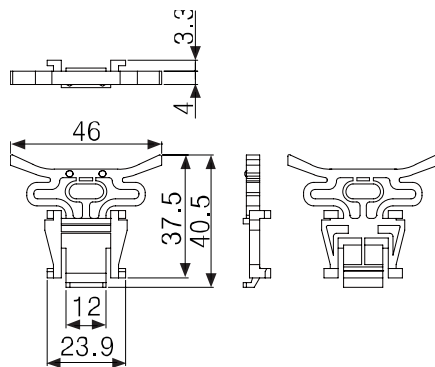

(9) Terminal cover (sold separately)

- TK4N COVER (48×24mm)

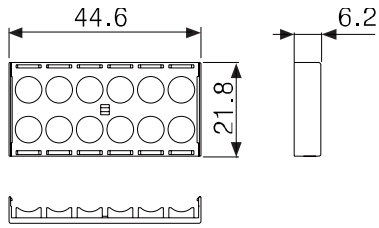

※TK4N COVER is accessory.

- RSA-COVER (48×48mm)

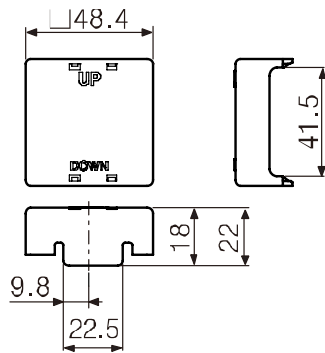

- RMA-COVER (72×72mm)

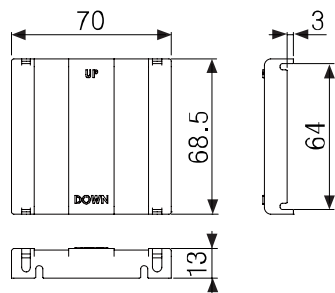

- RHA-COVER (48×96mm, 96×48mm)

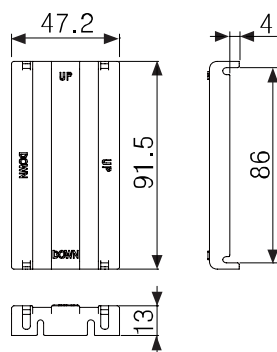

(10) Panel cut-out

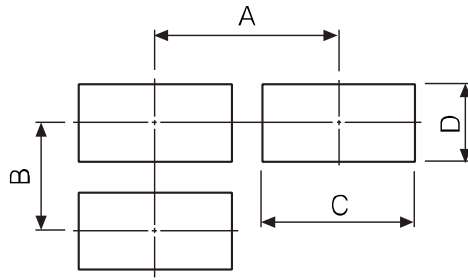

(unit: mm)

Model	Size	A	B	C	D
TK4N		Min. 55	Min. 37	$45^{+0.6}_0$	$22.2^{+0.3}_0$
TK4S		Min. 65	Min. 65	$45^{+0.6}_0$	$45^{+0.6}_0$
TK4SP		Min. 65	Min. 65	$45^{+0.6}_0$	$45^{+0.6}_0$
TK4M		Min. 90	Min. 90	$68^{+0.7}_0$	$68^{+0.7}_0$
TK4H		Min. 65	Min. 115	$45^{+0.6}_0$	$92^{+0.8}_0$
TK4W		Min. 115	Min. 65	$92^{+0.8}_0$	$45^{+0.6}_0$
TK4L		Min. 115	Min. 115	$92^{+0.8}_0$	$92^{+0.8}_0$

Installation

TK4N	TK4S/SP	Other Series
<p>(+) driver</p>	<p>(-) driver</p>	<p>(-) driver</p>
<p>Insert the unit into a panel fasten the bolt with a (+) driver.</p>	<p>Insert the unit into a panel fasten the bracket by pushing with tools with a (-) driver.</p>	

4 Connections

Be sure that the polarity for input connecting a temperature sensor or analog input. Standard model has shaded terminals only.

When the operation mode of heating&cooling OUT2 relay output model is heating or cooling control, the OUT2 is usable as alarm output 3(except TK4N).

When the operation mode of heating & cooling OUT2 current model is heating or cooling control, the OUT2 is usable as transmission output 2.

(1) TK4N Series

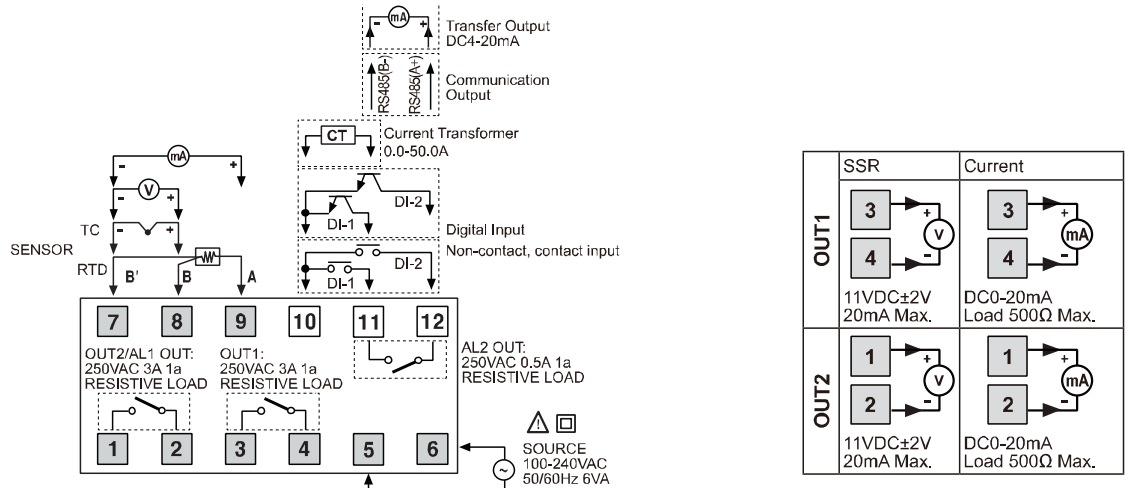

(2) TK4S Series

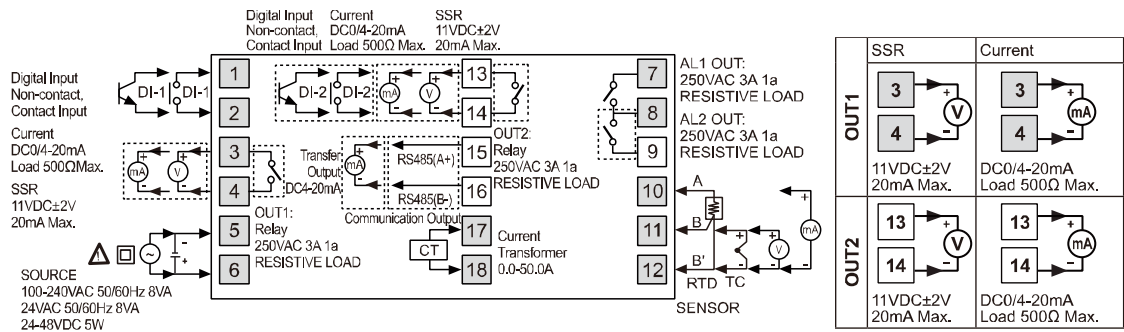

Note

Features one digital input terminal (DI-1) due to limited number of terminal blocks. Supports two multi SVs (SV1 and SV2) only.

(3) TK4SP Series

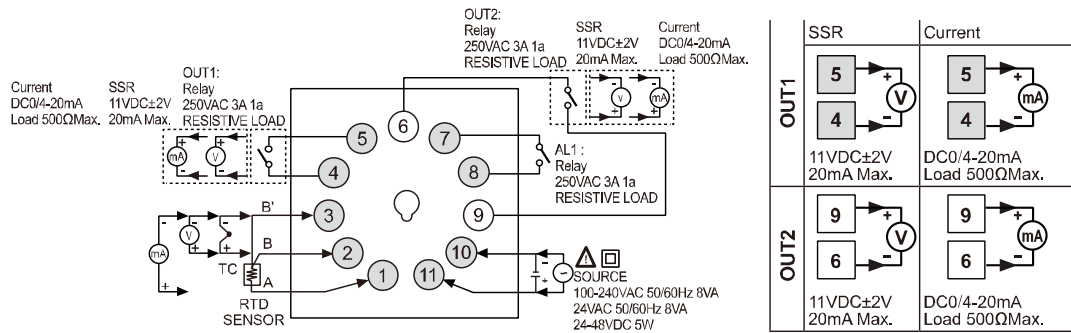

Note

Does not feature any digital input terminal due to limited number of terminal blocks.
11Pin Socket(PG-11, PS-11): Sold separately

(4) TK4M Series

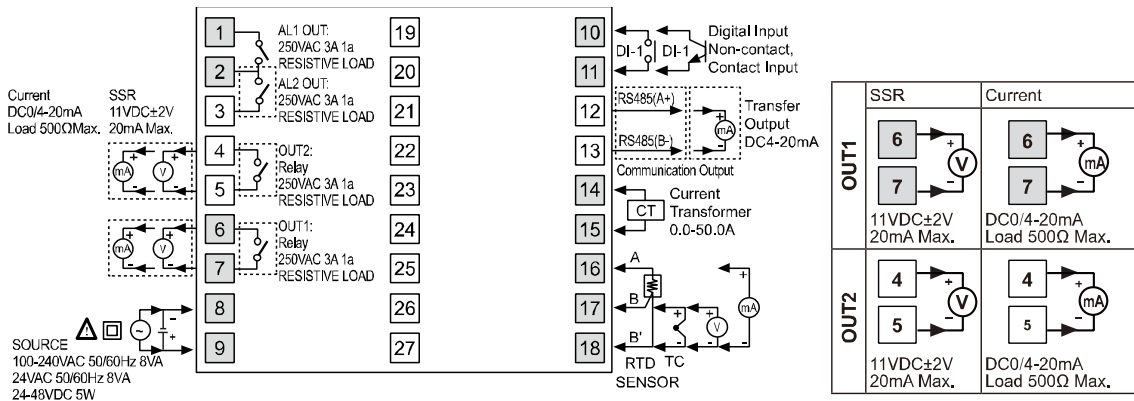

Note

Features one digital input terminal (DI-1) due to limited number of terminal blocks. Supports two multi SVs (SV1 and SV2) only.

(5) TK4W, TK4H, TK4L Series

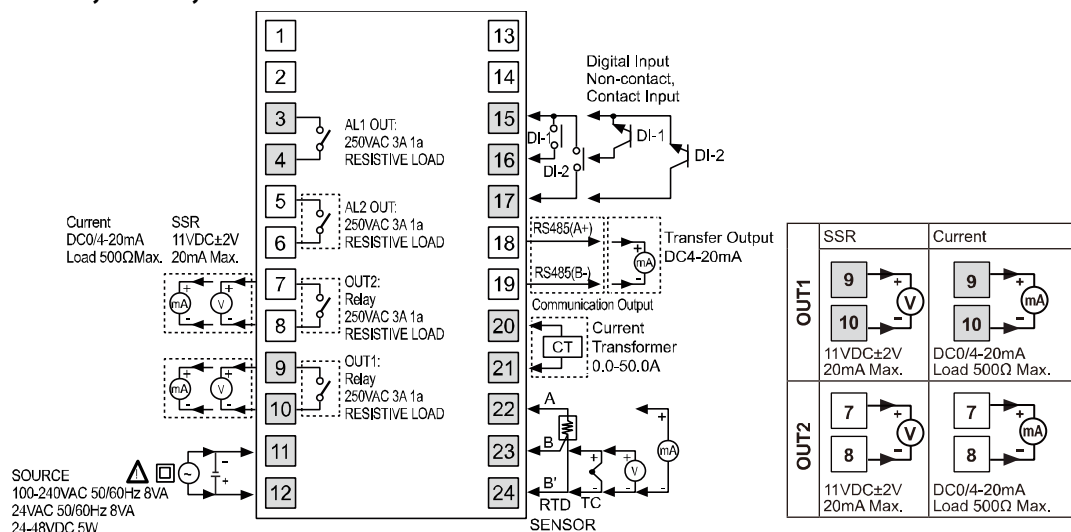

※ Digital input is not electrically insulated from internal circuits, so it should be insulated when connecting other circuits. (photocoupler, relay, independent switch)

4.1 Precautions for wiring

- Mixing up the input terminals with output terminals and vice versa can lead to product damage.
- Use only sensors supported by the product.
- Make sure to connect rated SSRs or loads to the output terminals. Make sure to connect communication cable with correct communication terminals (A, B).
- Make sure to observe correct polarity of power source terminals. (+ and -).
- Make sure to connect correct polarity of temperature sensor and analog input.
- Use terminals of size specified below.

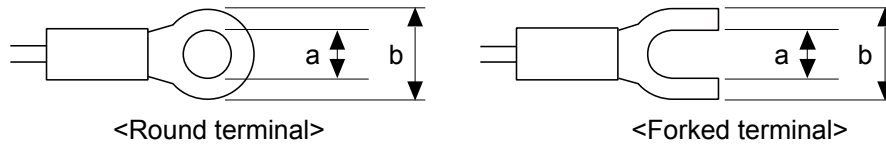

	a	b
Round terminal	Min. 3.0mm	Max. 5.8mm
Forked terminal	Min. 3.0mm	Max. 5.8mm

4.1.1 Sensor connection

- Compensation Wire Connection
For thermocouple sensors, use compensation wire of the same specification as input sensors. Using an extension wire of different specifications and/or material will increase inaccuracy of temperature sensing. It is recommended to choose high performance compensation wire for more reliable sensing.
- Measurement Error
Do not mix up the direction of the input sensor connector.
Carefully adjust both load and sensor positions.
Make sure the sensor is securely attached to the input connector.
- AC Power Cable and Wiring
Do not put the sensor lines in close proximity of the AC power lines.

4.1.2 Communication connection

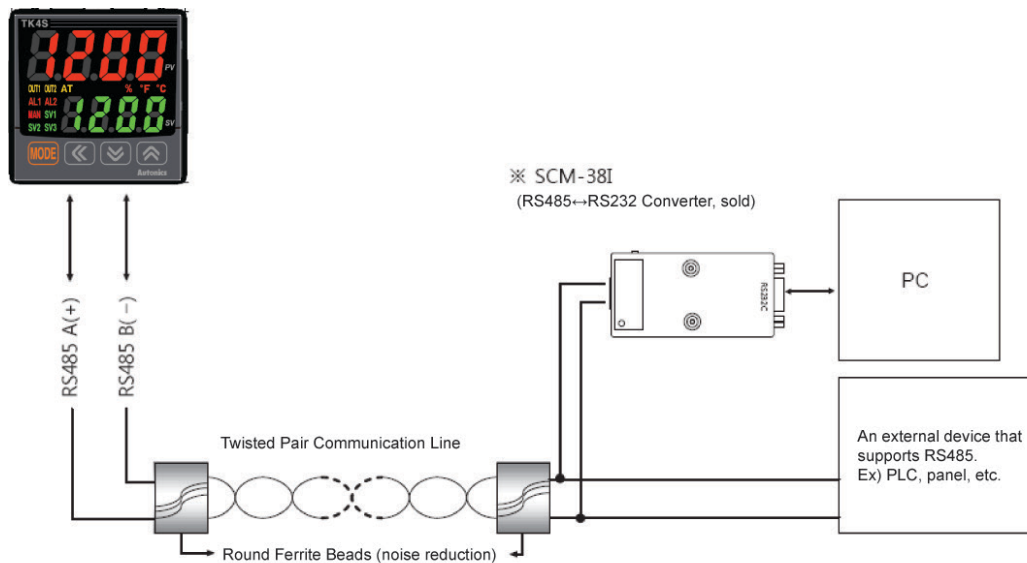

Note





Do not tie together with the AC power line and communication line. Only use twisted pair wires for the communication lines. Do not allow the communication line to exceed 800m in length.

For further details, please refer to '6.6 Communication'.

5 Preparation and Startup

5.1 Initial display when power ON

When power is supplied, whole display parts flash for 1 sec. Afterwards, model name and input sensor type will be flash twice and then in enters into RUN mode.

① Whole display part	② Model type display	③ Input type display twice	④ RUN mode
			

SV display part	Display type	Type			
l, 2, d, r, t	TK4N	l	Standard: Alarm output1+CT input Heating & Cooling: Alarm output2		
		2	Standard: Alarm output1+Alarm output2		
		d	Standard: Alarm output1+Digital input(DI-1, DI-2) Heating & Cooling: Digital input (DI-1, DI-2)		
		r	Standard: Alarm output1+Trans. output Heating & Cooling: Trans. output		
l, 2, r, t, R, b, d	TK4S/SP/M/W/H/L	t	Standard: Alarm output1+RS485 com. output Heating & Cooling: RS485 comm. output		
		l	Alarm output1		
		2	Alarm output1+Alarm output2		
		r	Alarm output1+ Trans. output		
		t	Alarm output1+RS485 com. output		
		R	Alarm output1/2+ Trans. output		
4	Power supply		100-240VAC 50/60Hz		
		r, 5, t	OUT1 control output	r	Relay contact
				5	SSR drive output (standard ON/OFF, cycle, phase control)
t	Current + SSR drive output				
n, r, t	OUT2 control output	n	None		
		r	Relay contact		
		t	Current + SSR drive output		

5.2 Basic controls

5.2.1 Parameter setting sequence

Parameters of each group are connected each other. Therefore, follow the below parameter order.







Parameter 3 Group [P_{RR} 3] → Parameter 4 Group [P_{RR} 4] → Parameter 5 Group [P_{RR} 5] →
Parameter 2 Group [P_{RR} 2] → Parameter 1 Group [P_{RR} 1] → SV Setting [5_U]



Note

Changing Parameter 3 Group's parameters can sometimes reset other associated parameters. Always make sure to check if such parameters have been affected.

5.2.2 Set value (SV) setting

①		<p>Press any key among , ,  in RUN mode to enter SV setting mode. Last digit (10⁰ digit) on SV display part flashes.</p>
②		<p>Press the  key to move digit. (10⁰ → 10¹ → 10² → 10³ → 10⁰)</p>
③		<p>Press the ,  keys to raise or lower the set value.</p>
④		<p>Press the  key to save the set value. If there is no additional key operations in 3 sec., the changed SV is automatically saved.</p>

5.2.3 MV monitoring and manual control

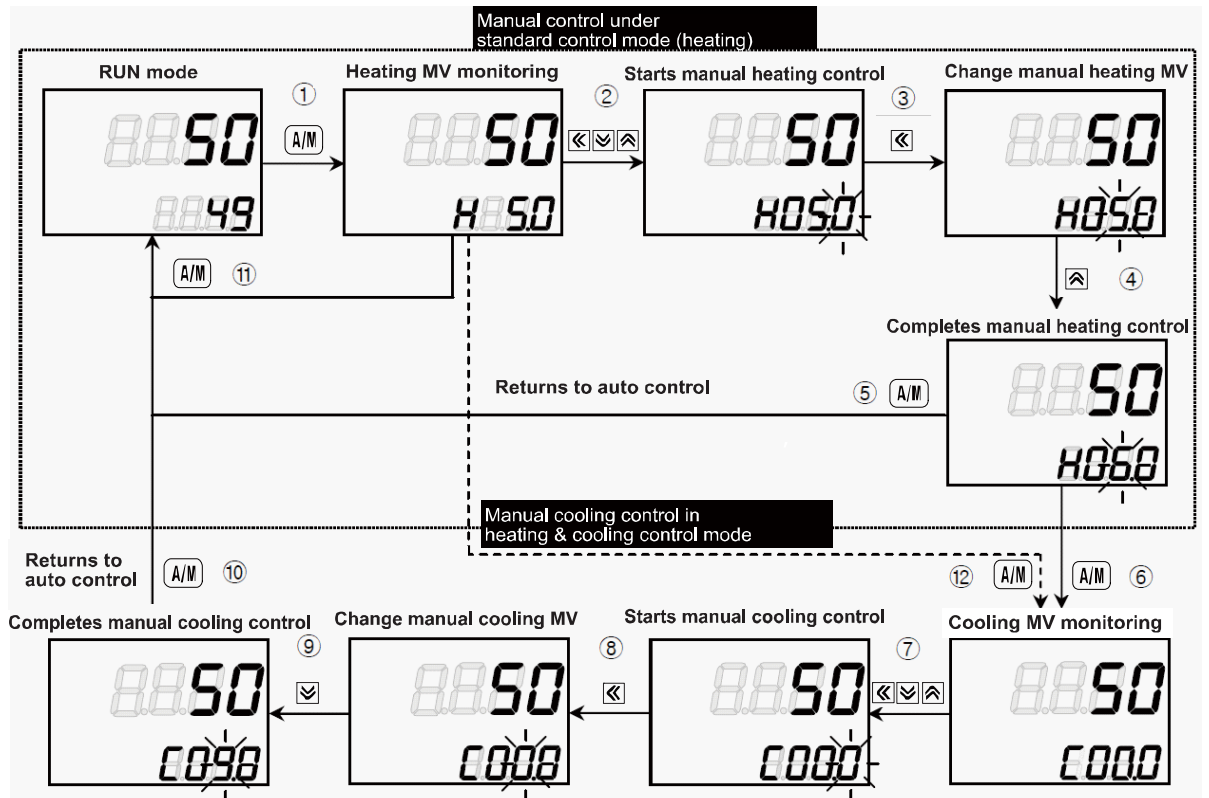

- ① While in RUN mode, press the (A/M) key to commence manual control. The SV display will then show H (heating control) or C (cooling control) and simultaneously display the MV to indicate commencement of MV monitoring.
- ② If the ⏪, ⏴, or ⏵ is pressed while MV monitoring is in progress, the MAN indicator will turn on and the last digit will start to flash to indicate activation of manual control.
- ③ Press the ⏪ key to change the flashing digit ($10^0 \rightarrow 10^1 \rightarrow 10^2 \rightarrow 10^3 \rightarrow 10^0$).
- ④ Select the digit and configure the desired MV value using the ⏴, ⏵ keys.
- ⑤ To end manual control, press the (A/M) key. The MAN indicator will turn off, and the system will revert to auto control mode.
- ⑥ While in heating & cooling control mode, set the manual heating MV and then press the (A/M) key to see C (cooling control) and the current cooling MV value on the SV display indicating commencement of cooling MV monitoring.
- ⑦ If the ⏪, ⏴, or ⏵ is pressed while MV monitoring is in progress, the MAN indicator turns on and the last digit starts to flash to indicate activation of manual control.
- ⑧ Press the ⏪ key to change the flashing digit ($10^0 \rightarrow 10^1 \rightarrow 10^2 \rightarrow 10^3 \rightarrow 10^0$).
- ⑨ Select the digit and configure desired cooling MV value using the ⏴, ⏵ keys.
- ⑩ To end manual control, press the (A/M) key. The MAN indicator will turn off, and the system will revert to auto control mode.
- ⑪ While in standard control mode (heating control or cooling control), pressing the (A/M) key once from the MV monitoring stage, or any other stage, will revert the system to auto control mode.
- ⑫ During heating & cooling control mode, pressing the (A/M) key once from the MV monitoring stage, or any other stage, will skip the system to the cooling MV monitoring stage.

**Note**

For heating & cooling control, the system reverts to auto control after going through heating monitoring, manual heating control, cooling monitoring, and manual cooling control stages in sequence.

Heating MV remains in effect during cooling monitoring and manual cooling control.

When setting digital input function as AUTO/MANUAL, MV monitoring and control status

Control status	MV	Monitoring
AUTO	Not changed	Available
MANUAL	Changeable	

TK4N/S/SP model's the **(MODE)** key alternates the **(A/M)** key.

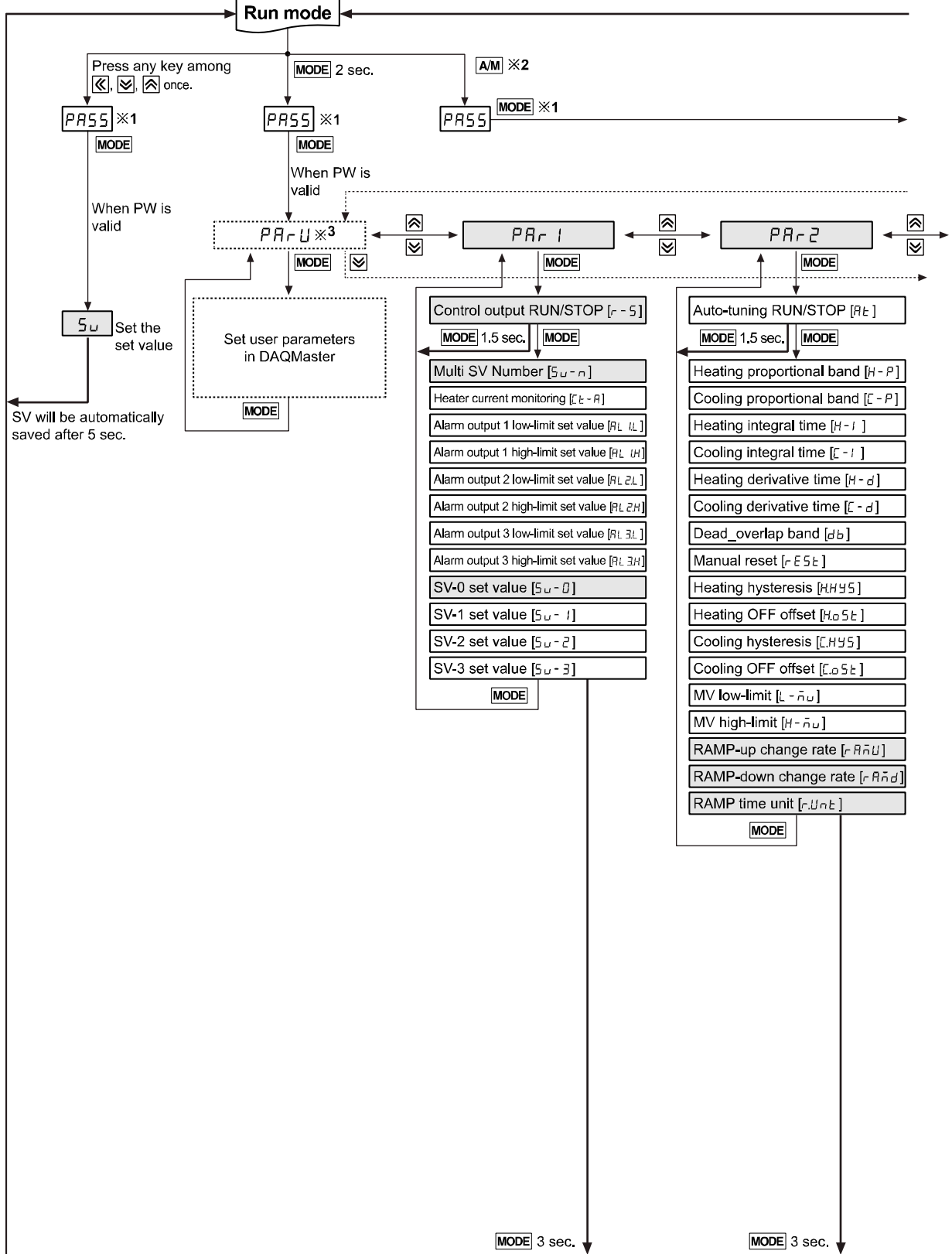

5.3 Parameter group

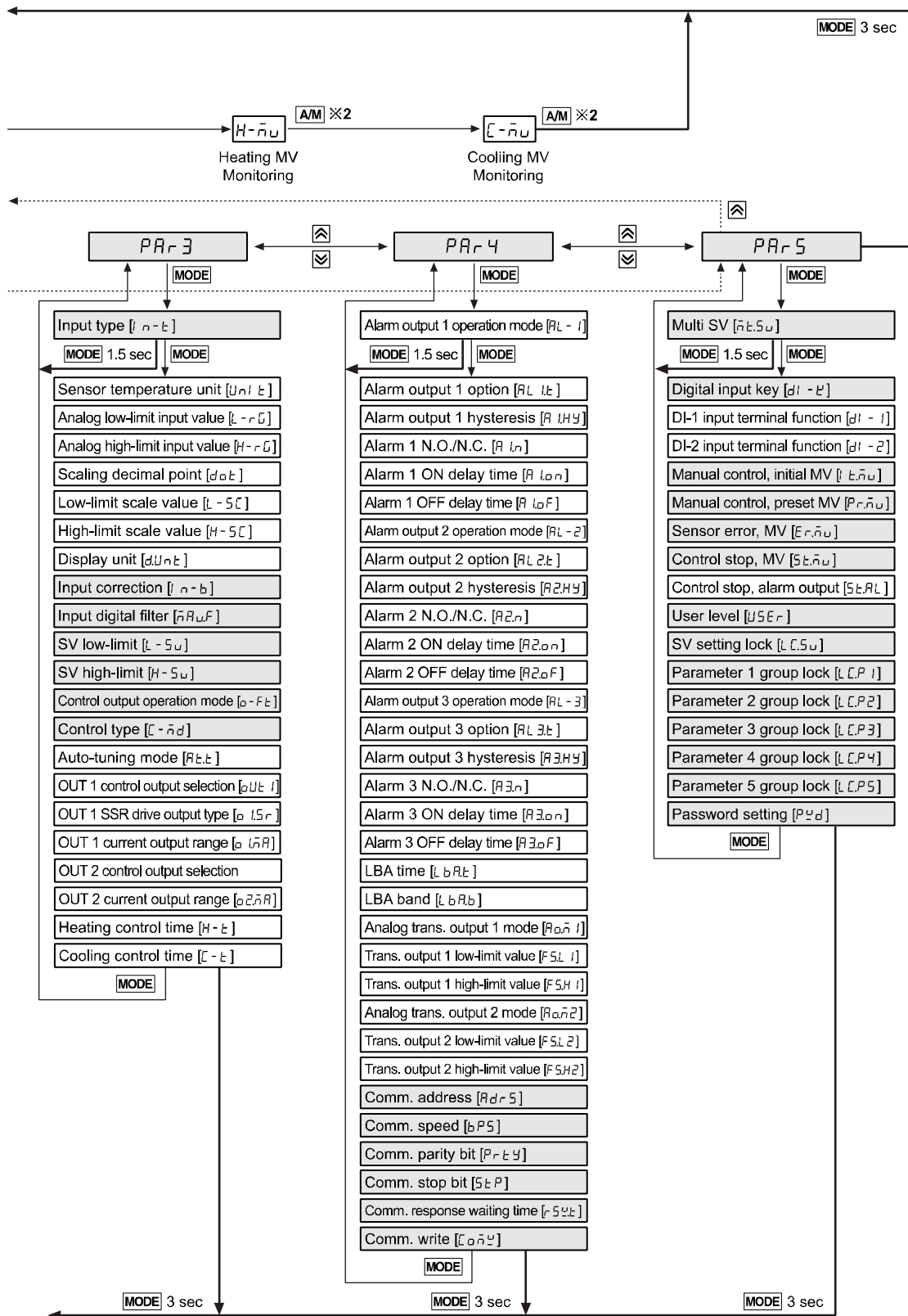







※1. *PASS* parameter will be displayed only when password is set. It is not displayed when purchasing the unit since default password is set to `0000`.

If password is not valid, the screen will be shifted to password code required window.

Press any key among    to return to password entering window. Press

 key to return to RUN mode.





In case you forget password, contact Autonics after checking password code.

※2. TK4N/4S/4SP do not have  key. The  key replaces  key.

※3. It is displayed when setting user parameter group in the comprehensive device management program (DAQMaster).



Note

- Hold the  key over 2 sec in RUN mode to enter into setting mode.
- Hold the  key for 1.5 sec while in setting mode to move to other parameter group.
- Hold the  key over 3 sec while in setting mode to return to RUN mode.
- Press the  key at the last parameter of each parameter, it moves to that parameter name. You can move to other groups.
- If there is no additional key operation within 30 sec after entering into setting mode, it will be automatically returned to RUN mode and previous setting value will be remained
- The shaded parameters are displayed in common.
The others may not be displayed by the specifications of the product, other parameter's setting, or parameter mask setting.

5.4 Parameter groups

5.4.1 Parameter 1 group [PAR 1]

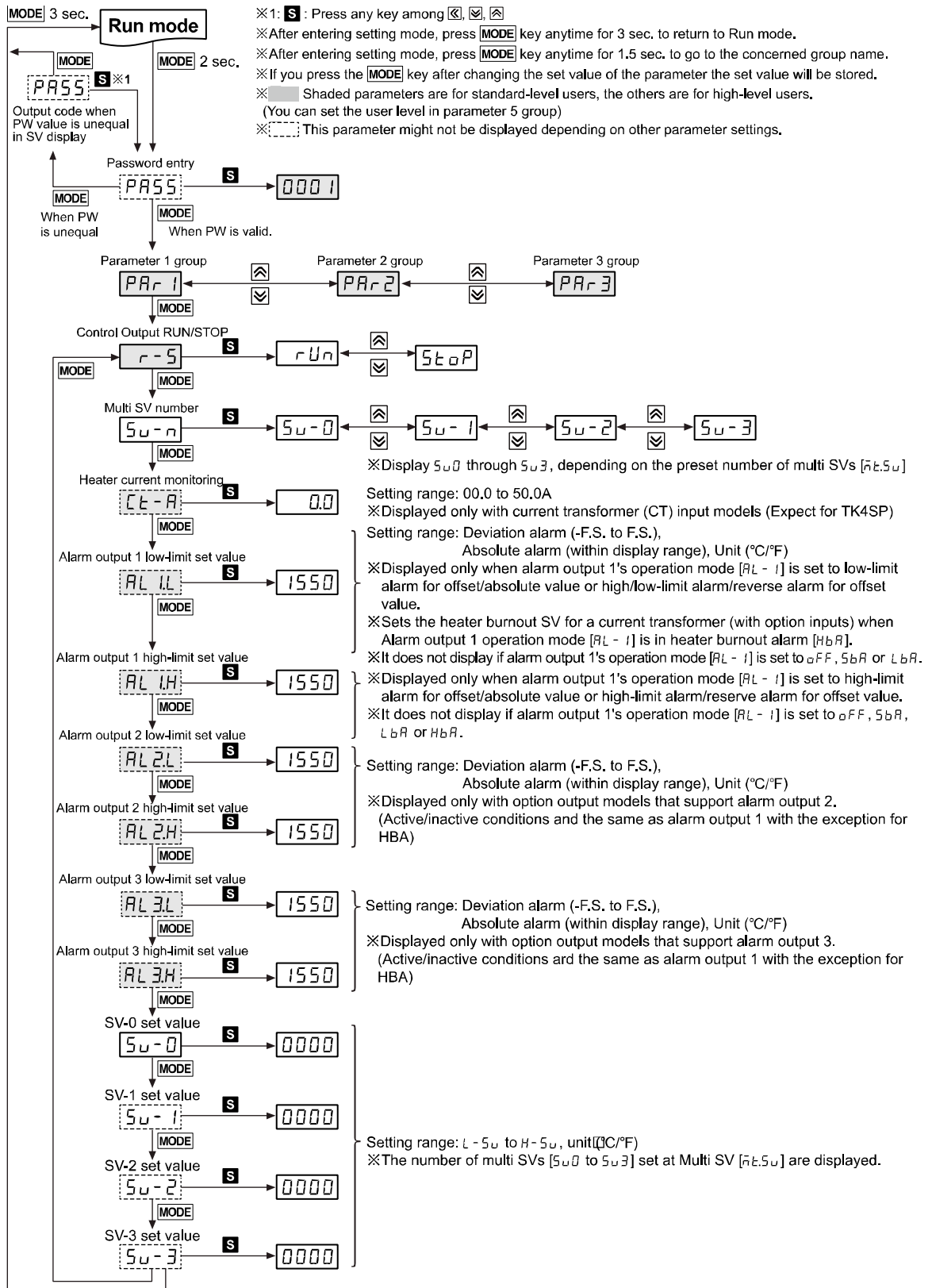

5.4.2 Parameter 2 group [PAR2]

- ※1: **S**: Press any key among \leftarrow , \rightarrow , \uparrow
- ※After entering setting mode, press **MODE** key anytime for 3 sec. to return to Run mode.
- ※After entering setting mode, press **MODE** key anytime for 1.5 sec. to go to the concerned group name.
- ※If you press the **MODE** key after changing the set value of the parameter the set value will be stored.
- ※ Shaded parameters are for standard-level users, the others are for high-level users.
(You can set the user level in parameter 5 group)
- ※: This parameter might not be displayed depending on other parameter settings.

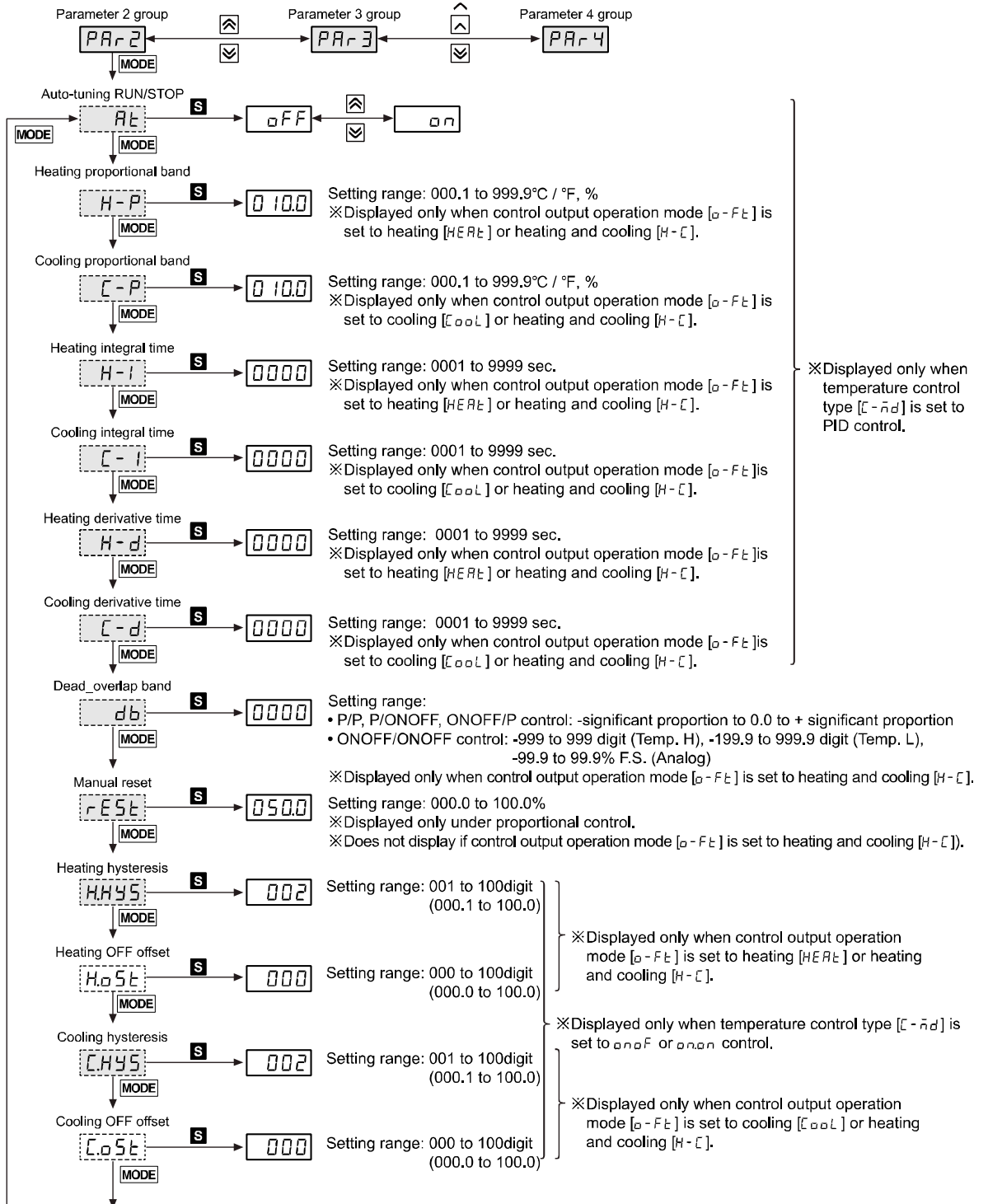

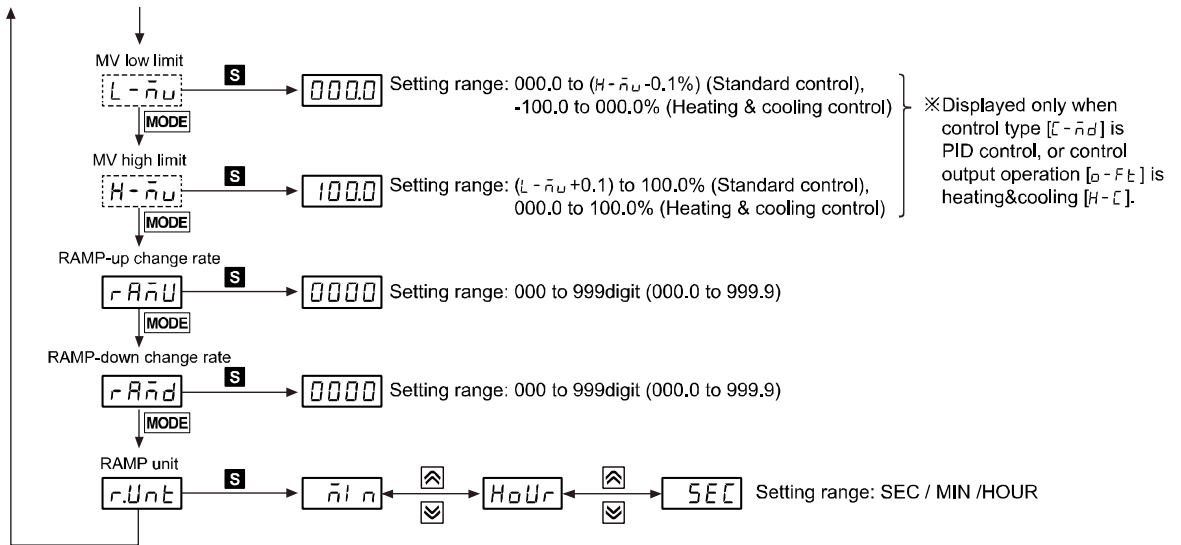

5.4.3 Parameter 3 group [PAR3]

- ※1: **S** : Press any key among \leftarrow , \rightarrow , \uparrow , \downarrow
- ※After entering setting mode, press **MODE** key anytime for 3 sec. to return to Run mode.
- ※After entering setting mode, press **MODE** key anytime for 1.5 sec. to go to the concerned group name.
- ※If you press the **MODE** key after changing the set value of the parameter the set value will be stored.
- ※ Shaded parameters are for standard-level users, the others are for high-level users.
(You can set the user level in parameter 5 group)
- ※ This parameter might not be displayed depending on other parameter settings.

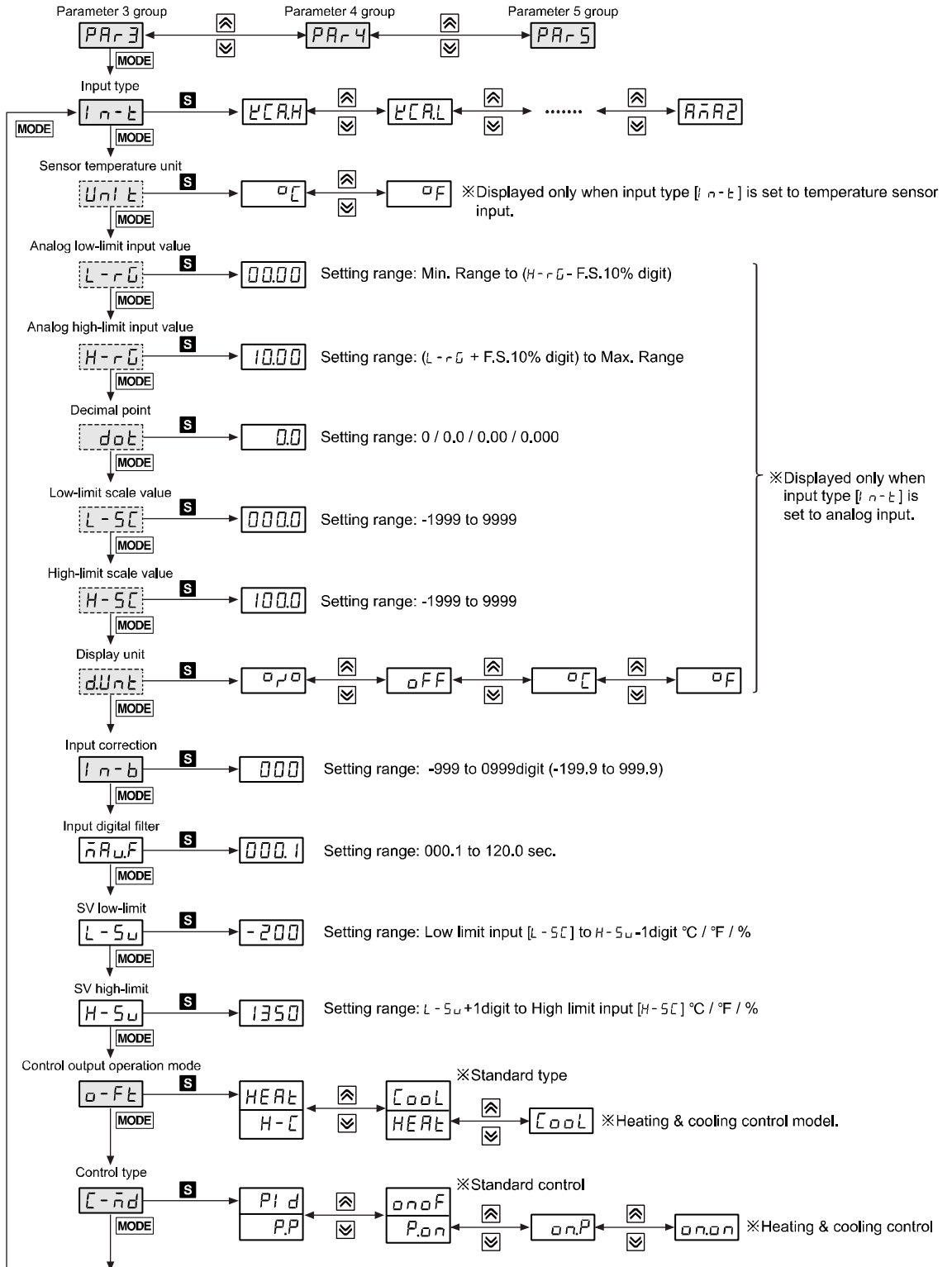

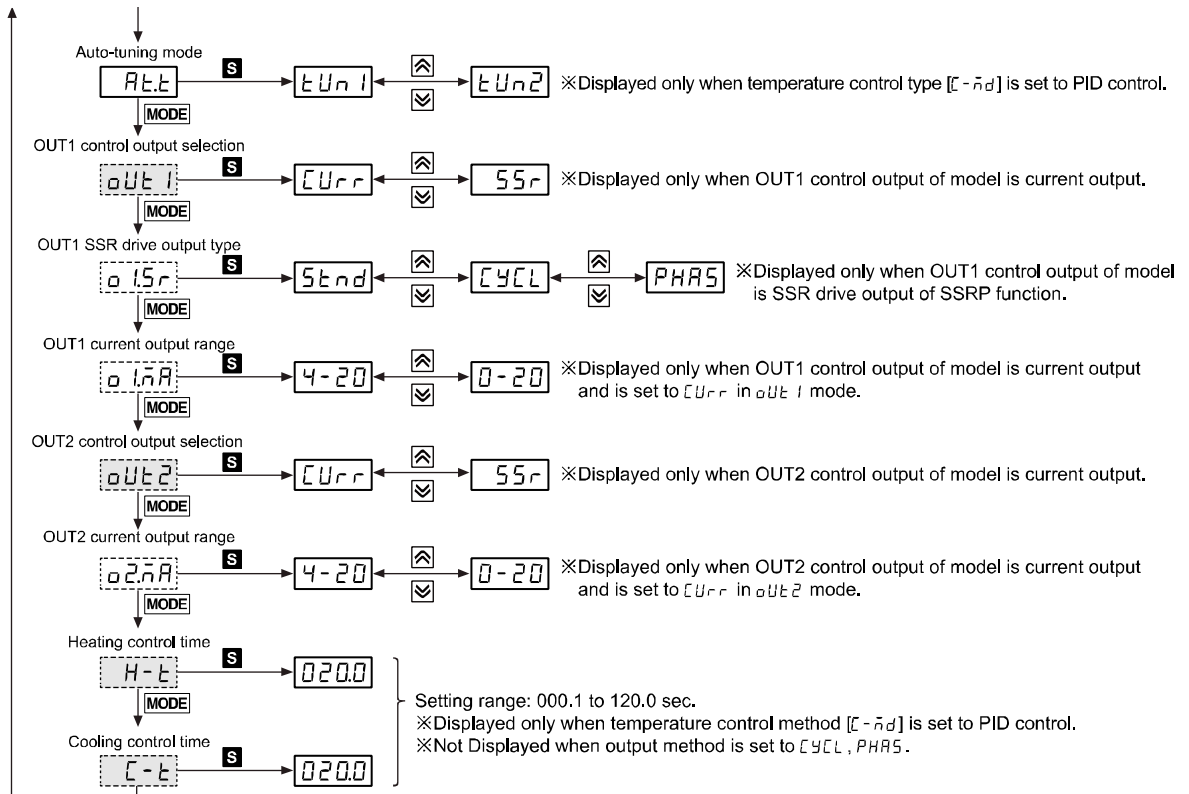

※ OUT1, OUT2 output:

- In case that OUT1, OUT2 output is relay output type
: oUt 1, o 1Sr, o 1nA, oUt 2, o2Sr, o2nA parameters are not displayed.
- In case that OUT1,OUT2 output is current + SSR drive output type, when OUT1,OUT2 output is set to SSr
: Output method of o 1Sr, o2Sr is held in Stnd and parameter is not displayed.
- In case that OUT1, output is SSR drive output model of SSRP function and OUT2 output is current + SSR drive output
-oUt 1,o 1nA are not displayed.
-o 1Sr can set to Stnd, CYCL, PHAS
-When o2Sr is set to SSr it is held in Stnd and parameter is not displayed.

5.4.4 Parameter 4 group [PAR4]

- ※1: **S**: Press any key among \leftarrow , \rightarrow , \uparrow , \downarrow
- ※After entering setting mode, press **MODE** key anytime for 3 sec. to return to Run mode.
- ※After entering setting mode, press **MODE** key anytime for 1.5 sec. to go to the concerned group name.
- ※If you press the **MODE** key after changing the set value of the parameter the set value will be stored.
- ※ Shaded parameters are for standard-level users, the others are for high-level users.
- (You can set the user level in parameter 5 group)
- ※ This parameter might not be displayed depending on other parameter settings.

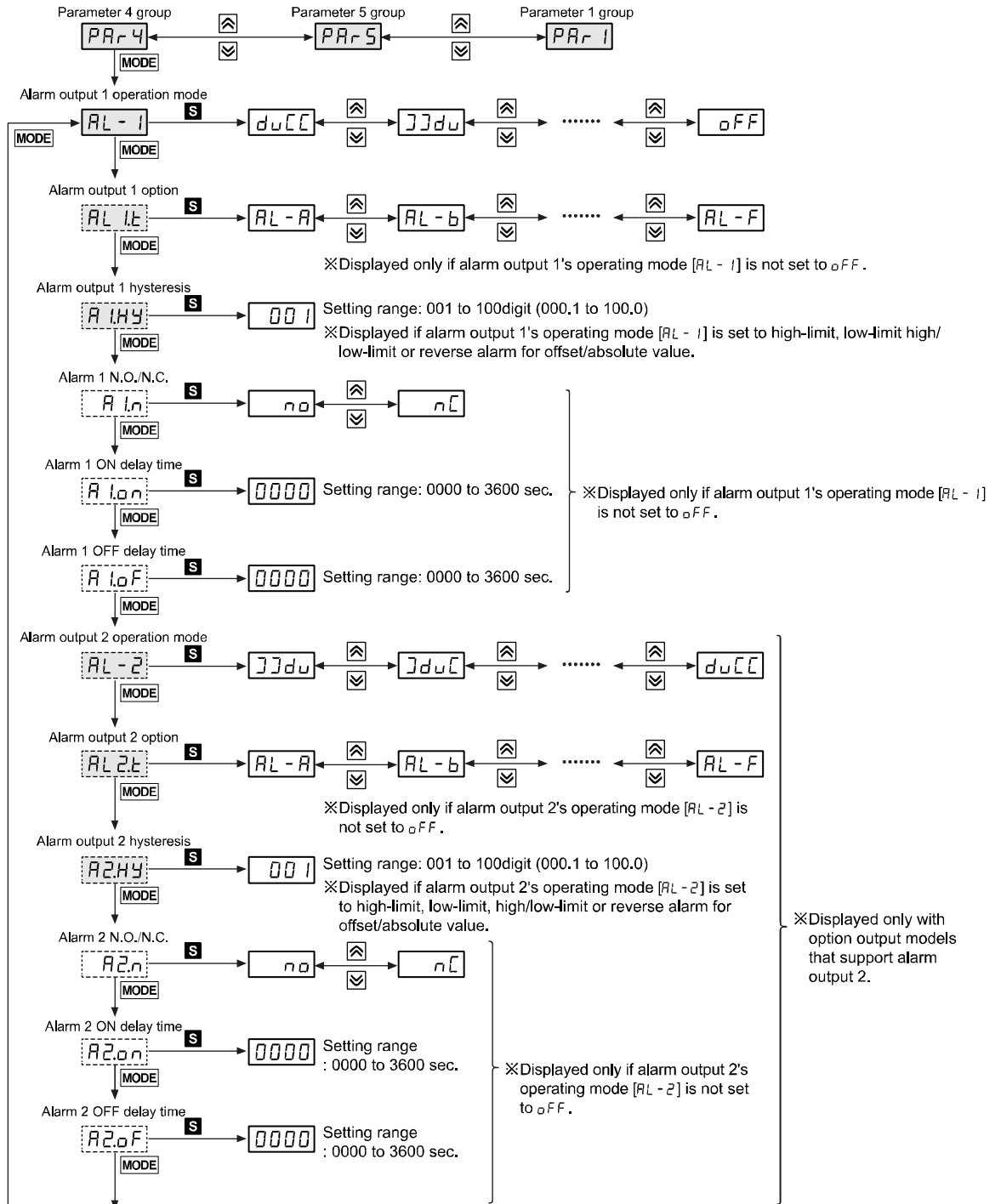

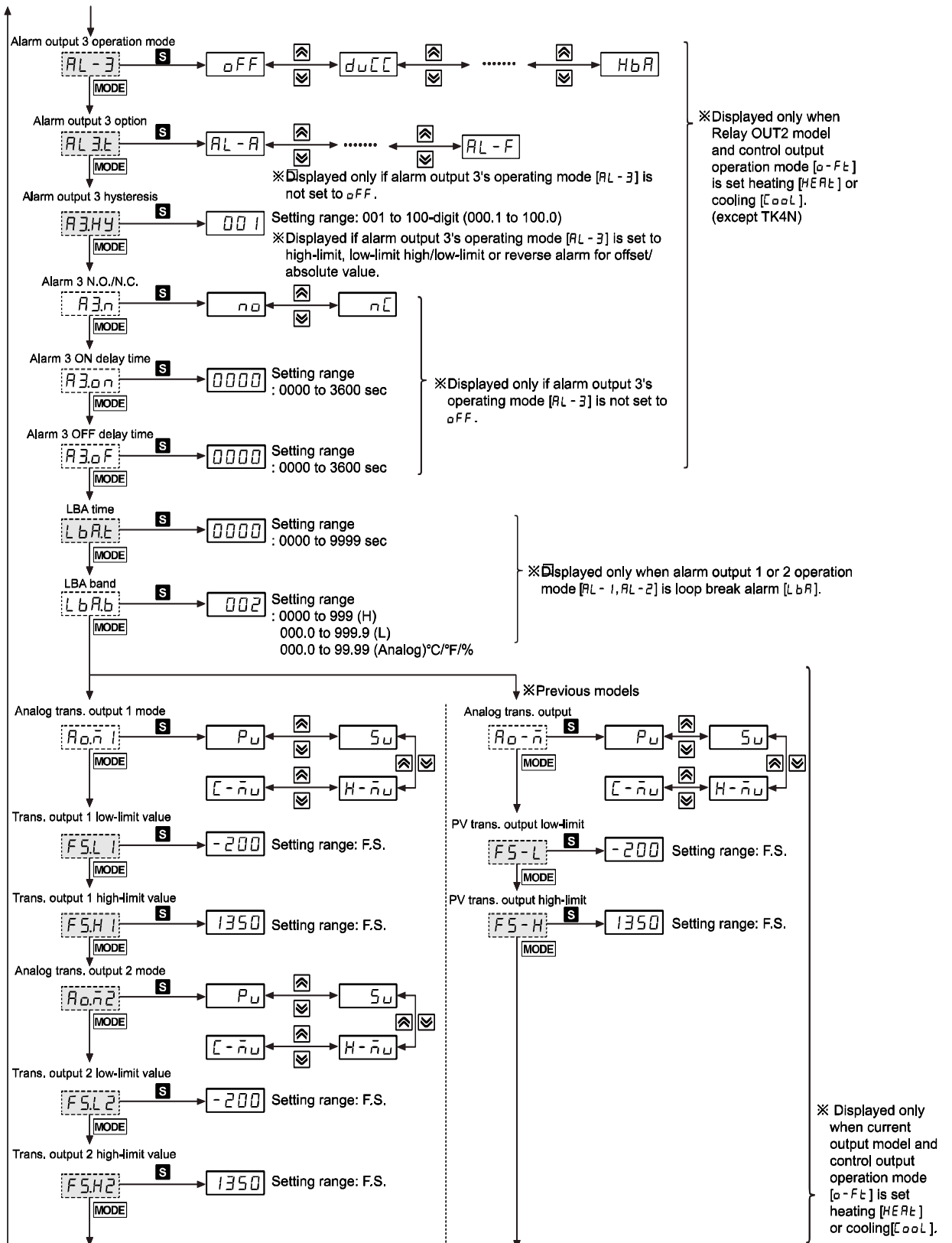

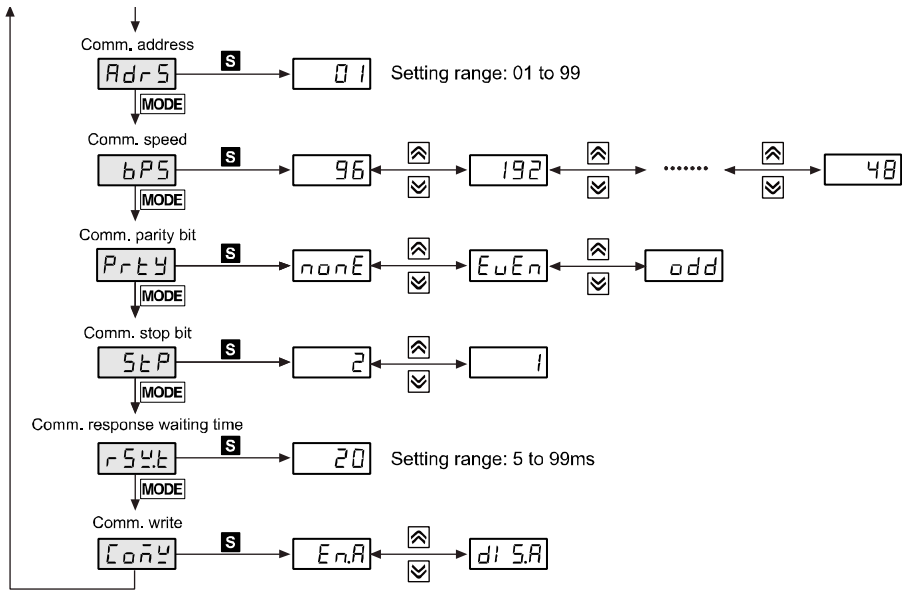

5.4.5 Parameter 5 group [PAR 5]

- ※1: **S**: Press any key among **←**, **→**, **↑**, **↓**
- ※After entering setting mode, press **MODE** key anytime for 3 sec, to return to Run mode.
- ※After entering setting mode, press **MODE** key anytime for 1.5 sec, to go to the concerned group name.
- ※If you press the **MODE** key after changing the set value of the parameter the set value will be stored.
- ※ Shaded parameters are for standard-level users, the others are for high-level users.
(You can set the user level in parameter 5 group)
- ※ This parameter might not be displayed depending on other parameter settings.

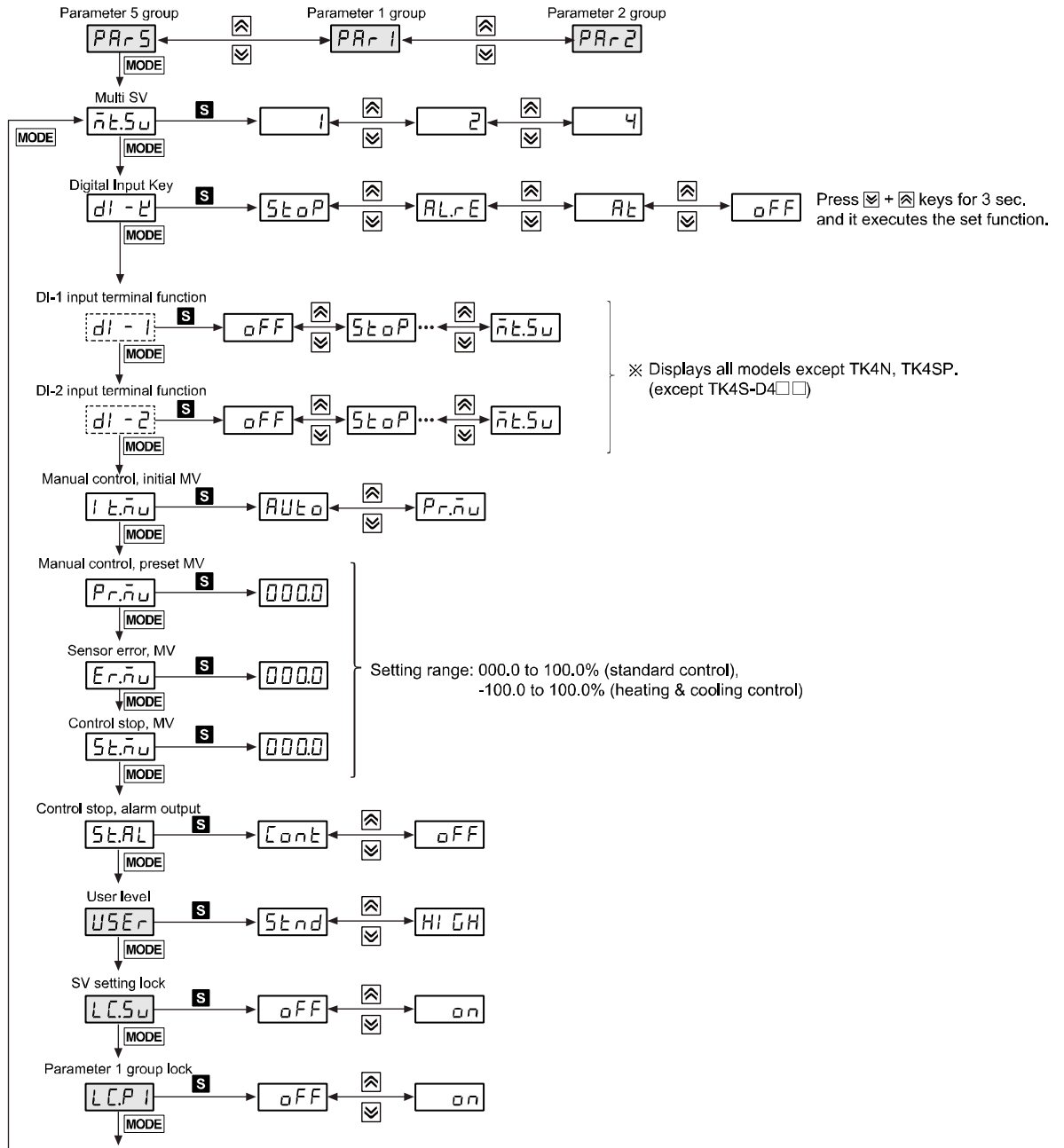

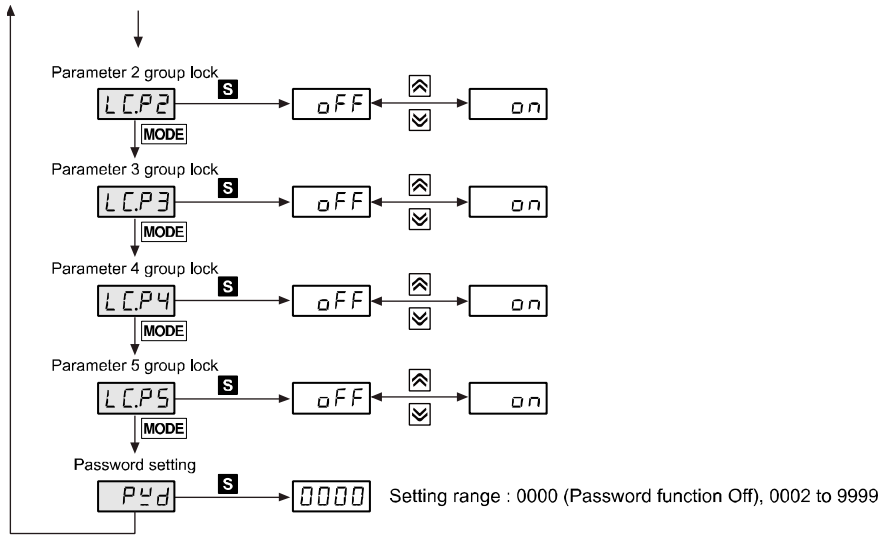

6 Parameter Settings and Functions

6.1 Input

6.1.1 Input types and temperature ranges

Input types			Display	Temperature range (°C)	Temperature range (°F)
Thermocouple (TC)	K (CA)	1	℄℄℄℄	-200 to 1350	-328 to 2463
		0.1	℄℄℄℄	-199.9 to 999.9	-199.9 to 999.9
	J (IC)	1	℄℄℄℄	-200 to 800	-328 to 1472
		0.1	℄℄℄℄	-199.9 to 800.0	-199.9 to 999.9
	E (CR)	1	℄℄℄℄	-200 to 800	-328 to 1472
		0.1	℄℄℄℄	-199.9 to 800.0	-199.9 to 999.9
	T (CC)	1	℄℄℄℄	-200 to 400	-328 to 752
		0.1	℄℄℄℄	-199.9 to 400.0	-199.9 to 752.0
	B (PR)	1	℄ ℄℄	0 to 1800	32 to 3272
	R (PR)	1	℄ ℄℄	0 to 1750	32 to 3182
	S (PR)	1	℄ ℄℄	0 to 1750	32 to 3182
	N (NN)	1	℄ ℄℄	-200 to 1300	-328 to 2372
	C (TT) ^{※1}	1	℄ ℄℄	0 to 2300	32 to 4172
	G (TT) ^{※2}	1	℄ ℄℄	0 to 2300	32 to 4172
	L (IC)	1	℄℄℄℄	-200 to 900	-328 to 1652
		0.1	℄℄℄℄	-199.9 to 900.0	-199.9 to 999.9
U (CC)	1	℄℄℄℄	-200 to 400	-328 to 752	
	0.1	℄℄℄℄	-199.9 to 400.0	-199.9 to 752.0	
Platinel II	1	℄℄℄℄	0 to 1390	32 to 2534	
RTD	Cu 50Ω	0.1	℄ ℄℄	-199.9 to 200.0	-199.9 to 392.0
	Cu 100Ω	0.1	℄ ℄℄	-199.9 to 200.0	-199.9 to 392.0
	JPt 100Ω	1	℄℄℄℄	-200 to 650	-328 to 1202
	JPt 100Ω	0.1	℄℄℄℄	-199.9 to 650.0	-199.9 to 999.9
	DPt 50Ω	0.1	℄℄℄℄	-199.9 to 600.0	-199.9 to 999.9
	DPt 100Ω	1	℄℄℄℄	-200 to 650	-328 to 1202
	DPt 100Ω	0.1	℄℄℄℄	-199.9 to 650.0	-199.9 to 999.9

Input types			Display	Temperature range (°C)	Temperature range (°F)
	Nickel 120Ω	1	<i>n i 12</i>	-80 to 200	-112 to 392
Analog	Voltage	0 to 10V	<i>R u 1</i>	-1999 to 9999 (Display point will be changed according to decimal point position)	
		0 to 5V	<i>R u 2</i>		
		1 to 5V	<i>R u 3</i>		
		0 to 100mV	<i>R ñ u 1</i>		
	Current	0 to 20mA	<i>R ñ R 1</i>		
		4 to 20mA	<i>R ñ R 2</i>		

※1. C (TT): Same temperature sensor as former W5 (TT).

※2. G(TT): Same temperature sensor as former W (TT).



Note

Temperature sensors are to convert subject temperature to electrical signals for the temperature controller allowing it to control output.

SV (Setting Value) can only be set within the input range and do not set over the input range.

6.1.2 Input type [*PAr3* → *Input*]

This product supports multiple input types, making it possible for the user to choose from thermocouples, resistors, and analog voltage/current.

If you change the input specification, the SV's upper/low-limits are automatically set to the new specification's max/min values for temperature sensors. As for analog inputs, analog upper/lower input values are set to the max/min temperature range and the SV upper/low-limits set to upper/lower scale values. Therefore, you need to reconfigure the settings.

Setting group	Parameter	Setting range	Factory default	Unit
<i>PAr3</i>	<i>Input</i>	Refer to 6.1.1. Input types and temperature	<i>TCRH</i>	-

6.1.3 Sensor temperature unit [*PAr3* → *Unit*]

When selecting the input temperature sensor, you can set the desired units (°C, °F) of temperature/scale value to be displayed.

Setting group	Parameter	Setting range	Factory default	Unit
<i>PAr3</i>	<i>Unit</i>	<i>°C / °F</i>	<i>°C</i>	-



Note

This parameter will not be displayed if analog input has been selected.

6.1.4 Analog input/scale value

With analog input selected, you can set the analog input range (high/low limit input values) and the display scale (high/low limit scale values) within the designated input range.

The decimal point positions remain fixed when configuring the high/low limit input values. You can change the input values at $PA1$: 00.00, $PA2/PA3$: 0.000, $PA4$: 000.0, $PA11/PA12$: 00.00 decimal points.

If the upper and lower limit scale settings are identical, Err flashes twice and setting mode is displayed.

For analog input, $\pm 5\%$ of the set high/low limit input value is extended. Analog output is also extended comparing input value. (For temperature sensor input, $\pm 5\%$ extension is applied within the temperature range.)

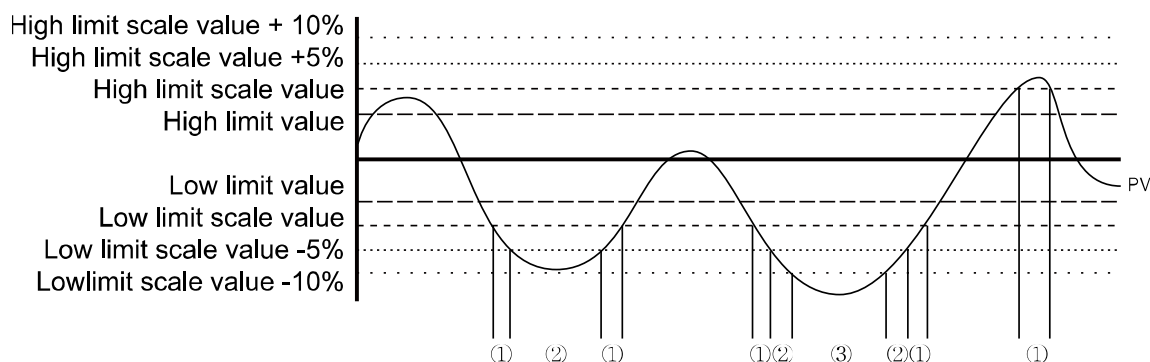

No.	PV	Display
①	$\pm 5\%$ section	Flashes PV
②	± 5 to 10% section	Flashes HHHH or LLLL
③	Over $\pm 10\%$ section	Flashes $\square PEn$



Note

This parameter is not displayed for temperature sensor input.

6.1.4.1 Low-limit input value [$PA3 \rightarrow L-rG$]

You can set the low limit input values for actual use within the analog input range.

Setting group	Parameter	Setting range	Factory default	Unit
$PA3$	$L-rG$	Minimum temperature range to high-limit input value [$H-rG$] - F.S. 10%	00.00	-

6.1.4.2 High-limit input value [$PA3 \rightarrow H-rG$]

You can set high limit input values for actual use within the analog input range.

Setting group	Parameter	Setting range	Factory default	Unit
$PA3$	$H-rG$	Low-limit input value [$L-rG$] + F.S. 10% to maximum temperature range	10.00	-

6.1.4.3 Scale decimal point position [PAR3 → dot]

You can set the decimal point positions for present value (PV) and set value (SV) within high and low limit scale values.

Setting group	Parameter	Setting range	Factory default	Unit
PAR3	dot	0 / 0.0 / 0.00 / 0.000	0.0	-

6.1.4.4 Low-limit scale value [PAR3 → L-SC]

You can set the display scales of low-limit values for analog input [L-rC]. (Based on the decimal point position setting.)

Setting group	Parameter	Setting range	Factory default	Unit
PAR3	L-SC	-9999 to 9999	0000	-

6.1.4.5 High-limit scale value [PAR3 → H-SC]

You can set the display scales of high-limit values for analog input [H-rC]. (Based on the decimal point position setting.)

Setting group	Parameter	Setting range	Factory default	Unit
PAR3	H-SC	-9999 to 9999	1000	-

6.1.4.6 Display unit for front panel [PAR3 → dUnit]

When you select an analog input type, you can set the display units.

Setting group	Parameter	Setting range	Factory default	Unit
PAR3	dUnit	0C / 0F / 0% / 0FF	0%	-

Setting	Parameter description
0C	Sets the display unit to °C and turns on the °C of front unit indicator.
0F	Sets the display unit to °F and turns on the °F of front unit indicator.
0%	Sets the display unit to % and turns on the % of front unit indicator.
0FF	Sets the display unit to an undefined unit. The LED unit indicator will not turn on.

6.1.5 Input correction [PAR3 → I n - b]

This feature is used to compensate for input correction produced by thermocouples, RTDs, or analog input devices, NOT by the controller itself.

The Input correction function is mainly used when the sensor cannot be attached directly to controlled objects. It is also used to compensate for temperature variance between the sensor's installation point and the actual measuring point.

Setting group	Parameter	Setting range	Factory default	Unit
PAR3	I n - b	-999 to 0999 (temperature H, analog)	0000	°C/°F/-
		-99.9 to 999.9 (temperature L)		



Ex.

If the controller displays 78°C when the actual temperature is 80°C, set the input correction [I n - b] as '002' in order to adjust the controller's display temperature to 80°C.

If present value after input correction is out of the input range by each input sensor, it displays 'HHHH' or 'LLLL'.



Note

Make sure that an accurate temperature variance measurement is taken before set values of input correction. An inaccurate initial measurement can lead to greater variance.

Many of today's temperature sensors are graded by their sensitivity. Since higher accuracy usually comes at a higher cost, most people tend to choose sensors with medium sensitivity. Measuring each sensor's sensitivity correction for input correction feature in order to ensure higher accuracy in temperature reading.

6.1.6 Input digital filter [PAR3 → n R u F]

It is not possible to perform stable control if the present value (PV) fluctuates because of fast changes of input signal. Using the Input digital Filter function can stabilize PV to realize more reliable control.

Setting group	Parameter	Setting range	Factory default	Unit
PAR3	n R u F	000.1 to 120.0	0.1	Sec



Ex.

If the input digital filter is set to 0.4 sec., digital filtering is applied to a sampling value collected over 0.4 sec. (400 ms).



Note

When the input digital filter is used, present value (PV) can vary from the actual input value.

6.1.7 High/Low-limit value of setting value(SV) [PAR3 → H-5u/L-5u]

You can limit the Set value(SV) range within the temperature range of the temperature sensor or analog input type in order to prevent the system from controlling with improper SV.

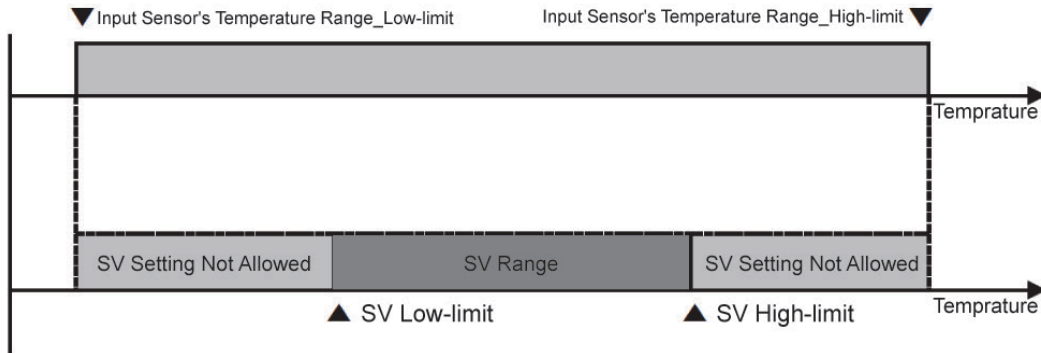

Setting group	Parameter	Setting range	Factory default	Unit
PAR3	H-5u	SV low-limit + 1 digit to sensor input high-limit or analog high-limit scale value	1350 (temperature) 0000 (analog)	°C/°F
	L-5u	Sensor low-limit or analog low-limit scale value to SV high-limit - 1 digit	-200 (temperature) 1000 (analog)	

Parameter	Parameter Description
L-5u	Set value(SV) low-limit
H-5u	Set value(SV) high-limit



Note

Attempts to set the limits outside the min/max input range, or analog's high/low-limits, are not accepted. Instead, the previous settings are retained.

Set value(SV) can only be set within the SV low-limit [L-5u] and SV high-limit [H-5u] range.

SV lower-limit [L-5u] cannot exceed SV high-limit [H-5u].

6.2 Control output

6.2.1 Control output mode [PAR3 → o-Flt]

- Control output modes for general temperature control include heating, cooling, and heating & cooling.
- Heating control and cooling control are mutually opposing operations with inverse outputs.
- The PID time constant varies based on the controlled objects during PID control.

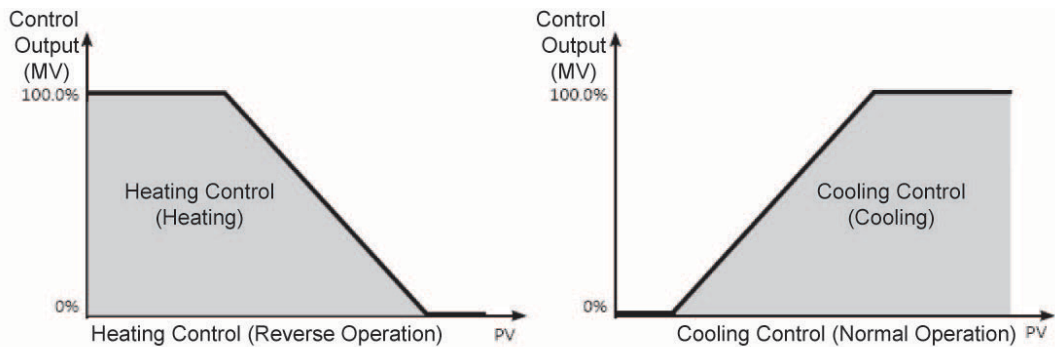

Setting group	Parameter	Set range	Factory default	Unit
PAR3	o-Flt	Standard model: HEAt / COoL	HEAt	-
		Heating/Cooling model: HEAt / COoL / H-C	H-C	-

6.2.1.1 Heating control [PAR3 → o-Flt → HEAt]

Heating control mode: the output will be provided in order to supply power to the load (heater) if present value (PV) falls below set value(SV).

6.2.1.2 Cooling control [PAR3 → o-Flt → COoL]

Cooling control mode: the output will be provided in order to supply power to the load (cooler) if present value (PV) rises above set value(SV).

6.2.1.3 Heating & Cooling control [PAR3 → o-Flt → H-C]

Heating & Cooling control mode: heating & cooling with a single temperature controller when it is difficult to control subject temperature with only heating or cooling.

Heating & Cooling control mode controls the object using different PID time constants for each heating & Cooling.

It is also possible to set heating & cooling control in both PID control or ON/OFF control mode. Heating/cooling output can be selected among Relay output, SSR drive output and current output depending on model types chosen according to your application environment. (Note that SSR drive output of OUT2 operates standard control.)

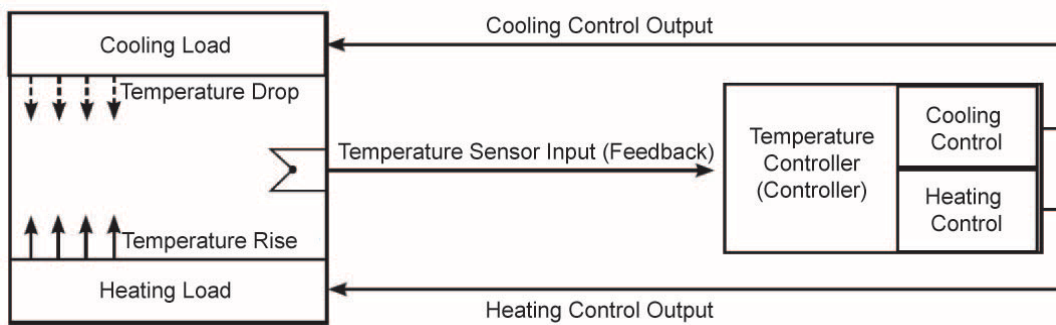

Note

For heating & cooling control, OUT1 control output is dedicated to heating control and OUT2 control output to cooling control.

6.2.1.3.1. Dead band/Overlap band [PAr2 → db]

In heating & cooling control, it is possible to designate a dead band between heating & cooling control bands based on set value(SV).

A dead band forms around the SV when positive (+) value is set. No control occurs in the dead band area. Therefore, heating & cooling MVs become 0.0% in the formed dead band.

An overlap band (simultaneous application of heating & cooling MVs) forms around the SV when negative (-) value is set.

Set as 0 when a dead band or an overlap band is not used.

When setting integration time, it is applied when the integration time of heating control and cooling control is set. In case of PI-P control and P-PI control, it also operates as P-P control.

Setting group	Parameter	Setting range	Factory default	Unit
PAr2	db	See below.	See below.	

- PID/PID, PID/ON-OFF, and ON-OFF/PID Control
 - Set range (temperature): -(proportional band) to +(proportional band) (the lower value when using different proportional bands)
 - Set range (analog): -99.9 to 099.9
 - Factory default: 0000 (temperature H), 000.0 (temperature L, analog), (unit: temperature °C/°F, analog % F.S.)
- ON-OFF/ON-OFF Control
 - Set range (temperature):
 - 999 (overlap band) to 0000 (not used) to 0999 (dead band) (temperature H)
 - 199.9 (overlap band) to 000.0 (not used) to 999.9 (dead band) (temperature L)
 - Set range (analog): -99.9 (overlap band) to 000.0 (not used) to 099.9 (dead band)
 - Factory default: 0000 (temperature H), 000.0 (temperature L, analog), (unit: temperature °C/°F, analog % F.S.)

(1) Using a Deadband

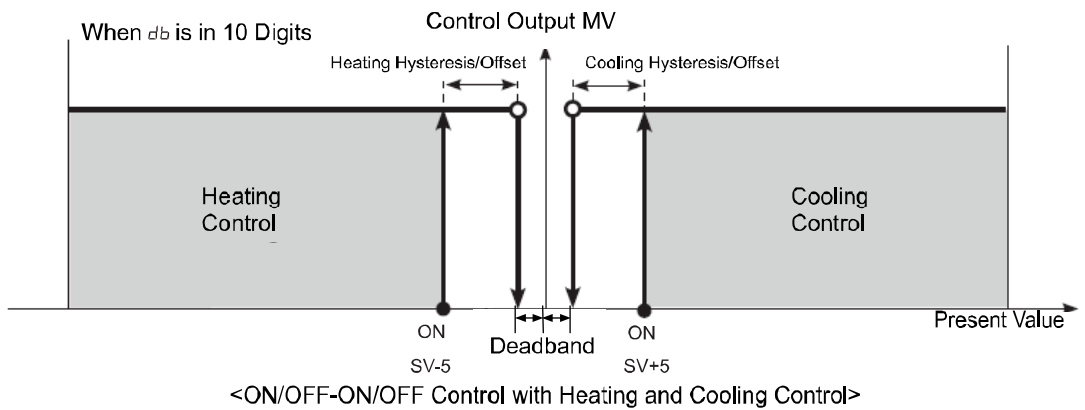
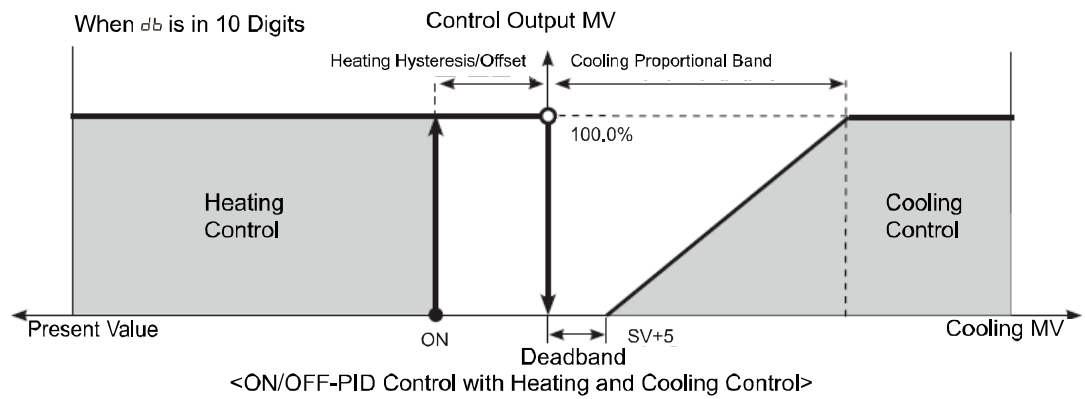
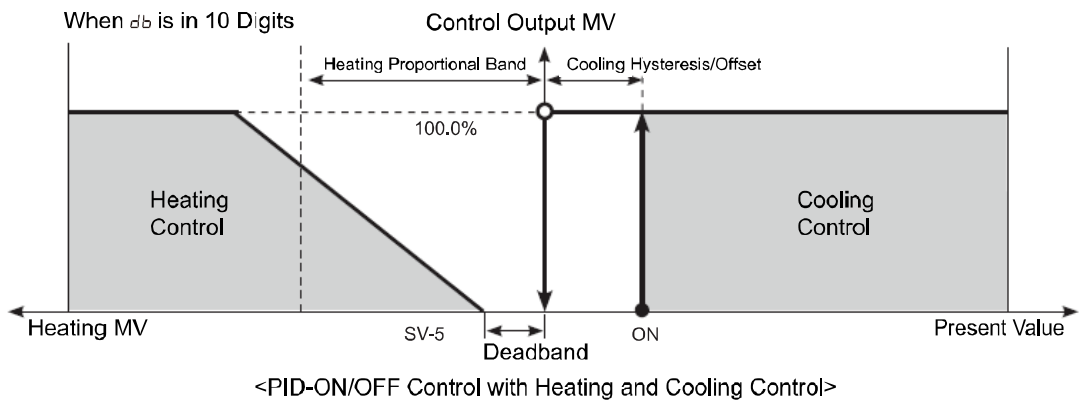
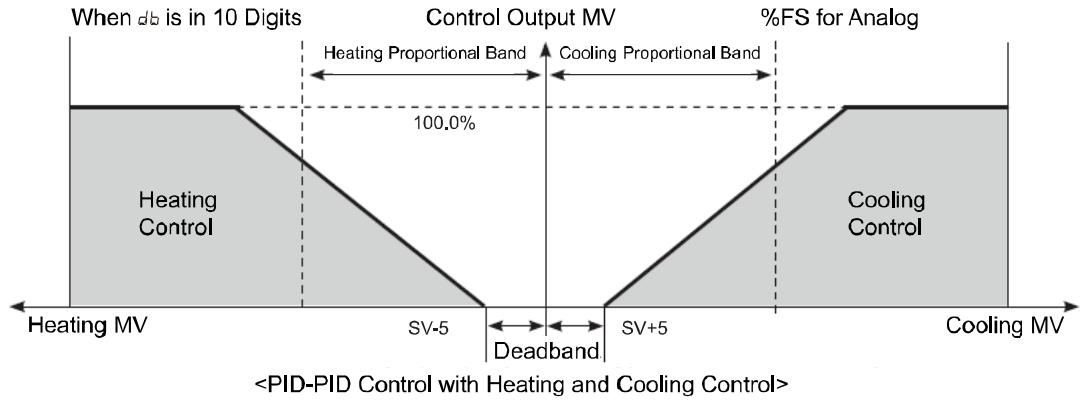

(2) Using an Overlap Band

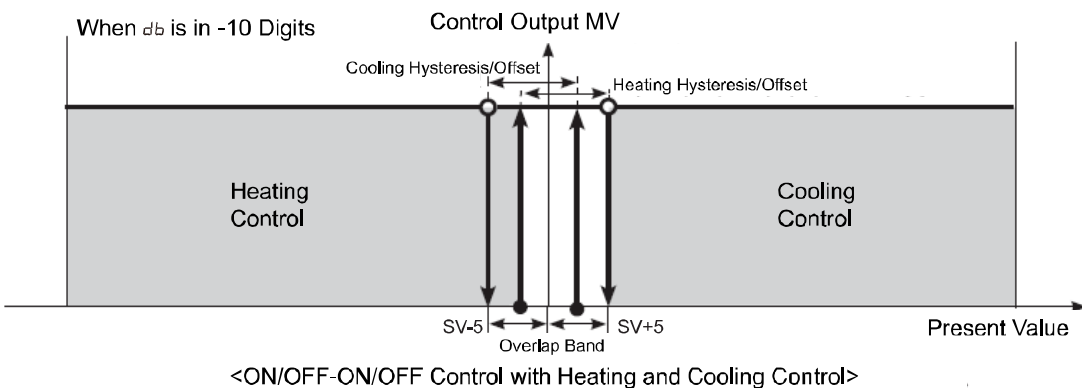
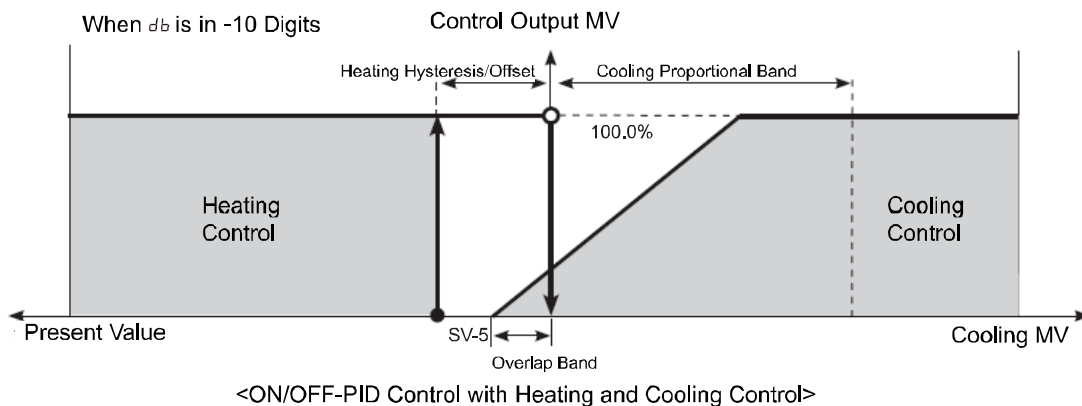
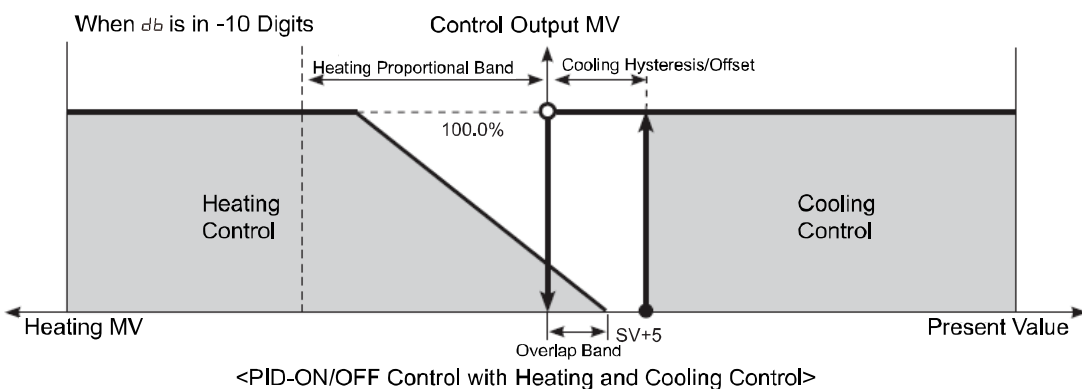
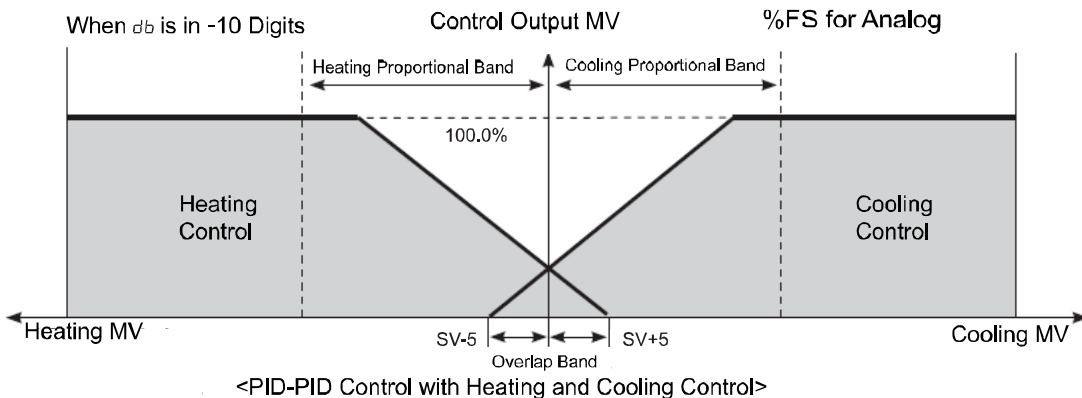

(3) Using neither a Dead band nor an Overlap Band

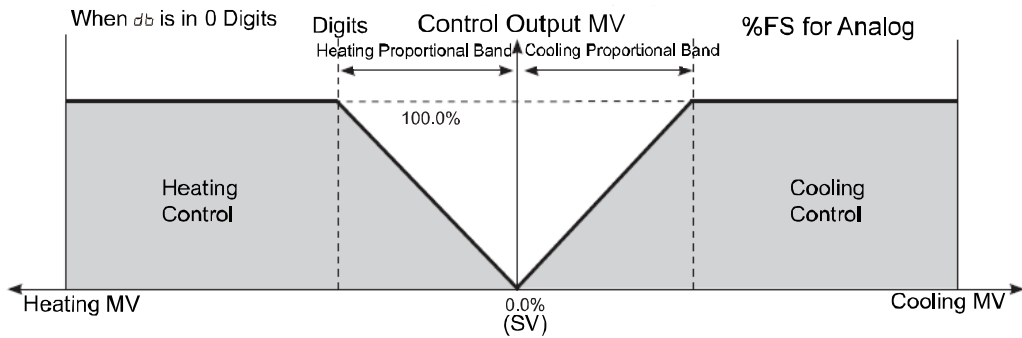

<PID-PID Control with Heating and Cooling Control>

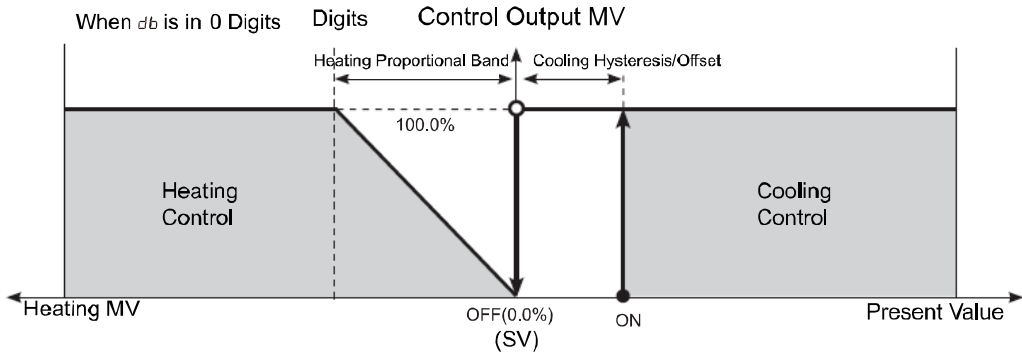

<PID-ON/OFF Control with Heating and Cooling Control>

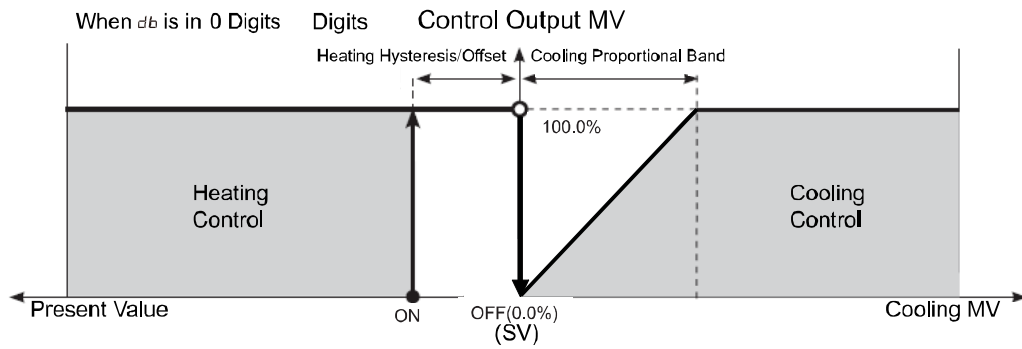

<ON/OFF-PID Control with Heating and Cooling Control>

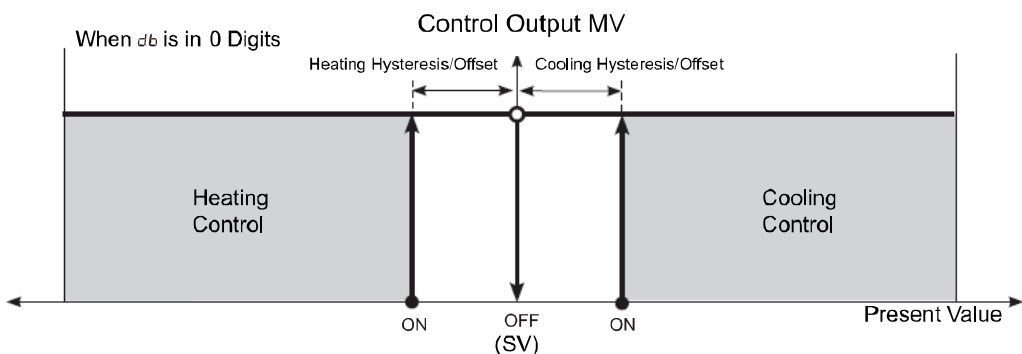

<ON/OFF-ON/OFF Control with Heating and Cooling Control>



Note

Depends on the set value of the heating integration time[H - I], cooling integration time[E - I], actual operation may be different.

6.2.2 MV High/Low-limit value settings [$PAR2 \rightarrow H-\bar{n}_U / L-\bar{n}_U$]

MV high/low-limit values [$H-\bar{n}_U / L-\bar{n}_U$] for control output can be configured to the actual MV, provided the temperature controller's MV calculation exceeds the limits.

During heating & cooling control, cooling MV carries a "-" prefix. Therefore, the high-limit is expressed as a + value on the heating side and the low-limit as a - value on the cooling side.

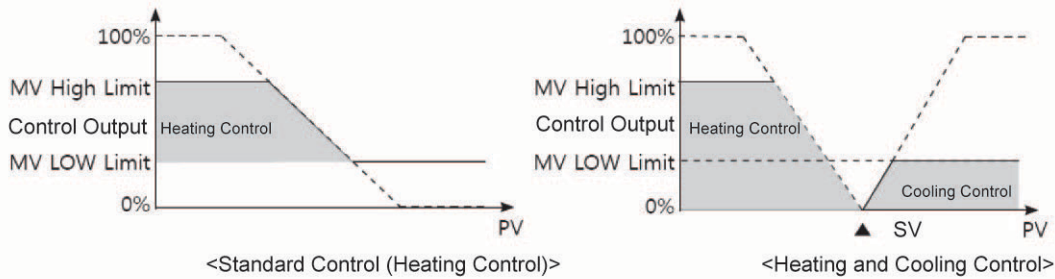

Parameter	Description
$L-\bar{n}_U$	MV Low-limit value setting
$H-\bar{n}_U$	MV High-limit value setting

Setting group	Parameter	Set range	Factory default	Unit
$PAR2$	$H-\bar{n}_U$	Standard Control: MV Low-limit value [$L-\bar{n}_U$] + 0.1 to 100.0	100.0	%
		Heating & Cooling Control: 000.0 to 100.0 (PID control) 0.0 (OFF)/100.0 (ON) (ON/OFF control)	100.0	%
	$L-\bar{n}_U$	Standard Control: 000.0 to MV high-limit value [$H-\bar{n}_U$] - 0.1	0.0	%
		Heating & Cooling Control: -100.0 to 000.0 (PID control), +100.0 (ON)/0.0 (OFF) (ON/OFF control)	-100.0	%



Note

Same MV limits applied during auto-tuning.

MV limits are not applied to manual control, MV upon control stop, MV upon a sensor error, and initial manual control MV.

MV high/low-limit configuration is not available for ON/OFF control in standard control mode (heating or cooling control).

6.2.3 Ramp settings [PAr2 → rAnU / rAnD / rUnt]

Ramp is a feature used to configure the changed temperature per unit time toward set value(SV). The feature limits change rate of set value(SV) and thereby restricts sudden temperature changes (increase and decrease) in the control subject.

Ramp is commonly used in applications where rapid temperature changes (increase and decrease) could impact negatively on the control subject.

Control will be carried out based on changed SV (hereinafter referred to as RAMP SV) - changed by preset change rate (changed temperature per unit time). RAMP-Up Change Rate and RAMP-Down Change Rate can be configured independently.

Parameter	Description
rAnU	Settings for Ramp-up change rate.
rAnD	Settings for Ramp-down change rate.
rUnt	Settings for Ramp unit time.

Setting group	Parameter	Setting range	Factory default	Unit
PAr2	rAnU	000 to 999 (temperature H, analog), 000.0 to 999.9 (temperature L)	000	°C/°F/ Digit
	rAnD	000 to 999 (temperature H, analog), 000.0 to 999.9 (temperature L)	000	°C/°F/ Digit
	rUnt	5EC (seconds), nln (minutes), Hour (hours)	nln	-



Note

Activating the ramp feature when the ramp is not in operation limits the change rate of Set value(SV) based on present value (PV). Changing SV or ramp parameters while the ramp is in operation limits the change rate of SV based on SV at the point of the change.

Alarm operation during RAMP will be made based on final SV.

Setting the rate of ramp change to 0 deactivates the ramp feature.

If the ramp feature has been activated, RAMP SV will be displayed on SV display part.

Ramp depending on operation status

Operation Status	Ramp Up/Down	Ramp
All operations	When it is 0.	Inactive
oPE n, HHHH, LLLL, Auto-tuning, Switching from Auto to Manual, Switching from Run to Stop	Irrespective of conditions.	Inactive
oPE n, HHHH, LLLL, After Auto-tuning completed, PV = SV	Irrespective of conditions.	Inactive
Power On, SV Change, Switching from Stop to Run, Switching from Manual to Auto, Ramp Rate Change	When it is not 0.	Active

Ramp operation graph

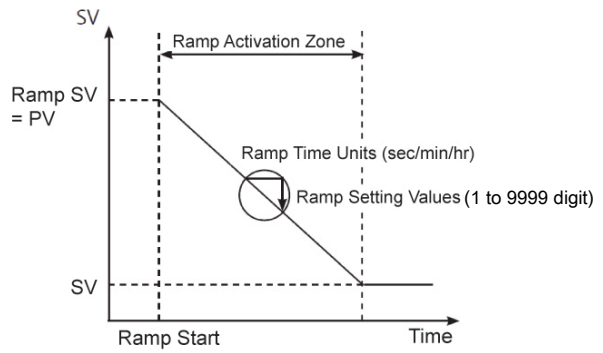
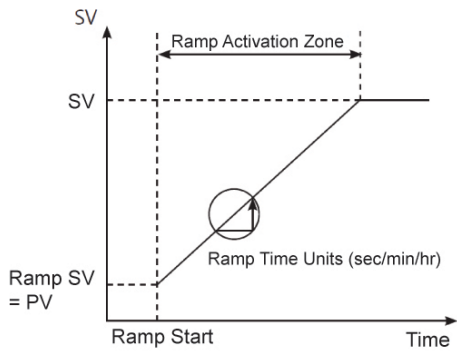

<Activating Ramp when Ramp is not in operation>

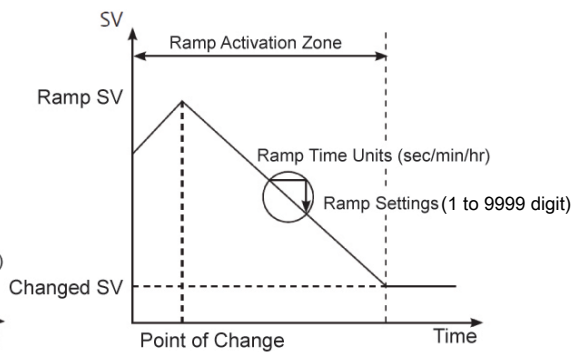
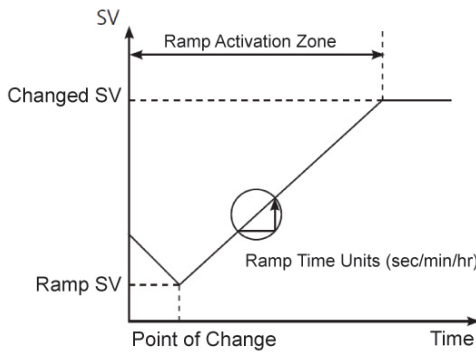

<Changing SV or Ramp Parameter when Ramp is in operation>

6.2.4 Auto/Manual control settings

Auto control mode is to make temperature reach SV with MV calculated by PID control. Manual control mode is to make temperature reach SV with user's defined MV.



Note

When in manual control mode, parameter settings can only be viewed and cannot be modified (except for lock parameters). When digital input terminal function [d1 - 1/d1 - 2] is set as Auto/Manual control [nRn], the $\overline{A/M}$ key (the \overline{MODE} key for TK4N, TK4S, TK4SP) and the Auto/Manual switching by communication do not operate. When the unit is powered on following a power interruption or shutdown, previous control mode (auto or manual) will be maintained.

If switching to manual control during Auto-tuning, Auto-tuning will be terminated. It is still possible to switch to manual control mode while in STOP. When a sensor break alarm [5bR] occurs in standard control mode, the sensor error MV [Er.nw] is applied. In this state, manual and auto control MV settings can be modified. It is still possible to switch auto/manual control mode while in controlling operation.





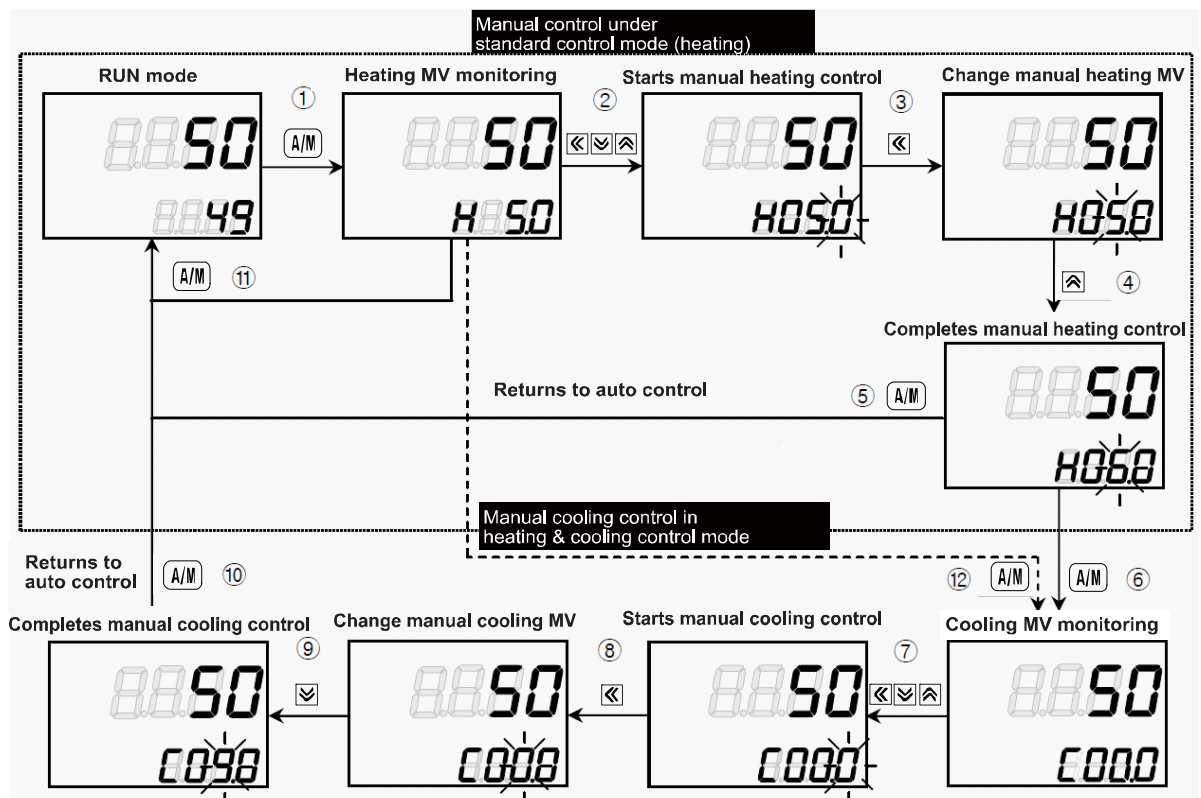

Operation Priority: Manual Control > Stop > Open (Sensor Disconnection)

6.2.4.1 Manual/Auto control switching



























(1) Manual control switching for standard control (heating or cooling control)

- ①, ⑤: When in RUN mode, press the $\overline{A/M}$ key (the \overline{MODE} key for TK4N, TK4S, TK4SP model) and it enters MV monitoring mode. The SV display shows H (heating control) or C (cooling control), and shows MV to indicate the start of MV monitoring.
- ②, ⑥: If the $\overline{\leftarrow \checkmark \rightarrow}$ is pressed when MV monitoring is in progress, the MAN indicator comes on and the lowest digit (10^0 digit) starts to flash, indicating activation of manual control.
- ③, ⑦: Press the $\overline{\leftarrow}$ key to change the flashing digit ($10^0 \rightarrow 10^1 \rightarrow 10^2 \rightarrow 10^3 \rightarrow 10^0$).

- ④, ⑧: Select the digit and configure the desired MV value using the    keys moving to 0→1→2→3→4→5→6→7→8→9→0 by the   keys.
- ⑨: In ① to ⑧ status, press the  key (the  key for TK4N, TK4S, TK4SP model) to end manual control. The MAN indicator goes off and the system reverts to auto control mode.

(2) Manual control switching for heating & cooling control



- ①: When in RUN mode, press the  key (the  key for TK4N, TK4S, TK4SP model) and it enters heating MV monitoring mode. The SV display shows 'H' and shows MV to indicate the start of heating MV monitoring.
- ②: If the    is pressed when heating MV monitoring is in progress, the MAN indicator comes on and the lowest digit (10^0 digit) starts to flash, indicating activation of manual control.
- ③: Press the  key to change the flashing digit ($10^0 \rightarrow 10^1 \rightarrow 10^2 \rightarrow 10^3 \rightarrow 10^0$).
- ④: Select the digit and configure the desired MV value using the    keys moving to 0→1→2→3→4→5→6→7→8→9→0 by the   keys.
- ⑤: In ① to ④ status, press the  key (the  key for N, S, SP model) and it enters cooling MV monitoring mode. The SV display shows 'L' and shows MV to indicate the start of cooling MV monitoring.
- ⑥: If the    is pressed when cooling MV monitoring is in progress, the lowest digit (10^0 digit) starts to flash.
- ⑦: Press the  key to change the flashing digit ($10^0 \rightarrow 10^1 \rightarrow 10^2 \rightarrow 10^3 \rightarrow 10^0$).
- ⑧: Select the digit and configure the desired MV value using the    keys moving to 0→1→2→3→4→5→6→7→8→9→0 by the   keys.
- ⑨: In ⑤ to ⑧ status, press the  key (the  key for TK4N, TK4S, TK4SP model) to end manual control. The MAN indicator goes off and the system reverts to auto control mode.





Note

After heating & cooling control, the system reverts to auto control in sequence of heating monitoring, manual heating control, cooling monitoring, and manual cooling control.

Heating MV remains in effect during cooling monitoring and manual cooling control.

TK4N/S/SP (W48×H48mm) does not have the  key. Press the  key once to change between auto and manual controls.

If the digital input feature [d1 - 1/d1 - 2] has been set for AUTO/MANUAL[$\bar{n}Rn$], the  key (the  key for TK4N, TK4S and TK4SP model) key located on the front and automatic/manual control functions via communication do not act.

(3) Manual/Auto Control switching with the digital input (DI) terminal

If the digital input feature [d1 - 1/d1 - 2] has been set for AUTO/MANUAL control switching[$\bar{n}Rn$], turn on the DI to activate manual control (MAN indicator goes on) and turn off the DI to activate auto control. If the digital Input feature is automatic control status, you can be only to monitor. In case it is manual control status, modifying MV and monitoring are possible.



Note

See 6.7.4 Digital input, for detailed information on digital Input (DI) terminal settings.

When MV parameter is masked, MV parameter cannot be monitored and changed.

6.2.4.2 Baseline MV for manual control [PR5 → I.t.u]

When switching from auto control [AUt0] to manual control [Pr.u] you can set the initial MV.

- AUt0: Controlling with auto control MV as an initial MV for manual control
- Pr.u: Controlling with preset manual MV [Pr.u] as an initial MV.

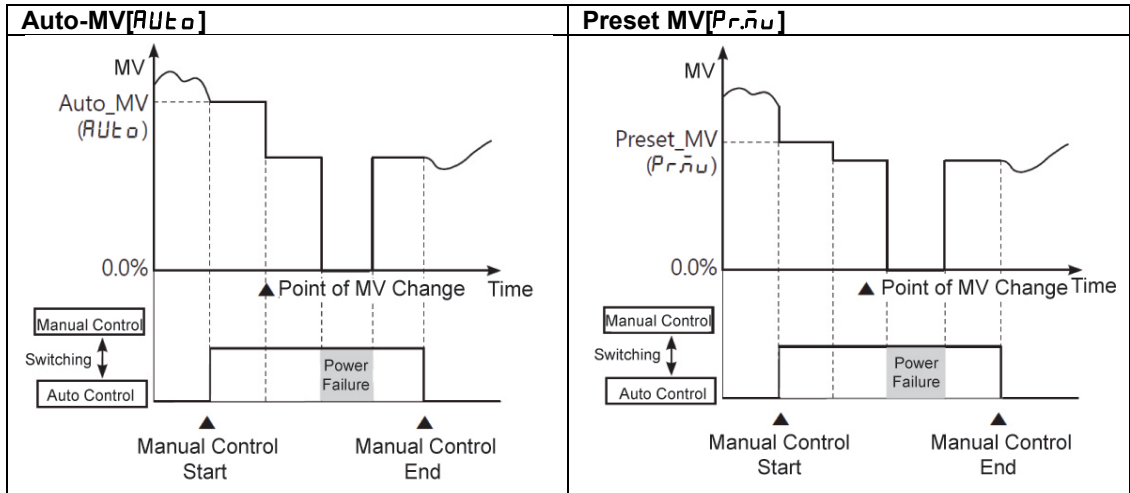

Setting group	Parameter	Setting range	Factory default	Unit
PR5	I.t.u	AUt0 / Pr.u	AUt0	-



Note

When re-supplying the power, it controls with the MV which is at the power OFF.

6.2.4.3 Initial MV for manual control [PR5 → Pr.u]

If the baseline MV for manual control is configured to Pr.u (Preset Manual MV), you can set the initial MV for manual control.

Setting group	Parameter	Setting range		Factory default	Unit	
PR5	Pr.u	Standard control	ON/OFF control	000.0 (OFF) 1100.0 (ON)	000.0	%
			PID control	000.0 to 100.0		
		Heating & Cooling control	ON/OFF control	-100.0 (Cooling ON) 1000.0 (OFF) 1100.0 (Heating ON)		
			PID control	-100.0 (Cooling) to 000.0 (OFF) to 100.0 (Heating)		



Note

When in heating & cooling control mode, a setting between 0.1 and 100.0 will be applied as heating MV and a setting between 0.1 and -100.0 will be applied as cooling MV.

6.2.5 Output settings

6.2.5.1 Control output (OUT1/OUT2) selection [PR3 → OUT1/OUT2]

- In case of selecting the Models with current control output, both current and SSR drive outputs are available. You can therefore choose the right output type depending on application environments.
- *OUT1*: Selects OUT1 control output.
- *OUT2*: Selects OUT2 control output.

Setting group	Parameter	Setting range	Factory default	Unit
PR3	<i>OUT1</i>	55r / CURr	55r	-
	<i>OUT2</i>			

6.2.5.2 SSRP function [PR3 → ISr]

SSRP function of SSR drive output is selectable one of standard ON/OFF control, cycle, phase control. By parameter setting, standard SSR drive is available. Also, cycle control connecting with a zero cross turn-on method SSR, phase control connecting with a random turn-on method SSR are available.

Realizing high accuracy and cost effective temperature control with both current output (4-20mA) and linear output(cycle control and phase control).

(1) Standard ON/OFF control [Stnd]

A mode to control the load in the same way as Relay output type.(ON: output level 100%, OFF: output level 0%)

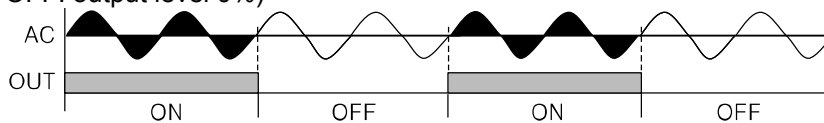

(2) Cycle control [CYCL]

A mode to control the load by repeating output ON / OFF according to the rate of output within setting cycle. Having improved ON / OFF noise feature by Zero Cross type.

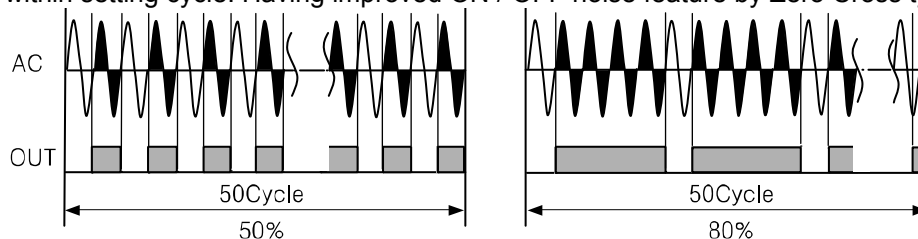

(3) Phase control [PHAS]

A mode to control the load by controlling the phase within AC half cycle. Serial control is available. Random turn-on SSR must be used for this mode.

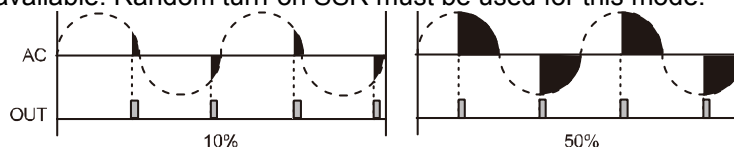

Setting group	Parameter	Setting range	Factory default	Unit
PR3	<i>ISr</i>	Stnd / CYCL / PHAS	Stnd	-

**Note**

- Make sure that SSRP function is not available for OUT2. In case of current type models, SSR is fixed to standard output [5tnd] only.
- When selecting cycle output [CYCL] or phase output [PHAS], the power supply for the load and temperature controllers must be the same.
- In case of selecting SSRP function whether cycle output [CYCL] or phase output [PHAS] with PID control type, control cycle is not available to set.

6.2.5.3 Current output range settings [PAR3 → 01nA/02nA]

If the control output is set to current output, you can select upper and low-limit range for the current output as either 4-20mA or 0-20mA.

- 01nA: Sets OUT1's current output range.
- 02nA: Sets OUT2's current output range.

**Note**

This parameter is only available on models supporting current output [out1, out2].

6.3 Temperature control**6.3.1 Temperature control mode [PAR3 → [-nd]**

You can choose the type of temperature control method.

Setting		Description	
		Heating	Cooling
Standard Control	Pi d	PID control	
	onof	ON/OFF control	
Heating & Cooling Control	P,P	PID control	PID control
	P,on	PID control	ON/OFF control
	on,P	ON/OFF control	PID control
	on,on	ON/OFF control	ON/OFF control

Setting group	Parameter	Setting range		Factory default	Unit
PAR3	[-nd	Standard Control	Pi d / onof	Pi d	-
		Heating & Cooling Control	P,P / P,on / on,P / on,on	P,P	

6.3.2 ON/OFF control [PAR3 → [-nd → onof]

Controls the temperature by comparing present value (PV) with set value(SV) and turning power to the load on or off.

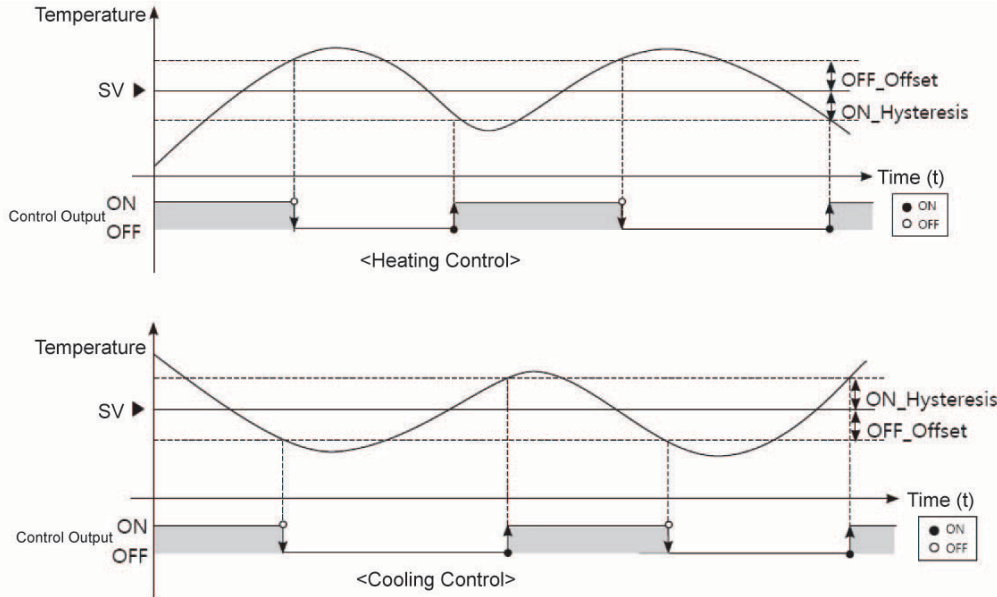

6.3.2.1 Hysteresis [PAR2 → HHYS/HoFt/CHYS/COFt]

Hysteresis is to adjust control output ON/OFF point in ON/OFF control mode. ON_Hysteresis sets the output on point and OFF_Offset sets the off point.

Setting hysteresis too low can result in hunting induced by disturbance (noise, chattering, etc.). To minimize hunting, set ON_Hysteresis and OFF_Offset values with consideration to the heater or cooler's capacity and thermal characteristics, the control subject's response characteristics, the sensor's response characteristics and installation conditions, and other defining factors.

Parameter	Description
HHYS	Configures ON_Hysteresis for heating control.
HoFt	Configures OFF_Offset for heating control.
CHYS	Sets ON_Hysteresis for cooling control.
COFt	Sets OFF_Offset for cooling control.

Setting group	Parameter	Setting range	Factory default	Unit
PAR2	HHYS	Temperature H, Analog: 00.1 to 100	002	°C/°F/-
	CHYS	Temperature L: 00.1 to 100		
	HoFt	Temperature H, Analog: 00.1 to 100	000	
	COFt	Temperature L: 00.1 to 100		

6.3.3 PID control [PAR3 → C-nd → PID]

PID control is a combination of proportional (P), integral (I), and derivative (D) controls and offers superb control over the control subjects, even with a delay time.

Proportional control (P) implements smooth, hunting-free control; integral control (I) automatically corrects offsets; and derivative control (D) speeds up the response to disturbance. Through these actions, PID control realizes ideal temperature control.

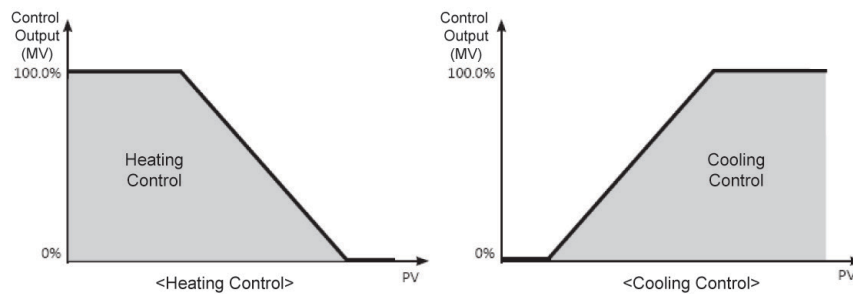

Note

Applied PID Control Technique

- Proportional Control (P): Select PID control and set the integral and derivative time to 0000.
- Proportional Integral Control (PI): Select PID control and set the derivative time to 0000.
- Proportional Derivative Control (PD): Select PID control and set the integral time to 0000.
- Multi SV: Use the same PID time constant for the values of 5.0 to 5.3.

6.3.3.1 Proportional band settings [PAR2 → H-P/C-P]

When present value (PV) is within the Proportional Band (P), the ON/OFF ratio needs to be adjusted during the proportional period (T). The defined proportional control (time proportional control) section is called as the proportional band.

Parameter	Description
H-P	Heating proportional band
C-P	Cooling proportional band

Setting group	Parameter	Setting range	Factory default	Unit
PAR2	H-P	000.1 to 9999	0.100	Temperature: °C/°F Analog: %
	C-P			

6.3.3.2 Integral time settings [PAR2 → H-I/C-I]

MVs from integral and proportional operation become the same when deviation is consistent. The time taken for the two MVs to match is called the integral time.

Parameter	Description
H-I	Heating integral time
C-I	Cooling integral time

Setting group	Parameter	Setting range	Factory default	Unit
PAR2	H-I	0000 to 9999	0000	Sec
	C-I			

**Note**

Integral control is not conducted if the integral time is set to 0.

Setting the integral time too short can intensify correction movements and cause hunting.

6.3.3.3 Derivative time settings [PAR2 → H-d/ℓ-d]

In accordance with the deviation of the ramp, the time taken for the MV gained from derivative operation to reach the MV gained from proportional control is called the derivative time.

Parameter	Description
H-d	Heating derivative time
ℓ-d	Cooling derivative time

Setting group	Parameter	Setting range	Factory default	Unit
PAR2	H-d	0000 to 9999	0000	Sec
	ℓ-d			

**Note**

Derivative control is not conducted if the derivative time is set to 0.

6.3.3.4 Control period settings [PAR3 → H-t/ℓ-t]

If relay or SSR is used to output MV under proportional control, the output is on for a fixed amount of time (within the control period, as a percentage of the MV) and then remains off for the rest of the time. The preset period when output ON/OFF takes place is called the proportional control period.

Control with SSR drive output has a faster response than that of relay output. Therefore, by configuring a shorter control period, more responsive temperature control is achieved.

Parameter	Description
H-t	Heating control period
ℓ-t	Cooling control period

Setting group	Parameter	Setting range	Factory default	Unit
PAR3	H-t	Relay, SSR drive output(ON/OFF control, phase control, cycle control): 000.1 to 120.0 Current output, SSR drive output: 000.1 to 120.0	Relay output: 020.0 SSR drive output: 002.0	Sec
	ℓ-t			

**Note**

If using heating & cooling control, configure each control period separately for heating & cooling.

6.3.3.5 Offset correction/Manual reset settings [PAR2 → rE5t]

When selecting P / PD control mode, there are certain temperature differences even after PV reaches stable status since heater's rising and falling time is inconsistent due to thermal characteristics of control objects, such as heat capacity and the heater capacity. This temperature difference is called OFFSET. Offset can be corrected using manual reset.

Setting group	Parameter	Setting range	Factory default	Unit
PAR2	rE5t	00.0 to 100.0	50.0	%

(1) Manual Reset Adjustments based on Control Results

Under stable control conditions, set the offset to 50% if PV and SV are identical, to over 50.0% if PV is lower than SV, and to below 50.0% if PV is higher than SV.

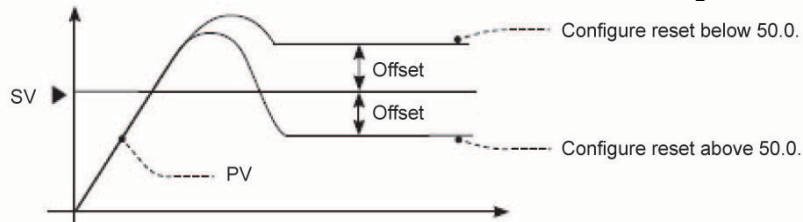

Note

The offset correction feature can only be used when proportional control is in effect. If setting the integral value to 0, the manual reset parameter will be displayed.

The user cannot configure the manual reset setting during heating & cooling control. Instead, the setting is automatically set to 0% for both heating & cooling.

Applicable only when integral time is set to 0 under P control or PD control only.

Switching from heating & cooling control to standard control (P, PD control) automatically configures the reset setting to 50%.

6.3.4 Auto-tuning

Auto tuning measures the control subject's thermal characteristics and thermal response rate, and then determines the necessary PID time constant. (When control type [C - n d] is set as PID, it is displayed.)

If error [oPE n] occurs during auto tuning, it stops this operation automatically.

To stop auto tuning, change the set as oFF. (It maintains P, I, D values of before auto tuning.)

6.3.4.1 Auto-tuning start/stop setting [PAR2 → At]

- Auto-tuning automatically stores PID time constants upon termination. These PID time constants can then be modified by the user to suit their usage environment.
- When auto-tuning is in progress, the AT indicator located on the front of the controller flashes in 1 sec. intervals. When auto-tuning finishes, the AT indicator automatically goes off and the auto-tuning parameter will return to oFF.
- When auto-tuning is in progress and digital input key [di - t] is switching RUN/STOP [St oP] or auto-tuning RUN/STOP [At] is set, and digital input terminal function [di - 1, di - 2] is switching RUN/STOP [St oP] or AUTO/MANUAL control selection [n n n], auto-tuning will be automatically ended, if concerned DI is inputted or a sensor disconnection error occurs. (Restored the PID used prior to the auto-tuning session)

Setting	Description
αFF	Auto-tuning complete.
αn	Auto-tuning in progress.

Setting group	Parameter	Setting range	Factory default	Unit
$PRr2$	Rt	$\alpha FF/\alpha n$	αFF	-



Note

Auto-tuning continues to run even if the temperature reading exceeds or falls below the input range.

When auto-tuning is in progress, parameters can only be referenced and not altered.

Auto-tuning is not available in manual control.

6.3.4.2 Auto-tuning mode settings [$PRr3 \rightarrow Rt.t$]

Auto-tuning is available in [$tUn1$] mode (based on SV) or [$tUn2$] mode (based on 70% of SV), depending on the baseline value used.

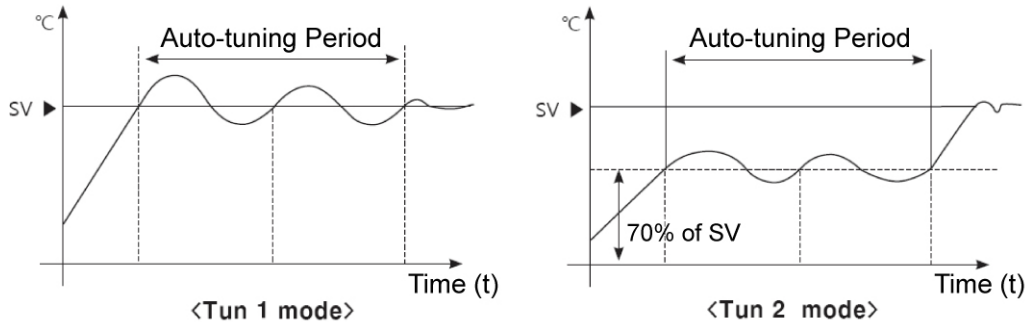

Setting	Description
$tUn1$	Auto-tunes and derives a PID time constant based on set value(SV).
$tUn2$	Auto-tunes and derives a PID time constant based on 70% of set value(SV).

Setting group	Parameter	Setting range	Factory default	Unit
$PRr3$	$Rt.t$	$tUn1/tUn2$	$tUn1$	-



Note

In cooling control mode, [$tUn2$] mode calculates 70% based at 0.

When $SV=-100$, [$tUn2$] is performed at -70.

6.4 Alarm output

There are three alarms which operate individually. You can set combined qoralarm operation and alarm option. Use digital input setting as [AL-E] or turn OFF power and re-start this unit to release alarm operation.

6.4.1 Alarm operation [PAR-4 → AL-1/AL-2/AL-3]

Select the desired alarm operation.

Mode	Name	Alarm operation	Description (factory default)	
OFF	-	-	No alarm output	
duLL	Deviation high-limit alarm	<p>High deviation: Set as 10°C</p>	<p>High deviation: Set as -10°C</p>	If deviation between PV and SV as high limit is higher than set value of deviation temperature, the alarm output will be ON. High-limit deviation temperature can be set in AL 1.H/AL 2.H/AL 3.H.
]]du	Deviation low-limit alarm	<p>Lower deviation: Set as 10°C</p>	<p>Lower deviation: Set as -10°C</p>	If deviation between PV and SV as low limit is higher than set value of deviation temperature, the alarm output will be ON. Low limit can be set in AL 1.L/AL 2.L/AL 3.H.
]]duL	Deviation high/low-limit alarm	<p>Lower deviation: Set as 10°C, High deviation: Set as 20°C</p>		If deviation between PV and SV as high/low limit is higher than set value of deviation temperature, the alarm output will be ON. High-limit Deviation Temperature can be set in AL 1.H/AL 2.H/AL 3.H. Low limit can be set in AL 1.L/AL 2.L/AL 3.H.
[du]]	Deviation high/low-limit reverse alarm	<p>Lower deviation: Set as 10°C, High deviation: Set as 20°C</p>		If deviation between PV and SV as high/low-limit is higher than set value of deviation temperature, the alarm output will be OFF. High-limit deviation can be set in AL 1.H/AL 2.H/AL 3.H. Low limit deviation can be set in AL 1.L/AL 2.L/AL 3.H.
PuLL	Absolute value high limit alarm	<p>Alarm absolute value: Set as 90°C</p>	<p>Alarm absolute value: Set as 110°C</p>	If PV is higher than the absolute value, the output will be ON. Alarm's absolute value can be set in AL 1.H/AL 2.H/AL 3.H.
]]Pu	Absolute value low limit alarm	<p>Alarm absolute value: Set as 90°C</p>	<p>Alarm absolute value: Set as 110°C</p>	If PV is lower than the absolute value, the output will be ON. Alarm's absolute value can be set in AL 1.L/AL 2.L/AL 3.H.
LbA	Loop break alarm	-	It will be ON when it detects loop break.	

Mode	Name	Alarm operation	Description (factory default)
<i>SbA</i>	Sensor break alarm	-	It will be ON when it detects sensor disconnection.
<i>HbA</i>	Heater break alarm	-	It will be ON when CT detects heater break.

※H: Alarm output hysteresis [*A* *.HY*]

Parameter	Description
<i>AL-1</i>	Selects alarm output 1 operation mode.
<i>AL-2</i>	Selects alarm output 2 operation mode.
<i>AL-3</i>	Selects alarm output 3 operation mode.

Setting group	Parameter	Setting range	Factory default	Unit
<i>PAR4</i>	<i>AL-1</i>	<i>oFF / du[[]]du /]du[[du] / Pu[[]]Pu / SbA / LbA / HbA</i>	<i>du[[</i>	-
	<i>AL-2</i>		<i>]]du</i>	
	<i>AL-3</i>		<i>oFF</i>	

6.4.2 Alarm output options [PR4 → AL1t/AL2t]

Users can select the desired alarm output options.

Setting	Mode	Description
AL-A	Standard Alarm	If it is an alarm condition, alarm output is ON. If it is a clear alarm condition, alarm output is OFF.
AL-b	Alarm latch ※ ¹	If it is an alarm condition, alarm output is ON and maintains ON status.
AL-C	Standby sequence1※ ²	First alarm condition is ignored and from second alarm condition, standard alarm operates. When power is supplied and it is an alarm condition, this first alarm condition is ignored and from the second alarm condition, standard alarm operates.
AL-d	Alarm latch and standby sequence1	If it is an alarm condition, it operates both alarm latch and standby sequence. When power is supplied and it is an alarm condition, this first alarm condition is ignored and from the second alarm condition, alarm latch operates.
AL-E	Standby sequence2	First alarm condition is ignored and from second alarm condition, standard alarm operates. When re-applied standby sequence and if it is alarm condition, alarm output does not turn ON. After clearing alarm condition, standard alarm operates.
AL-F	Alarm latch and standby sequence2	Basic operation is same as alarm latch and standby sequence1. It operates not only by power ON/OFF, but also alarm set value, or alarm option changing. When re-applied standby sequence and if it is alarm condition, alarm output does not turn ON. After clearing alarm condition, alarm latch operates.

- Condition of re-applied standby sequence for standby sequence 1, alarm latch and standby sequence 1: Power ON
- Condition of re-applied standby sequence for standby sequence 2, alarm latch and standby sequence 2: Power ON, changing set temperature, alarm temperature[AL1, AL2, AL3] or alarm operation[AL-1, AL-2, AL-3], switching STOP mode to RUN mode.

Parameter	Description
AL1t	Selects the operation mode of alarm output 1.
AL2t	Selects the operation mode of alarm output 2.
AL3t	Selects the operation mode of alarm output 3.

Setting group	Parameter	Setting range	Factory default	Unit
PR4	AL1t	AL-A / AL-b / AL-C / AL-d / AL-E / AL-F	AL-A	-
	AL2t			
	AL3t			



Note

If alarm operation is set as loop break alarm [LbA], sensor break alarm [5bA], or heater break alarm[HbA], only standard alarm [AL-A] and alarm latch [AL-C] of alarm option are displayed.

6.4.3 Alarm SV settings [PAR 1 → AL 1L /AL 1H /AL 2L /AL 2H /AL 3L /AL 3H]

You can set alarm output activation values. According to the selected alarm operation, configuration parameters [AL □.H/AL □.L] will be activated for each setting.

Parameter	Description
AL 1L	Low limit value of alarm output 1. Reference value for determining heater burnout.
AL 1H	High-limit value of alarm output 1.
AL 2L	Low limit value of alarm output 2. Reference value for determining heater burnout.
AL 2H	High-limit value of alarm output 2.
AL 3L	Low limit value of alarm output 3. Reference value for determining heater burnout.
AL 3H	High-limit value of alarm output 3.

Setting group	Parameter	Setting range	Factory default	Unit
PAR 1	AL 1H	<ul style="list-style-type: none"> (temperature) High/Low-limit deviation: By individual input specification -F.S. to F.S. (temperature) Alarm absolute value: By individual input specification within displayed range. 	Temperature : 1550 Analog : 1000	-
	AL 2H			
	AL 3H			
	AL 1L	<ul style="list-style-type: none"> (analog) High/Low-limit deviation: -9999 to 9999 Within -F.S. to F.S. (analog) Alarm absolute value: By individual input specification within displayed range. 		
	AL 2L			
	AL 3L			



Note

Changing the alarm operation or options resets the settings to the highest or lowest values that will not trigger output in the new mode.

6.4.4 Alarm output hysteresis [PAR 4 → A 1HY /A 2HY /A 3HY]

"6.4.1 Alarm operation [PAR 4 → AL - 1 /AL - 2 /AL - 3]. "H" from alarm operation represents the alarm output hysteresis. It is used to set an interval between alarm outputs ON/OFF periods.

Hysteresis can be set for individual alarm outputs (Alarm 1 Hysteresis/Alarm2 Hysteresis).

Parameter	Description
A 1HY	Sets the ON/OFF interval for alarm output 1.
A 2HY	Sets the ON/OFF interval for alarm output 2.
A 3HY	Sets the ON/OFF interval for alarm output 3.

Setting group	Parameter	Setting range	Factory default	Unit
PAR 4	A 1HY	Temperature H, Analog: 001 to 100 Temperature L: 000.1 to 1000	001	Temperature: °C/°F, Analog: Digit
	A 2HY			
	A 3HY			

**Note**

Alarm output hysteresis applies to heater burnout alarm [*HbA*] in the same manner.

This parameter does not appear if Loop Break Alarm [*LbA*] or Sensor Break Alarm [*SbA*] is selected.

6.4.5 Alarm N.O./N.C. [*PAR4* → *A1n/A2n/A3n*]

You can set the relay contact method in the event of an alarm output.

Setting	Description
<i>no</i>	Normally open Stays open when normal and closes in the event of an alarm.
<i>nċ</i>	Normally closed Stays closed when normal and opens in the event of an alarm.

Parameter	Description
<i>A1n</i>	Select contact type for alarm output 1.
<i>A2n</i>	Select contact type for alarm output 2.
<i>A3n</i>	Select contact type for alarm output 3.

Setting group	Parameter	Setting range	Factory default	Unit
<i>PAR4</i>	<i>A1n</i>	<i>no / nċ</i>	<i>no</i>	-
	<i>A2n</i>			
	<i>A3n</i>			

Front LED Indicators

Change	Alarm trigger	Alarm output	Front LED
<i>no</i> (normally open)	OFF	Open	<input type="checkbox"/> OFF
	ON	Close	<input checked="" type="checkbox"/> ON
<i>nċ</i> (normally closed)	OFF	Close	<input type="checkbox"/> OFF
	ON	Open	<input checked="" type="checkbox"/> ON

6.4.6 Alarm output delay settings [PR4 → A1on / A1oF / A2on / A2oF / A3on / A3oF]

Alarm output delay can be set to prevent false alarms caused by erroneous input signals resulting from disturbances or noise.

With a preset delay time, alarm output does not turn on for the preset duration. Instead, the concerned alarm indicator on the front will flash in 0.5 sec. intervals.

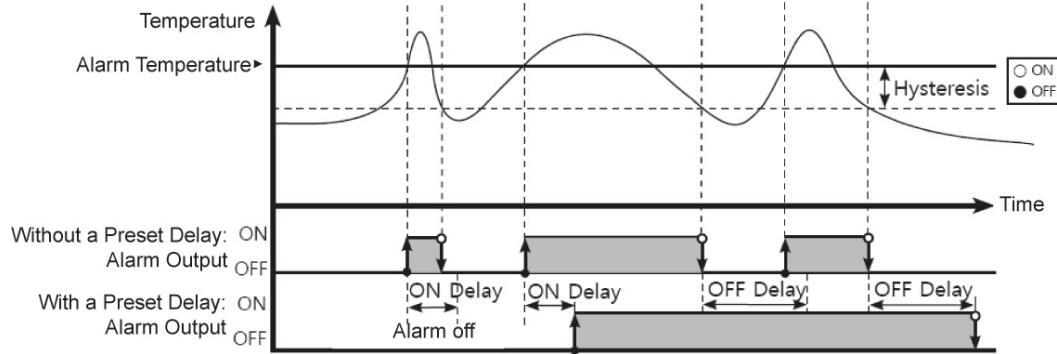

Parameter	Description
A1on	Alarm output 1 on delay: Stands by for the preset duration upon an alarm event, checks the alarm trigger conditions, and turns on the alarm output if the conditions are still present.
A1oF	Alarm output 1 off delay: Stands by for the preset duration following alarm output off, checks the alarm trigger conditions, and turns off the alarm output if the deactivation conditions are still present.
A2on	Alarm output 2 on delay: Stands by for the preset duration upon an alarm event, checks the alarm trigger conditions, and turns on the alarm output if the conditions are still present.
A2oF	Alarm output 2 off delay: Stands by for the preset duration following alarm output off, checks the alarm trigger conditions, and turns off the alarm output if the deactivation conditions are still present.
A3on	Alarm output 3 on delay: Stands by for the preset duration upon an alarm event, checks the alarm trigger conditions, and turns on the alarm output if the conditions are still present.
A3oF	Alarm output 3 off delay: Stands by for the preset duration following alarm output off, checks the alarm trigger conditions, and turns off the alarm output if the deactivation conditions are still present.

Setting group	Parameter	Setting range	Factory default	Unit
PR4	A1on	0000 to 3600	0000	Sec.
	A1oF			
	A2on			
	A2oF			
	A3on			
	A3oF			

6.4.7 Loop break alarm(LBA) [$PAR-4 \rightarrow RL-1/RL-2/RL-3 \rightarrow LbA$]

Diagnoses the control loop by monitoring the control subject's temperature changes and sends out alarms if necessary.

- Heating control: When control output MV is 100% or high limit [$H-\bar{n}_U$] and PV is not increased over than LBA detection band [$LbA.b$] during LBA monitoring time [$LbA.t$], or when control output MV is 0% or low limit [$L-\bar{n}_U$] and PV is not decreased below than LBA detection band [$LbA.b$] during LBA monitoring time [$LbA.t$], alarm output turns ON.
- Cooling control: When control output MV is 0% or low limit [$L-\bar{n}_U$] and PV is not increased over than LBA detection band [$LbA.b$] during LBA monitoring time [$LbA.t$], or when control output MV is 100% or high limit [$H-\bar{n}_U$] and PV is not decreased below than LBA detection band [$LbA.b$] during LBA monitoring time [$LbA.t$], alarm output turns ON.

Common causes of LBA output ON

- Sensor error (disconnection, short)
- External controller error (magnet, auxiliary relay, etc.)
- External load error (heater, cooler, etc.)
- Misconnections and disconnections of external network.

If it is not as sensor break/HHHH/LLLL, during auto-tuning/manual control/control STOP/ramp function operation, loop break alarm does not operate.

Type	LBA monitoring time	Alarm output	
		Standard alarm	Alarm latch
Initializing Alarm, changing control output operation mode, setting LBA monitoring time/band as 0	Initialize	OFF	OFF
Changing input correction value, set value		Maintains the present alarm	Maintains the present alarm
Changing MV, stopping control, running auto-tuning		OFF	Maintains the present alarm
Occurring sensor break alarm, HHHH, LLLL		ON	ON



Note

Set alarm operation[$RL-\square$] as loop break alarm [LbA] and you can use loop break alarm.

When executing auto-tuning, LBA detection band [$LbA.b$] and LBA monitoring time[$LbA.t$] is automatically set based on auto-tuning value.

In case of AT (auto-tuning)/manual control/stop control, loop break alarm [LbA] does not operate. When alarm reset is input, it initializes LBA monitoring start time.

6.4.7.1 LBA monitoring time [PAr4 → LbAt]

You can set the LBA monitoring time to check changes in the control subject's temperature. Automatically setting with auto-tuning.

- Regardless of alarm operation [AL - □] (including LBA monitoring time as "0"), after running auto-tuning, the integration time×2 value is saved automatically.
(If SV is out of the range of auto setting, it is set as max. or min. value of auto setting.)
- Except input type changing, re-running auto-tuning, manual setting of LBA monitoring time, it maintains the present SV.
- Auto setting range: 0020 to 9999

Setting group	Parameter	Setting range	Factory default	Unit
PAr4	LbAt	0000 to 9999	0000	Sec

6.4.7.2 LBA detection band [PAr4 → LbAb]

You can set the minimum value of deviation change to decrease during LBA monitoring time. Automatically setting with auto-tuning.

- Except input type changing, re-running auto-tuning, manual setting of LBA monitoring time, it maintains the present SV.
- Regardless of alarm operation [AL - □] (including LBA monitoring time as "0"), after running auto-tuning, the integration time×2 value is saved automatically.
(If SV is out of the range of auto setting, it is set as max. or min. value of auto setting.)
- Auto setting range
Temperature L: 0020 to 1000 (unit: °C/°F)
Temperature H: 0002 to 0 100 (unit: °C/°F)
Analog: 000.2 to 0 100 (unit: %F.S.)

Setting group	Parameter	Setting range	Factory default	Unit
PAr4	LbAb	Temperature H	000 to 999	002 °C/°F
		Temperature L	000.0 to 999.9	002.0 °C/°F
		Analog	000.0 to 100.0	000.2 %F.S.



Ex.

It checks control loop and outputs alarm by temperature change of the subject.

For heating control(cooling control), when control output MV is 100%(0% for cooling control) and PV is not increased over than LBA detection band [L bR.b] during LBA monitoring time [L bR.t], or when control output MV is 0%(100% for cooling control) and PV is not decreased below than LBA detection band [L bR.b] during LBA monitoring time [L bR.t], alarm output turns ON.

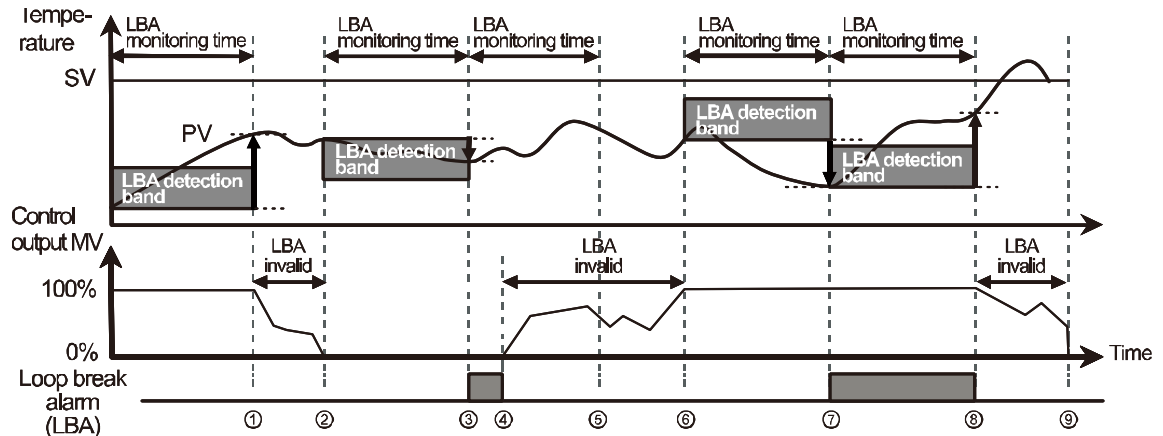

Start to ①	When control output MV is 100%, PV is increased over than LBA detection band [L bR.b] during LBA monitoring time [L bR.t].
① to ②	The status of changing control output MV (LBA monitoring time is reset.)
② to ③	When control output MV is 0% and PV is not decreased below than LBA detection band [L bR.b] during LBA monitoring time [L bR.t], loop break alarm (LBA) turns ON after LBA monitoring time [L bR.t].
③ to ④	Control output MV is 0% and loop break alarm (LBA) turns and maintains ON.
④ to ⑥	The status of changing control output MV (LBA monitoring time is reset.)
⑥ to ⑦	When control output MV is 100% and PV is not increased over than LBA detection band [L bR.b] during LBA monitoring time [L bR.t], loop break alarm (LBA) turns ON after LBA monitoring time [L bR.t].
⑦ to ⑧	When control output MV is 100% and PV is increased over than LBA detection band [L bR.b] during LBA monitoring time [L bR.t], loop break alarm (LBA) turns OFF after LBA monitoring time [L bR.t].
⑧ to ⑨	The status of changing control output MV (LBA monitoring time is reset.)

6.4.8 Sensor break alarm [PR-4 → RL-1/RL-2/RL-3 → 5bA]

You can set the controller to send out an alarm when a sensor is not connected or disconnected during temperature control.

Sensor break can be confirmed through an external alarm output contact, such as a buzzer or similar means.

Setting alarm operation [RL - □] to 5bA will activate Sensor Break Alarm.



Note

Alarm output option can be set to standard LBA alarm [RL - A] or alarm latch [RL - b].

6.4.9 Heater burnout alarm [PAR4 → AL-1/AL-2/AL-3 → HbA]

- When using a heater to raise the temperature of the control subject, the temperature controller can be set to detect heater disconnection and send out an alarm by monitoring power supply to the heater.
- Heater disconnection is detected by the controller using a current transformer (CT), which converts the current to the heater to a specific ratio (CT ratio) for monitoring. If the heater current value [L-A] measured by the CT is less than the heater detection set value [AL□.L], the heater burnout alarm will activate.

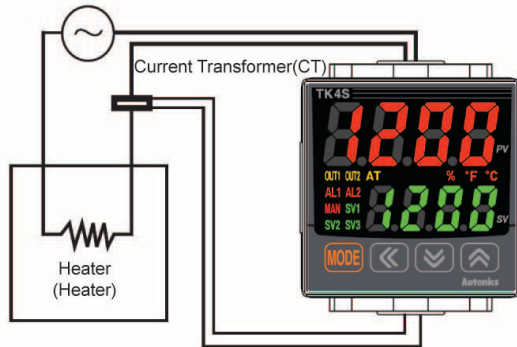

Note

- Heater burnout detection only takes place when the temperature controller's output is turned on. Otherwise, heater burnout will not be detected by the controller.
- Availability of the heater burnout alarm function is different by model and control output type. In case of heating&cooling model, heater burnout alarm function can be used in OUT1.

Model	Control output type	Heater burnout alarm
TK4□-□□R□ (Relay output)	Relay output	○
TK4□-□□S□ (SSR drive output)	ON/OFF control [Stnd]	○
	Cycle control [CYCL]	X
	Phase control [PHAS]	X
TK4□-□□C□ (Current or SSR drive output)	Current output [Curr]	X
	SSR drive output [SSr]	○

- Current detection is not performed if OUT1's control output time is less than 250ms.
- It is recommended to use Autonics designated current transformer (for 50A).
- Alarm output option can be set to standard alarm [AL-A] or alarm latch [AL-b].
- In the case of TK4SP models, heater burnout alarm [HbA] mode is not available.

6.4.9.1 Heater burnout detection settings [PAR 1 → AL 1L / AL 2L / AL 3L]

Set the alarm output value [AL □.L] as the reference value for heater burnout detection.

Setting group	Parameter	Setting range	Factory default	Unit
PAR 1	AL 1L	000 to 500	000	A
	AL 2L			
	AL 3L			



Note

Set to 000 for OFF. Set to 500 for ON.



Ex.

Setting Value Calculation

: Heater Burnout Setting Value = {(Normal Heater Current) + (Heater Burnout Current)}/2

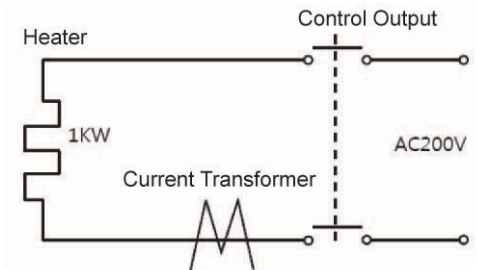

If using a single output heater (Capacity: 200VAC, 1KW, 5A), normal heater current is 5A, and burnout heater current is 0A, the set value is calculated as $(5A + 0A)/2 = 2.5A$. Therefore, heater current values less than 2.5A will be deemed heater burnout and the alarm will activate.

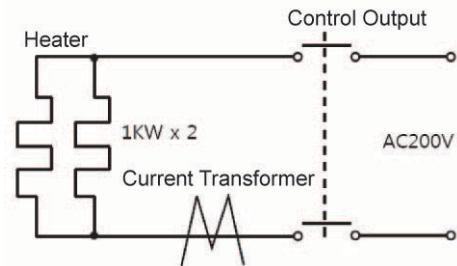



When two output heaters (Capacity: 200VAC, 1KW, 5A) are used, normal heater current is 10A ($5A \times 2$). If a single heater burns out, the heater current becomes 5A. The set value is calculated as $(10A + 5A)/2 = 7.5A$. Heater current values of less than 7.5A are deemed heater burnout and the alarm activates.

6.4.10 Alarm output deactivation [PAR5 → d1 - 1 → ALRE]

Available only if alarm output option is set to alarm latch or alarm latch and standby sequence1, alarm latch and standby sequence2. It can be set to turn OFF alarm output when alarm output is ON, alarm output conditions have been removed, or an alarm output deactivation signal that is greater than the minimal signal band is received. (However, alarm output deactivation is unavailable when alarm conditions remain in effect.)

You can assign the front panel's digital input key [d1 - 1] or the digital input terminals [d1 - 1/d1 - 2] for the alarm output deactivation feature [ALRE]. (regardless of parameter mask)

(1) Deactivating alarm output using digital input key

If the digital input key [d1 - 1] has been assigned for alarm output deactivation [ALRE] and the alarm output option is set to alarm latch or alarm latch and standby sequence, press and hold the front panel's   keys when alarm output is on.

(2) Deactivation of alarm output using digital input (DI) terminal

When the digital input (DI) terminal [d1 - 1/d1 - 2] is assigned to alarm output deactivation [ALRE], the alarm output will deactivate when digital input (DI) terminal goes into the on state (close). (the MAN indicator turns ON).



Note

For detailed information on digital input key settings, see 6.7.4.2 Digital input key.
For detailed information on digital Input (DI) key configuration, see '6.7.4.2 Digital input key'.
For detailed information on digital Input (DI) terminal configuration, see '6.7.4.1 Digital input terminal settings [PAR5 → d1 - 1/d1 - 2]'.

After deactivating the alarm output, it will function normally for the next alarm output occurrence.

6.4.11 Alarm output examples

6.4.11.1 Absolute value high-limit alarm and deviation high-limit alarm

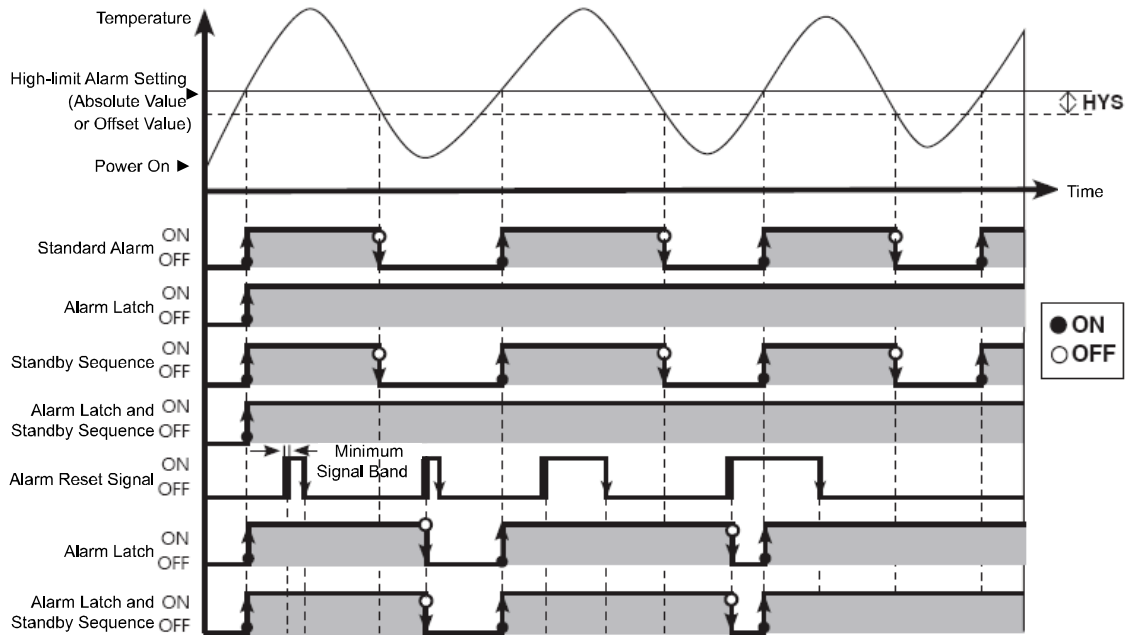

6.4.11.2 Absolute value low-limit alarm and deviation low-limit alarm

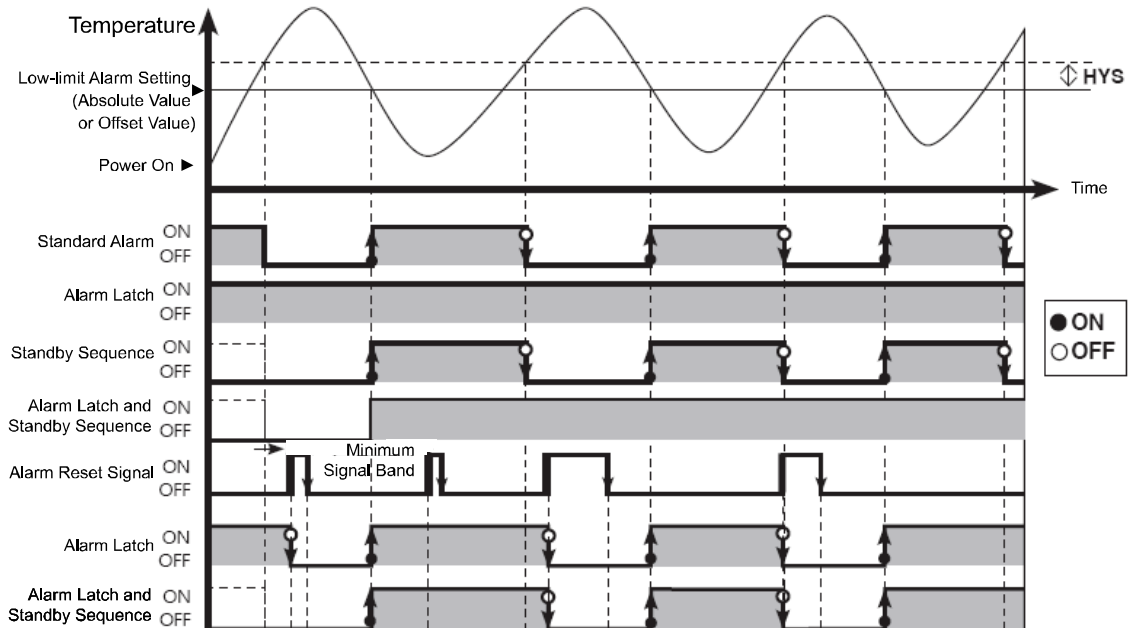

6.4.11.3 Deviation high/low-limit alarm

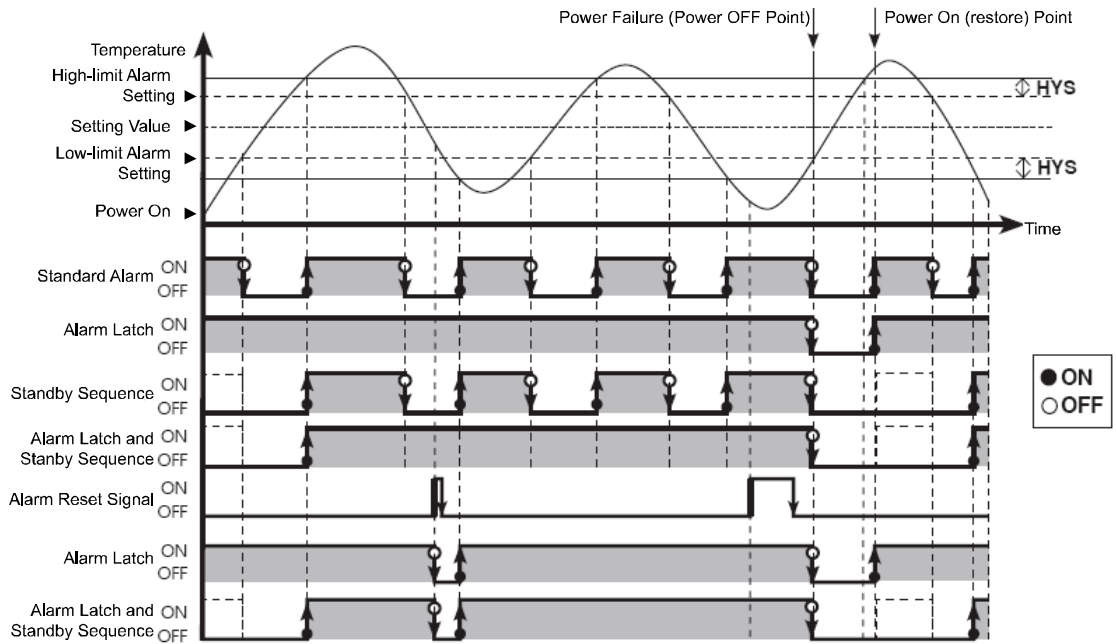

6.4.11.4 Deviation high/low-limit reverse alarm

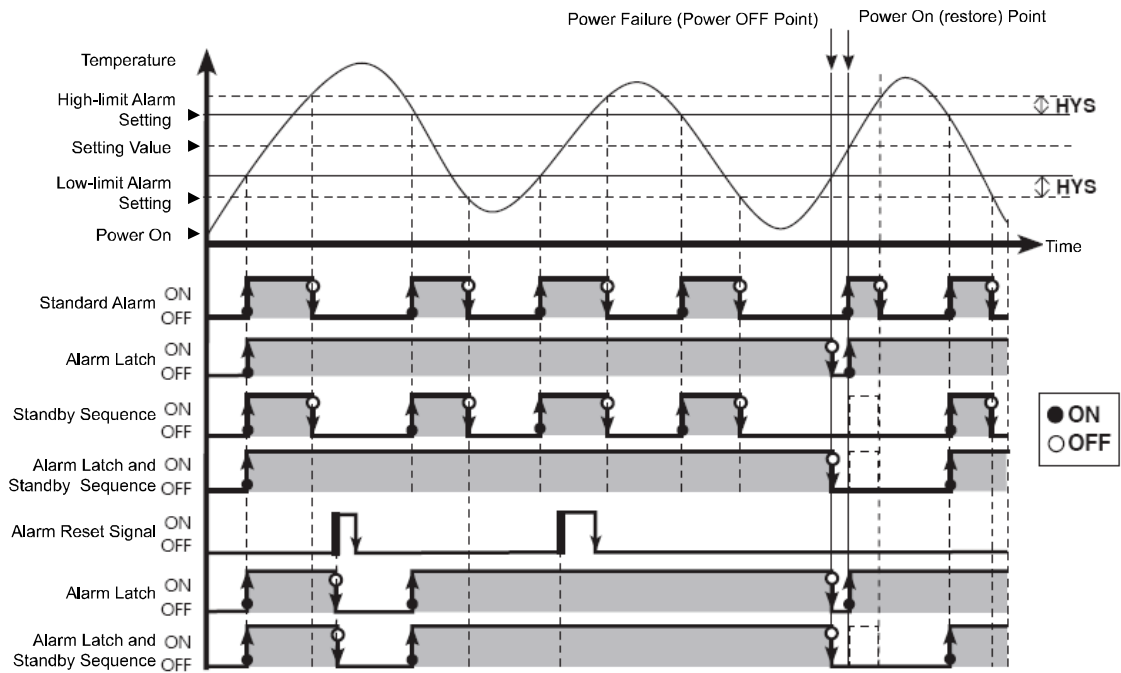

6.4.11.5 Deviation high/low-limit alarm (hysteresis overlap)

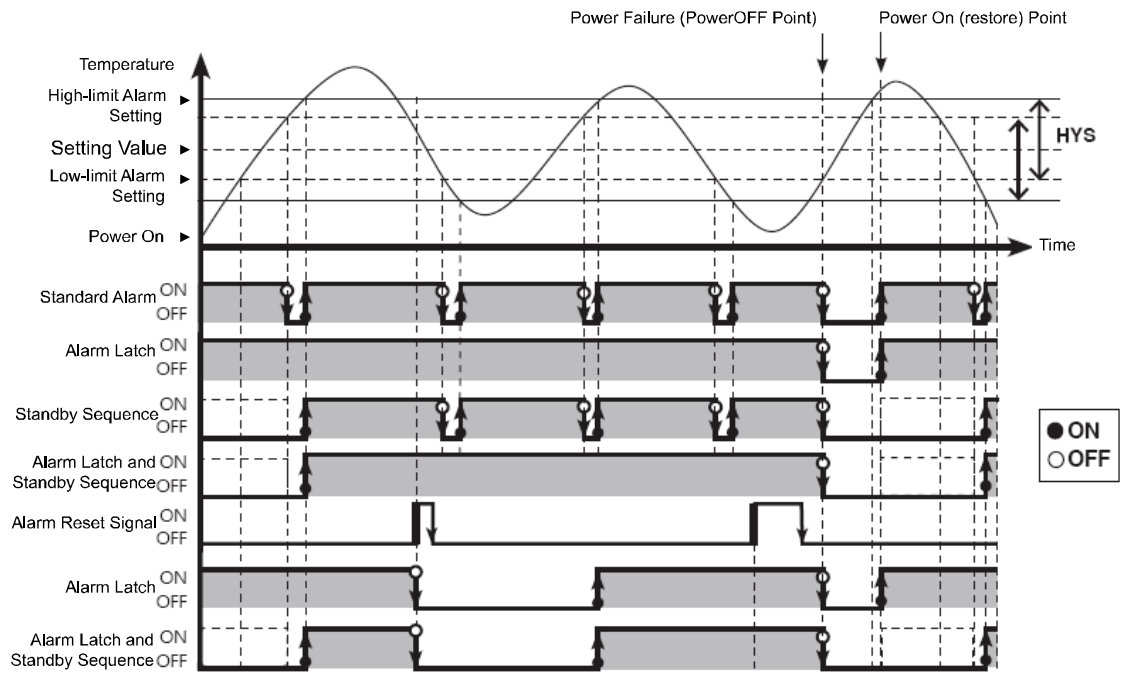

6.5 Analog transmission

6.5.1 Analog transmission output value settings [$PAR4 \rightarrow AON1 / AON2$]

Transmission output is a type of auxiliary output that converts the controller's present value, set value, heating MV, cooling MV to analog current (DC 4 to 20mA) for external transmission.

Setting	Description
P_U	PV transmission output
S_U	SV transmission output
$H-\bar{n}_U$	Heating MV transmission output
$C-\bar{n}_U$	Cooling MV transmission output

Setting group	Parameter	Setting range	Factory default	Unit
$PAR4$	$AON1$	$P_U / S_U / H-\bar{n}_U / C-\bar{n}_U$	P_U	-
	$AON2$			



Note

When using standard control mode of OUT2 current output model, OUT2 current output is available as transmission output 2. For transmission output model, [$AON1$] is activated. For standard control mode of OUT2 current output model, [$AON2$] is activated.

This parameter is activated in transmission output models only. Transmission output is constant current output. Too great a resistance from the load can cause the output value to change. There is no optional output below 4mA or above 20mA.

6.5.2 Transmission output high/low-limit value settings

[$PAR4 \rightarrow F5L1 / F5H1 \rightarrow F5L2 / F5H2$]

If the transmission output value [$AON \square$] is below the transmission output low-limit [$F5L \square$], 4mA output will be provided. If the transmission output is between the low-limit [$F5L \square$] and high-limit [$F5H \square$], a certain proportional output within the range 4mA and 20mA will be provided. If it is above the high-limit [$F5H \square$], 20mA output will be provided.

Setting	Description
$F5L1$	Sets the low-limit of transmission output (4mA).
$F5L2$	
$F5H1$	Sets the high-limit of transmission output (20mA).
$F5H2$	

Setting group	Parameter	Setting range	Factory default	Unit
$PAR4$	$F5L1$ $F5L2$	P_U	Temperature: usage range Analog: high/low scale range	-200
		S_U	SV low-limit value [$L-S_U$] to SV high-limit value [$H-S_U$]	
		$H-\bar{n}_U / C-\bar{n}_U$	000.0 to 100.0	
	$F5H1$ $F5H2$	P_U	Temperature: usage range Analog: high/low scale range	1350
		S_U	SV low-limit value [$L-S_U$] to SV high-limit value [$H-S_U$]	
		$H-\bar{n}_U / C-\bar{n}_U$	000.0 to 100.0	



Note

If transmission output high-limit [F 5.H □] is transmission output low-limit [F 5.L □], the transmission output is 4 mA.

(1) Present value (PV) transmission output

PV within sensor range or upper/low-limit scale can be converted and transmitted as current within the range of 4 to 20 mA.

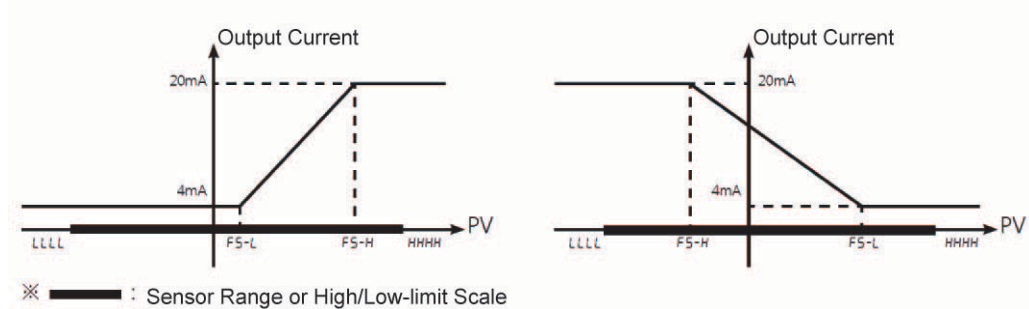

(2) Set value (SV) transmission output

SV within sensor range or upper/low-limit scale can be converted and transmitted as current within the range of 4 to 20 mA. When ramp is in effect, ramp SV is transmitted step by step.

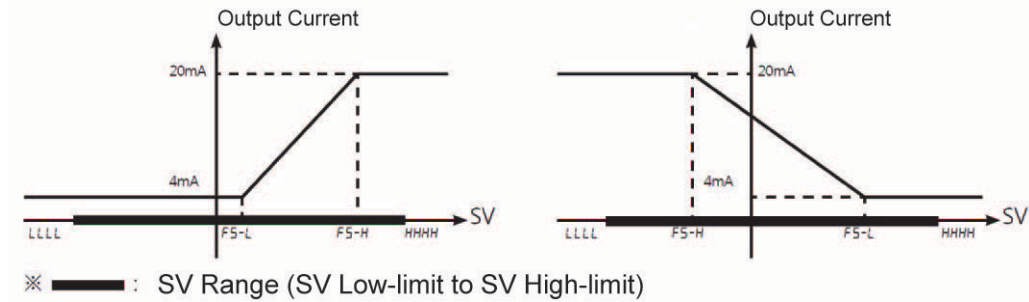

(3) Heating MV/Cooling MV transmission output

You can convert 0 to 100% of heating [H- \bar{n} U]/cooling MV [\bar{L} - \bar{n} U] into 4 to 20 mA current.

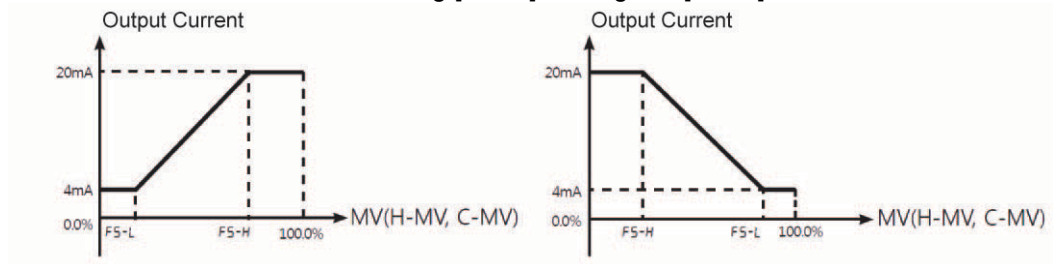

6.6 Communication settings

This feature is used for external higher systems (PC, GP, etc.) to set the controller's parameters and to monitor the controller. It can also be used to transmit data to external devices.

No redundant unit addresses may exist along the same communication line. The communication cable must be a twist pair that supports RS485.

- Interface

Type	Description
Comm. protocol	Modbus RTU
Connection type	RS485
Application standard	Compliance with EIA RS485
Max. connection	31 units (address: 01 to 99)
Synchronous method	Asynchronous
Comm. method	Two-wire half duplex
Comm. distance	Max. 800m
Comm. speed	2400, 4800, 9600, 19200, 38400 bps
Comm. response wait time	5 to 99 ms
Start bit	1-bit (fixed)
Data bit	8-bit (fixed)
Parity bit	None, Odd, Even
Stop bit	1-bit, 2-bit



Note

You could modify the parameter (first in, first out) using keys during communication connection, but this may lead to errors and malfunctions.

6.6.1 Unit address settings [*PAR 4* → *ADR 5*]

You can assign individual addresses to data units.

Setting group	Parameter	Setting range	Factory default	Unit
<i>PAR 4</i>	<i>ADR 5</i>	01 to 99	01	-

6.6.2 BPS (bits per second) settings [*PAR 4* → *bPS*]

You can set the rate of data transmission.

Setting group	Parameter	Setting range	Factory default	Unit
<i>PAR 4</i>	<i>bPS</i>	24(2400 bps) / 48(4800 bps) / 96(9600 bps) / 192(19200 bps) / 384(38400 bps)	96	bps

6.6.3 Communication parity bit [PAR4 → PRtY]

Parity bit is a data communication method that adds an additional bit to each character in transmitted data as an indicator used to verify data loss and corruption. This parameter is used to enable or disable the parity bit option.

Setting	Description
<i>nonE</i>	Disables parity bit.
<i>EuEn</i>	Sets the total bits with signal value of 1 as even numbers.
<i>odd</i>	Sets the total bits with signal value of 1 as odd numbers.

Setting group	Parameter	Setting range	Factory default	Unit
<i>PAR4</i>	<i>PRtY</i>	<i>nonE / EuEn / odd</i>	<i>nonE</i>	-

6.6.4 Communication stop bit settings [PAR4 → StP]

You can set the number of bits to mark the end of a transmitted data string.

Setting	Description
<i>1</i>	Sets end of data string to 1 bit.
<i>2</i>	Sets end of data string to 2 bits.

Setting group	Parameter	Setting range	Factory default	Unit
<i>PAR4</i>	<i>StP</i>	<i>1 / 2</i>	<i>2</i>	bit

6.6.5 Response wait time settings [PAR4 → rStt]

Set a standby time to mitigate communication errors when communicating with a slow master device (PC, PLC, etc.). Once a standby time is set, the controller will respond after the defined standby time.

Setting group	Parameter	Setting range	Factory default	Unit
<i>PAR4</i>	<i>rStt</i>	<i>05 to 99</i>	<i>20</i>	ms



Note

Shorter standby times can cause communication errors in the master device.

6.6.6 Enable/Disable communication write[$PAR4 \rightarrow [ON]$]

This feature can change parameter settings stored in memory through communication with PC, GP, PLC, etc., in order to permit or prohibit writing.

Setting	Description
EnA	Parameter set/change enable via communication.
$diSA$	Prohibit parameter setting or modification via communication.

Setting group	Parameter	Setting range	Factory default	Unit
$PAR4$	$[ON]$	$EnA / diSA$	EnA	-



Note

Reading parameter settings is available even though prohibit parameter setting.

6.6.7 USB to Serial communication connection

Data can be transmitted via a USB-to-serial connection. However, RS485 communication through a USB-to-serial connection is blocked by hardware.

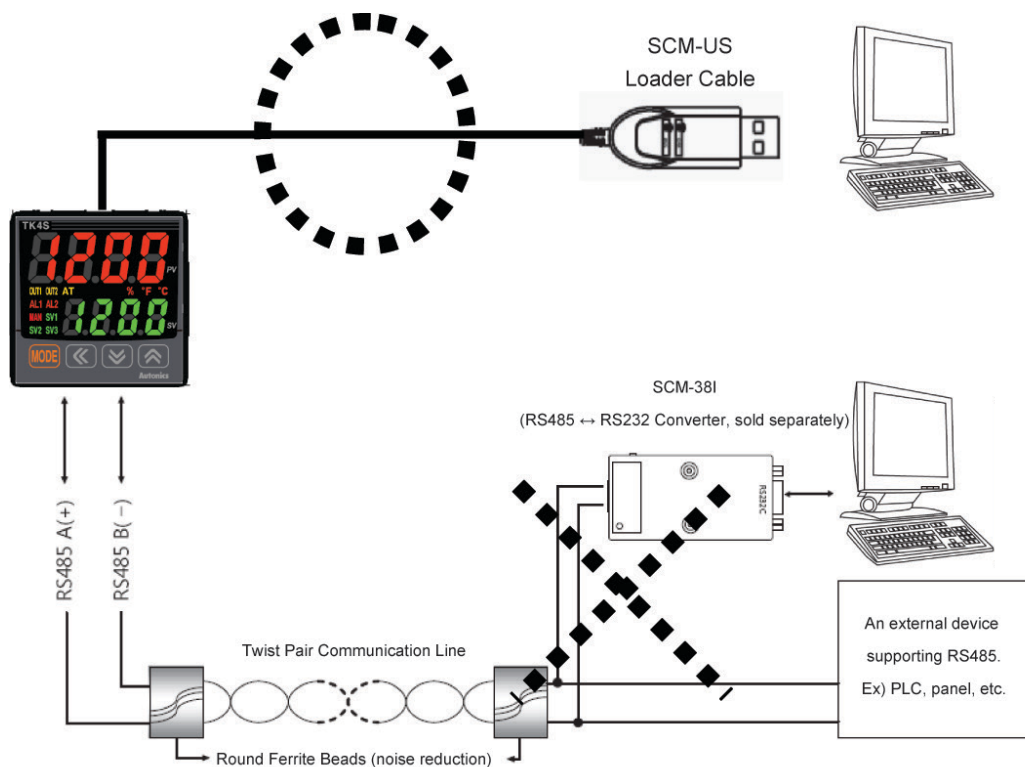

6.7 Additional features

6.7.1 Monitoring

Refer to '5.2.3 MV monitoring and manual control'.

6.7.1.1 Control output MV monitoring

Monitors and displays the current control output MV.

6.7.1.1.1. Heating MV monitoring

Displays the current heating MV during heating control or heating & cooling control. Users may manually adjust the MV to control the temperature.

- Measurement range: $H\ 0.0$ to $H\ 100$ (Unit: %)



Note

Capable of displaying MV with a moving decimal point ($H99.9 \rightarrow H\ 100$).

6.7.1.1.2. Cooling MV monitoring

Displays the current cooling MV during cooling control or heating & cooling control. Users may manually adjust the MV to control the temperature.

- Measurement Range: $C\ 0.0$ to $C\ 100$ (Unit: %)



Note

Capable of displaying MV with a moving decimal point ($C99.9 \rightarrow C\ 100$).

6.7.1.2 Heater current monitoring [PAr 1 → [Ct-A]

A feature that monitors and displays the current of a heater (load) being controlled by control output.

Setting Group	Parameter	Measurement range	Unit
PAr 1	[Ct-A	00 to 500	A



Note



A current transformer (CT) is used to measure and display the heater's (load) current.

Availability of the heater current monitoring function is different by model and control output type. In case of heating&cooling model, heater current monitoring function can be used in OUT1.

Model	Control output type	Heater current monitoring
TK4□-□□R□ (Relay output)	Relay output	○
TK4□-□□S□ (SSR drive output)	ON/OFF control [5tnd]	○
	Cycle control [CYCL]	X
	Phase control [PHAS]	X
TK4□-□□C□ (Current or SSR drive output)	Current output [CURr]	X
	SSR drive output [SSr]	○

6.7.2 RUN/STOP [PAR1 → r-5]

Users may run or stop control output by force while in RUN mode.

The stop command stops control output. Auxiliary output, however, is not affected by the command. This feature can be enabled by configuring parameters. In addition, the front panel's digital input keys (  for 3 sec.) and digital input terminals (DI-1 and DI-2) can be assigned to the run/stop feature[5tOP]. (regardless of parameter mask)

Setting	Description
rUn	Forced control output run in STOP mode.
5tOP	Forced control output stop in RUN mode.

Setting group	Parameter	Setting range	Factory default	Unit
PAR1	r-5	rUn / 5tOP	rUn	-



Note

With stop enabled, the front panel's SV display indicates 5tOP.

You can change the setting when in the stop state. The stop status will remain in effect after shutting down the controller and powering it back on.

When stop is in effect, STOP MV[5t.nu] will be output. In case of a sensor break occurring while in STOP, STOP MV[5t.nu] is output.

The run/stop setting remains in effect after turning power back on.

If the digital Input (DI-1, DI-2) feature has been set for RUN/STOP[5tOP], RUN/STOP feature by modifying front keys or parameter is unable.

6.7.2.1 Stop control output settings [PAR5 → 5t.nu]

This parameter sets the control output value when in the stop state. With ON/OFF control, select between 100.0 (ON) and 000.0 (OFF). With PID control, the user can adjust the MV between 000.0 and 100.0.

Setting group	Parameter	Setting range		Factory default	Unit	
PAR5	5t.nu	Standard Control	ON/OFF Control	000.0 (OFF) / 100.0 (ON)	000.0	%
			PID Control	000.0 to 100.0	000.0	
		Heating & cooling Control	ON/OFF Control	+100.0 (Cooling ON) / 000.0 (OFF) / 100.0 (Heating ON)	000.0	
			PID Control	+100.0 (Cooling) to 100.0 (Heating)	000.0	



Note

Ignores MV from ON/OFF control or PID control and sends out a control value based on the defined MV.

6.7.2.2 Stop alarm output [PAR5 → StAL]

Enable or disable alarm output upon a stop.

Setting	Description
oFF	Alarm output ceases along with a stop under all conditions. (However, reverting to RUN mode after a stop in alarm latch or alarm latch and standby sequence restores the alarm output to the previous state.)
Cont	Alarm output continues regardless of control operation.

Setting group	Parameter	Setting range	Factory default	Unit
PAR1	r-5	Cont / oFF	Cont	-

6.7.3 Multi SV

Multi SV function allows users to set multiple SVs and save each setting in S_U0 to S_U3. Users can change S_U-n or select desired SV using external digital input terminal (digital input, DI-1, DI-2) function.

This feature supports up to four SVs which can be independently configurable.

6.7.3.1 Number of Multi SVs [PAR5 → nSt.SV]

This parameter sets the number of Multi SVs. Select the number of Multi SVs required by the control subject.

Number of SVs	SV Assignment
1 EA	S _U -0
2 EA	S _U -0, S _U -1
4 EA	S _U -0, S _U -1, S _U -2, S _U -3

Setting group	Parameter	Setting range	Factory default	Unit
PAR5	nSt.SV	1 / 2 / 4	1	Number of SVs



Note

If the digital Input (DI-1, DI-2) feature has been set for multi SV [nSt.SV], the number of Multi SV is not modified through pressing key or communication.(regardless of parameter mask)

6.7.3.2 Multi SV No. selection [PAR1 → S_U-n]

Select the SV to control.

Setting group	Parameter	Setting range	Factory default	Unit
PAR1	S _U -n	S _U -0 / S _U -1 / S _U -2 / S _U -3	S _U -0	-



Note

The range of figures assigned to each SV (SV No.) varies depending on the number of Multi SVs [nSt.SV] setting.

6.7.3.3 Multi SV settings [PAR 1 → SV-0/SV-1/SV-2/SV-3]

Designate the value of each SV for Multi SVs.

Setting group	Parameter	Setting range	Factory default	Unit
PAR 1	SV-0	Setting value low-limit [L-SV] to Setting value high-limit [H-SV]	0	°C,°F,-
	SV-1			
	SV-2			
	SV-3			

6.7.4 Digital input

6.7.4.1 Digital input terminal settings [PAR 5 → DI-1/DI-2]

By connecting an external input to a digital input terminal, you can perform preset digital input terminal functions.

Setting	Description
OFF	Not used
STOP	Run/Stop
ALRE	Alarm output deactivation
MAN	Auto/manual control selection
MSV	Multi SV selection

In the case one of DI-1 or DI-2 being set for Multi SV[MSV], SV-0 is selected as the SV if the terminal's external contact signal is off and SV-1 is selected if the signal is on.

If both DI-1 and DI-2 are configured for Multi SV[MSV], you can select the SV using combinational logic of the terminals. If multi SV [MSV] are changed from 4 to 2, DI-2 will be turned OFF automatically, changed from 4 to 1, both DI-1 and DI-2 will be turned OFF or changed from 2 to 1, concerned DI will be OFF.

DI-1	DI-2	Multi SV No.
OFF	OFF	SV-0
ON	OFF	SV-1
OFF	ON	SV-2
ON	ON	SV-3

Setting group	Parameter	Setting range	Factory default	Unit
PAR 5	DI-1	OFF / STOP / ALRE / MAN / MSV	OFF	-
	DI-2			



Note

When powered on, the digital input feature checks always the settings of terminal input.



Multi SV parameter will be activated only if Multi SV is more than 2.

The TK4SP Series has a limited number of terminal blocks and does not feature a digital input terminal. Therefore, the digital input terminal functions are not available.

The TK4S, M Series has a limited number of terminal blocks. Therefore, the digital input terminal1 (DI-1) is available. (In case of TK4S-D4 □□, only DI-1, DI-2 are available)

Digital input terminal function operates irrespective of 6.7.7 Lock , 6.7.9 Password settings [PAR5 → Pwd], 8.3.1 Parameter mask.

6.7.4.2 Digital input key

With digital input key enabled in RUN mode, press and hold   keys at the same time for 3 sec. to activate the preset function.

6.7.4.2.1. Digital input key settings [PAR5 → di - ④]

In order to use the digital input key feature, each function has to be first assigned to the keys.

Setting	Description
StoP	RUN/STOP
ALrE	Forced alarm output deactivation
Aut	Auto-tuning RUN/OFF (in case of control method is PID control)
oFF	Not used

Setting group	Parameter	Setting range	Factory default	Unit
PAR5	di - ④	StoP / ALrE	StoP	-



Note

If the digital input key and the digital input terminal set equally, the digital input key does not act.

6.7.4.2.2. Digital input key use

Press the digital input keys on the front panel to execute the function assigned to the keys.

When in RUN mode, press and hold  +  keys for 3 sec. to execute the assigned function (run/stop or alarm output deactivation).



Note

If the same function is assigned to a digital input key and the digital input terminal, activation takes place as an "or" function and deactivation as an "and" function. (However, this does not apply to the Multi SV feature [nt.5v] of digital input terminals.)

Digital input key functions operate irrespective of 6.7.9 Password settings [PAR5 → Pwd], 8.3.1 Parameter mask.

6.7.5 Error

The controller diagnoses input signals for errors and displays messages accordingly. These messages inform the user of device problems.

Message	Input	Description	Output
HHHH	Temperature sensor	Flashes at 0.5 sec. intervals if the input value is above the input range.	Standard type: Heating: 0%, Cooling: 100% Heating&Cooling: Heating: 0%, Cooling: 100%
	Analog	Flashes at 0.5 sec. intervals if the input value is over 5 to 10% of high limit or low limit value.	Normal output
LLLL	Temperature sensor	Flashes at 0.5 sec. intervals if the input value is below the input range.	Standard type: Heating: 100%, Cooling: 0% Heating&Cooling: Heating: 100%, Cooling: 0%
	Analog	Flashes at 0.5 sec. intervals if the input value is over 5 to 10% of low limit or high limit value.	Normal output
oPE _n	Temperature sensor	Flashes at 0.5 sec. intervals in the event of an input disconnection.	Outputs the set MV at $E_{r.\bar{n}u}$
	Analog	Flashes at 0.5 sec. intervals if F.S. is over $\pm 10\%$.	
E _{rr}	Temperature sensor	Flashes at 0.5 sec. intervals if there is error for setting and it returns to the error-before screen.	-

When input value returns to the input range, alarm is deactivated and it operates normally.



Note

When in heating control mode and powered on, or standard control state, output is 0% if HHHH is displayed and 100% if LLLL is displayed.

When in cooling control and powered on (or standard control state), output is 100% if HHHH is displayed and 0% if LLLL is displayed.

When in heating & cooling control and powered on or standard control state, heating output is 0% and cooling output 100% if HHHH is displayed, and heating output is 100% and cooling output 0% if LLLL is displayed.

6.7.5.1 MV Settings upon sensor break error [oPE_n](MV for Error) [PAR5 → E_{r._nu}]

In the event of a sensor open error you can set control output value to predefined MV instead of ON/OFF control or PID control.

Ignores MV by ON/OFF control or PID control, and sends out a control value based on the defined MV.

Setting group	Parameter	Setting range		Factory default	Unit	
PAR5	E _{r._nu}	Standard Control	ON/OFF Control	0000 (OFF)/1000 (ON)	0000	%
			PID Control	0000 to 1000		
		Heating & cooling Control	ON/OFF Control	-1000 (Cooling On) /10000 (OFF)/1000 (Heating On)		
			PID Control	-1000 (Cooling) to 1000 (Heating)		

6.7.6 User level setting [PAR5 → USER]

You can restrict parameter display by setting user level (standard or high).

When you set as a standard level user, the main function parameters shaded on the entire parameter list (See the 5.3 Parameter group), are only displayed.

Parameter	Parameter description
Stnd	Activates standard user parameters
HIGH	Activates all parameters

Setting group	Parameter	Setting range	Factory default	Unit
PAR5	USER	Stnd / HIGH	Stnd	-

6.7.7 Lock settings

6.7.7.1 SV group lock [PAR5 → LCSU]

You can restrict SV parameter modification by locking SV group parameters, which include SV selection, digital input key (keys for 3 sec.), (A/M) (the MODE key for TK4N, TK4S, TK4SP model) key for monitoring and manual control, parameter reset [INIT], etc.

Setting	Function
on	Activates SV group lock.
off	Deactivates SV group lock.

Setting group	Parameter	Setting range	Factory default	Unit
PAR5	LCSU	on / off	off	-

6.7.7.2 Parameter group lock [PAR5 → LCP1/LCP2/LCP3/LCP4/LCP5]

Lock or unlock individual parameter groups from parameter 1 group [PAR1] to parameter 5 group [PAR5].

Even with parameter group lock in place, you can still read parameter settings.

In Parameter 5's [PAR5] case, the settings can still be modified even with a lock [LCSU/LCP□] initiated.



Parameter	Parameter description
on	Lock parameter group
off	Unlock parameter group

Parameter	Parameter description
LCP1	Lock parameter 1 group.
LCP2	Lock parameter 2 group
LCP3	Lock parameter 3 group
LCP4	Lock parameter 4 group
LCP5	Lock parameter 5 group

Setting group	Parameter	Setting range	Factory default	Unit
PAR5	LCP1 to LCP5	on / off	off	-

6.7.8 Parameter reset [i n i t]

This function is to reset all parameters in memory to factory defaults.

Press and hold the front panel's    keys for 5 sec. The *i n i t* parameter will be displayed. Select *Y E 5* to reset the parameters.

Setting group	Parameter	Setting range	Factory default	Unit
-	<i>i n i t</i>	<i>Y E 5 / n o</i>	<i>n o</i>	-



Note

If the password feature is activated, it is required to enter a password to activate this function. Resetting the parameters also resets the password.

If this parameter reset [*i n i t*] is masked, it cannot be used.

6.7.9 Password settings [*P A r 5* → *P w d*]











Assigning password access to SV group features (excluding digital input key) and Parameter 1 through 5 prevents unauthorized modification to the parameter settings.

Password setting applies to SV group features (excluding digital input key) and Parameter 1 through 5 comprehensively.

Changing the password setting automatically activates password protection. Setting the password to *0000*, however, disables password protection.

0001 is a read-only password. Under this setting, the user may check parameter settings without knowing the password. The user, however, cannot change parameter settings.

Accessing the *P w d* parameter with the read-only password displays a coded form of the setting.

- Settings
 - 1st When in RUN mode, press and hold the  key.
 - 2nd Use the   keys to select *P A r 5* and then press the  key.
 - 3rd Press the  key to search *P w d*.
 - 4th Select the desired digit using the  key.
 - 5th Use the   keys to set the password (*0000*, *0002* to *9999*) then press the  key to set the password.
 - 6th Repeat steps 4 and 5 and enter the preset password.
 - 7th Press the  key or do not make any additional key entry for 3 sec. to save the password.

Setting group	Parameter	Setting range	Factory default	Unit
<i>P A r 5</i>	<i>P w d</i>	<i>0000</i> (password protection deactivated.) <i>0002</i> to <i>9999</i> (password protection on.)	<i>0000</i>	-







Note

'6.7.4 Digital input' features are not affected by password protection settings.

6.7.9.1 Password entry [P_{ASS}]

If password protection is turned on, accessing SV parameters or groups when the unit is in RUN mode will prompt a password confirmation parameter [P_{ASS}]. Then, the correct password has to be entered to access the setting parameters.

- Settings
 - 1st Access SV parameter or parameter group.
 - 2nd When prompted with P_{ASS}, use the  key to select the desired digit.
 - 3rd Use the   keys to enter the password (0001 through 9999) and then press the  key.
- If the correct password is entered, you can access setting parameters.
- If an incorrect password is entered, repeat steps 2 and 3 and enter the correct password.

Setting group	Parameter	Setting range	Factory default	Unit
P _{AS}	P _{ASS}	0001 (read-only), 0002 to 9999	0001	-



Note

If the password is unknown, enter 0001 to access the parameters in read-only mode.





This parameter only appears if the setting from 6.7.9 Password settings [P_{AS} → P_{UD}] is set to a value other than 0000.

If an incorrect password has been entered, the SV display section displays a coded form of the password stored by the user and an error message [E_{rr}]. Then, the error message flashes in 1 sec. intervals.

6.7.9.2 Password recovery

Entering an incorrect password displays a coded form of the password on the SV display. Submit this code to Autonics to recover your lost password.

Incorrect Password Entry (For example, the correct password being 1234)



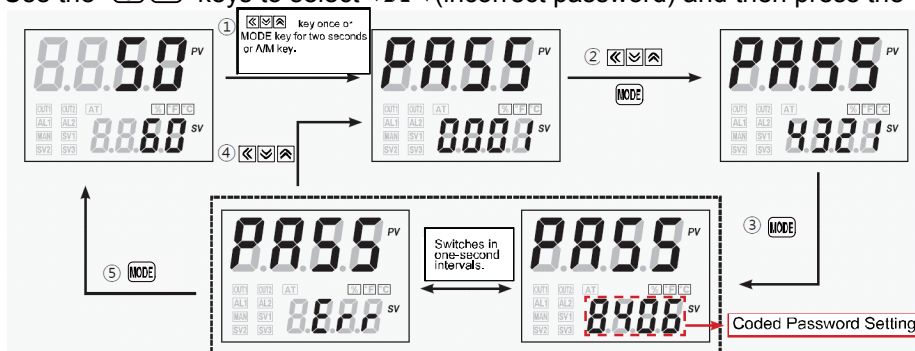



- 1st Access SV parameter or parameter group.
 - 2nd When prompted with P_{ASS}, use the  key to select the desired digit.
- Use the   keys to select 4321 (incorrect password) and then press the  key.



Entering an incorrect password displays a coded password on the SV display. An E_{rr} message will also appear, flashing at 1 sec. intervals.

7 Setting group parameter description

7.1 Setting group [5_U]

Parameter		Description	Set range	Unit	Factory default
5 _U	Set value	SV	Between L - 5 _U and H - 5 _U	°C/°F/-	0
  key	Digital input Key Execute	Digital input execution key	Press the   keys more than 3 sec.	-	-
 key	Auto_Manual Monitoring/Control	MV monitoring/manual control execution key	Press the  key more than 1 sec.	-	-
init	Parameter initialize	Resets parameters to factory defaults	no / YES	-	no

7.2 MV monitoring/manual control setting group [\bar{n}_U]

Parameter		Description	Set range	Unit	Factory default
H - \bar{n}_U	Heating_MV	Heating MV	H 0.0 to H 100	%	-
L - \bar{n}_U	Cooling_MV	Cooling MV	L 0.0 to L 100	%	-

※ It is possible to manually control and monitor heating & cooling MVs at the same time.

7.3 Parameter 1 setting group [PAr 1]

Parameter		Description	Set range	Unit	Factory default
r-5	RUN_STOP	Control Output RUN/STOP	rUn / StOP	-	rUn
5u-n	Multi SV No.	Multi SV number selection	5u-0 / 5u-1 / 5u-2 / 5u-3	-	5u-0
Et-A	Heater current monitoring	Heater current monitoring	0.0 to 50.0 (display range)	A	-
AL 1L	Alarm1_low	Alarm output 1's low-limit value	Offset Alarm: -F.S. to F.S. Absolute Value Alarm: Within display range.	°C/°F/-	1550
AL 1H	Alarm1_high	Alarm output 1's high-limit value			
AL 2L	Alarm2_low	Alarm output 2's low-limit value			
AL 2H	Alarm2_high	Alarm output 2's high-limit value.			
AL 3L	Alarm3_low	Alarm output 3's low-limit value			
AL 3H	Alarm3_high	Alarm output 3's high-limit value.			
5u-0	SV-0 set value	SV-0 set value	Between L-5u and H-5u	°C/°F/-	0000
5u-1	SV-1 set value	SV-1 set value	Between L-5u and H-5u	°C/°F/-	0000
5u-2	SV-2 set value	SV-2 set value	Between L-5u and H-5u	°C/°F/-	0000
5u-3	SV-3 set value	SV-3 set value	Between L-5u and H-5u	°C/°F/-	0000

7.4 Parameter 2 setting group [PAr2]

Parameter	Description	Description	Set range	Unit	Factory default
<i>Rt</i>	Auto-tuning execute	Auto-tuning ON/OFF	<i>oFF/on</i>	-	<i>oFF</i>
<i>H-P</i>	Heating_proportional band	Heating proportional band	<i>000.1 to 999.9</i>	°C/°F/%	<i>0 100</i>
<i>C-P</i>	Cooling_proportional band	Proportional band in cooling mode			
<i>H-I</i>	Heating_integral time	Heating integral time	<i>0000 to 9999</i>	Sec	<i>0000</i>
<i>C-I</i>	Cooling_integral time	Cooling integral time			
<i>H-d</i>	Heating_derivation time	Heating derivative time	<i>0000 to 9999</i>	Sec	<i>0000</i>
<i>C-d</i>	Cooling_derivation time	Cooling derivative time			
<i>db</i>	Dead_overlap band	Heating & cooling control dead band	P/P, P/ONOFF, and ONOFF/P Controls -Proportional Band to 0.0 to +Proportional Band (if different, based on whichever is lesser) ONOFF/ONOFF Control -999 to 9999 (Temperature H) +99.9 to 999.9 (Temperature L)	Digit	<i>0000</i>
			-99.9 to 999.9 (Analog)	%F.S.	<i>0000</i>
<i>rESt</i>	Manual reset	Manual reset under proportional control	<i>000.0 to 100.0</i>	%	<i>050.0</i>
<i>H.HYS</i>	Heating_ON hysteresis	Heating hysteresis	<i>00 1 to 100 (000.1 to 100.0)</i>	Digit	<i>002 (002.0)</i>
<i>H.oSt</i>	Heating_OFF offset	Heating off point offset	<i>000 to 100 (000.0 to 100.0)</i>	Digit	<i>000</i>
<i>C.HYS</i>	Cooling_ON hysteresis	Cooling hysteresis	<i>00 1 to 100 (000.1 to 100.0)</i>	Digit	<i>002 (002.0)</i>
<i>C.oSt</i>	Cooling_OFF offset	Cooling off point offset	<i>000 to 100 (000.0 to 100.0)</i>	Digit	<i>000</i>
<i>L-ñu</i>	MV low-limit	MV low-limit setting	<i>000.0 to H-ñu-0.1 (standard control) +100.0 to 000.0 (heating & cooling control)</i>	%	<i>000.0 (+100.0)</i>
<i>H-ñu</i>	MV high-limit	MV high-limit value	<i>L-ñu+0.1 to 100.0 (standard control) 000.0 to 100.0</i>	%	<i>100.0 (100.0)</i>

Parameter		Description	Set range	Unit	Factory default
			(heating & cooling control)		
<i>r.Ān̄u</i>	Ramp_up rate	Ramp rise rate	000 to 999 (000.0 to 999.9)	°C/°F/ Digit	000
<i>r.Ān̄d</i>	Ramp_down rate	Ramp down rate	000 to 999 (000.0 to 999.9)	°C/°F Digit	000
<i>r.Ūn̄t</i>	Ramp time unit	Ramp time unit	SEC / m̄i n / Hour	-	m̄i n

7.5 Parameter 3 setting group [PAR3]

Parameter	Description	Description	Set range	Unit	Factory default	
<i>Input</i>	Input type	Input type	See Input types chart.	-	TEMP	
<i>Unit</i>	Unit	Sensor temperature unit	°C / °F	-	°C	
<i>L-rG</i>	Low input range	Analog low-limit input value	Minimum range. to <i>H-rG</i> - F.S.10%	Digit	0000	
<i>H-rG</i>	High input range	Analog high-limit input value	<i>L-rG</i> +F.S.10% to Maximum range.	Digit	1000	
<i>dot</i>	Scaling decimal point	Decimal point position - scale value	0 / 0.0 / 0.00 / 0.000	-	0.0	
<i>L-SC</i>	Low scaling	Scale low-limit display value	-9999 to 9999	-	0000	
<i>H-SC</i>	High scaling	Scale high-limit display value	-9999 to 9999	-	1000	
<i>dUnit</i>	Display unit indicator	Front unit display	°C / °F / °Pd / OFF	-	°Pd	
<i>in-b</i>	Input correction	Input correction	-999 to 9999 (-9999 to 9999)	Digit	0000	
<i>RAF</i>	Input digital filter	Moving average digital filter	000.1 to 1200	Sec	000.1	
<i>L-Sv</i>	SV low-limit	SV low-limit value	Input Low-limit [<i>L-SC</i>] to <i>H-Sv</i> -1digit	°C/°F/%	-200	
<i>H-Sv</i>	SV high-limit	SV high-limit value	<i>L-Sv</i> +1digit to input high-limit [<i>H-SC</i>]	°C/°F/%	1350	
<i>o-Flt</i>	Control operating type	Control output operation mode	Standard	HEAT / COOL	-	HEAT
			Heating & Cooling type	HEAT / COOL / H-C		H-C
<i>C-Mod</i>	Control method	Temperature control type	Standard	PI d / ONOFF	-	PI d
			Heating & Cooling type	PP / P.on / ON.P / ON.ON		PP
<i>Aut</i>	Auto-tuning type	Auto-tuning mode	Auto1 / Auto2	-	Auto1	
<i>out1</i>	Output1 (SSR_Curr) type	OUT1 control output type	SSR / CURR	-	CURR	
<i>o1Sr</i>	OUT1 SSR function	OUT1 SSR drive output type	Stand / CYCL / PHAS	-	Stand	
<i>o1nR</i>	OUT1 current range	OUT1 current output range	4-20 / 0-20	-	4-20	
<i>out2</i>	Output2 (SSR_Curr) type	OUT2 control output type	SSR / CURR	-	CURR	
<i>o2nR</i>	OUT2 current range	OUT2 current output range	4-20 / 0-20	-	4-20	

Parameter		Description	Set range	Unit	Factory default
H-t	Heating_control time	Heating control period	Relay output, SSR drive output(standard ON/OFF, phase, cycle control): 000.1 to 1200 Current output, SSR drive output: 000.1 to 1200	Sec	0200 (Relay) 0200 (SSR)
C-t	Cooling_control time	Cooling control period		Sec	

7.6 Parameter 4 setting group [PAR4]

Parameter	Description	Set range	Unit	Factory default
AL-1	Alarm1 mode	Alarm output 1 operation mode oFF / du[[/]]du /]du[[du] / Pu[[/]]Pu / LbA SbA / HbA	-	du[[
AL-1t	Alarm1 type	Alarm output 1 option/type AL-A / AL-b / AL-c / AL-d / AL-E / AL-F	-	AL-A
ALHY	Alarm1 hysteresis	Alarm output 1 hysteresis 001 to 100 (000.1 to 1000)	Digit	001
ALn	Alarm1 N.O./N.C.	Alarm output 1 N.O./N.C. no / n[-	no
ALon	Alarm1 ON delay time	Alarm output 1 ON delay 0000 to 3600	Sec	0000
ALoF	Alarm1 OFF delay time	Alarm output 1 OFF delay 0000 to 3600	Sec	0000
AL-2	Alarm2 mode	Alarm output 2 operation mode oFF / du[[/]]du /]du[[du] / Pu[[/]]Pu / LbA SbA / HbA	-]]du
AL-2t	Alarm2 type	Alarm output 2 option/type AL-A / AL-b / AL-c / AL-d / AL-E / AL-F	-	AL-A
AL2HY	Alarm2 hysteresis	Alarm output 2 hysteresis 001 to 100 (000.1 to 1000)	Digit	001
AL2n	Alarm2 N.O./N.C.	Alarm output2 N.O./N.C. no / n[-	no
AL2on	Alarm2 ON delay time	Alarm output 2 ON delay 0000 to 3600	Sec	0000
AL2oF	Alarm2 OFF delay time	Alarm output 2 OFF delay 0000 to 3600	Sec	0000
AL-3	Alarm3 mode	Alarm output 3 operation mode oFF / du[[/]]du /]du[[du] / Pu[[/]]Pu / LbA / SbA / HbA	—	oFF
AL-3t	Alarm3 type	Alarm output 3 option/type AL-A / AL-b / AL-c / AL-d / AL-E / AL-F	—	AL-A
AL3HY	Alarm3 hysteresis	Alarm output 3 hysteresis 001 to 100 (000.1 to 1000)	Digit	001
AL3n	Alarm3 N.O./N.C.	Alarm output 3 N.O./N.C. no / n[—	no
AL3on	Alarm3 ON delay time	Alarm output 3 ON delay 0000 to 3600	Sec	0000
AL3oF	Alarm3 OFF delay time	Alarm output 3 OFF delay 0000 to 3600	Sec	0000
LbAt	LBA time	LBA monitoring time 0000 to 9999	Sec	0000

Parameter		Description	Set range	Unit	Factory default
LbAb	LBA band	LBA detection band.	0000 to 999 (temperature H)	°C/°F/%	002
			0000 to 999.9 (temperature L)		002.0
			0000 to 999.9 (analog)	%	000.2
RoAn1	Analog output mode	Analog transmission 1 output value	Pu / Su / H-nu / [-nu]	-	Pu
FSL1	Low out scale	Transmission output 1 low-limit value	F.5	-	-200
F5H1	High out scale	Transmission output 2 high-limit value	F.5	-	1350
RoAn2	Analog output mode	Analog transmission 2 output	Pu / Su / H-nu / [-nu]	-	Pu
FSL2	Low out scale	Transmission output 2 low-limit value	F.5	-	-200
F5H2	High out scale	Transmission output 2 high-limit value	F.5	-	1350
Adr5	Unit address	Unit address.	01 to 99	-	01
bPS	Bits per second	BPS (bits per second)	24 / 48 / 96 / 192 / 384	-	96
Prty	Parity bit	Communication parity bit	none / Even / odd	-	none
StP	Stop bit	Stop bit	1 / 2	-	2
rStt	Response waiting time	Response waiting time	5 to 99	ms	20
ConW	Communication write	Communication write permission	EnA / disA	-	EnA

7.7 Parameter 5 setting group [PAr5]

Parameter	Description	Set range	Unit	Factory default
$\bar{n}t.Sv$	Multi SV	Number of multi SVs	1 / 2 / 4	Number of SVs 1
$di - \bar{t}$	Digital Input Key Function	DI input key function on the front panel	StoP / ALrE / Rt / oFF	- StoP
$di - 1$	Digital Input 1 Function	DI-1 digital Input function	oFF / StoP / ALrE	- oFF
$di - 2$	Digital Input 2 Function	DI-2 digital Input function	/ $\bar{n}An$ / $\bar{n}t.Sv$	- oFF
$it.\bar{n}v$	Initial manual MV	Manual control baseline MV	RUto / Pr. $\bar{n}v$	- RUto
$Pr.\bar{n}v$	Preset manual MV	Manual control initial MV	000.0 to 100.0 (standard control) +100.0 to 100.0 (heating & cooling control)	% 000.0
$Er.\bar{n}v$	Error MV	Sensor error MV	000.0 to 100.0 (standard control) +100.0 to 100.0 (heating & cooling control)	% 000.0
$St.\bar{n}v$	Stop MV	Control stop MV	000.0 to 100.0 (standard control) +100.0 to 100.0 (heating & cooling control)	% 000.0
$St.AL$	Stop alarm out	Control stop alarm output	Cont / oFF	- Cont
$USEr$	User level	User level	Stnd / HIGH	- Stnd.
$LC.Sv$	Lock SV	SV parameter lock	on / oFF	- oFF
$LC.P1$	Lock parameter 1	Parameter 1 group lock	on / oFF	- oFF
$LC.P2$	Lock parameter 2	Parameter 2 group lock	on / oFF	- oFF
$LC.P3$	Lock parameter 3	Parameter 3 group lock	on / oFF	- oFF
$LC.P4$	Lock parameter 4	Parameter 4 group lock	on / oFF	- oFF
$LC.P5$	Lock parameter 5	Parameter 5 group lock	on / oFF	- oFF
Pyd	Password setting	Password setting	0000: Password protection off. 0002 to 9999	- 0000

7.8 Password entry parameter

Parameter		Description	Set range	Unit	Factory default
<i>PR55</i>	Password	Password entry.	0001 to 9999 (0001: read-only)	-	0001

7.9 Parameter change reset parameters

Changed parameter	Description	Reset parameter
<i>input</i>	Input types	<i>Su-n, AL1L, AL1H, AL2L, AL2H, AL3L, AL3H, Su0</i> to <i>Su3, db, HHYS, HOSL, CHYS, COSL, rANU, rAND, rUNL, L-rG, H-rG, dot, L-SL, H-SL, dUNL, i-n-b, L-Su, H-Su, LbAL, LbAb, Aoñ1, FSL1, FSH1, Aoñ2, FSL2, FSH2</i>
<i>Unit</i>	Temperature input unit	With the exception of <i>L-rG, H-rG, dot, L-SL, H-SL</i> , and <i>dUNL</i> , Input type does not affect input units.
<i>H-Su</i>	SV high-limit value	When $SV > H-Su$, SV resets to <i>H-Su</i> .
<i>L-Su</i>	SV low-limit value	When $SV < L-Su$, SV resets to <i>L-Su</i> .
<i>o-Fl</i>	Control output operation mode	<i>L-nu, H-nu, C-nd, Er-nu, Pr-nu, St-nu</i>
<i>C-nd</i>	Temperature control type	<i>L-nu, H-nu, Er-nu, Pr-nu, St-nu</i>
<i>AL-1, AL-2, AL-3</i>	Alarm mode/option	<i>AL1L, AL1H, AL2L, AL2H, AL3L, AL3H</i>

8 DAQMaster

8.1 Overview

DAQMaster is a comprehensive device management program that can be used with Autonics communication supporting products.

DAQMaster provides GUI control for easy and convenient management of parameters and multiple device data monitoring.

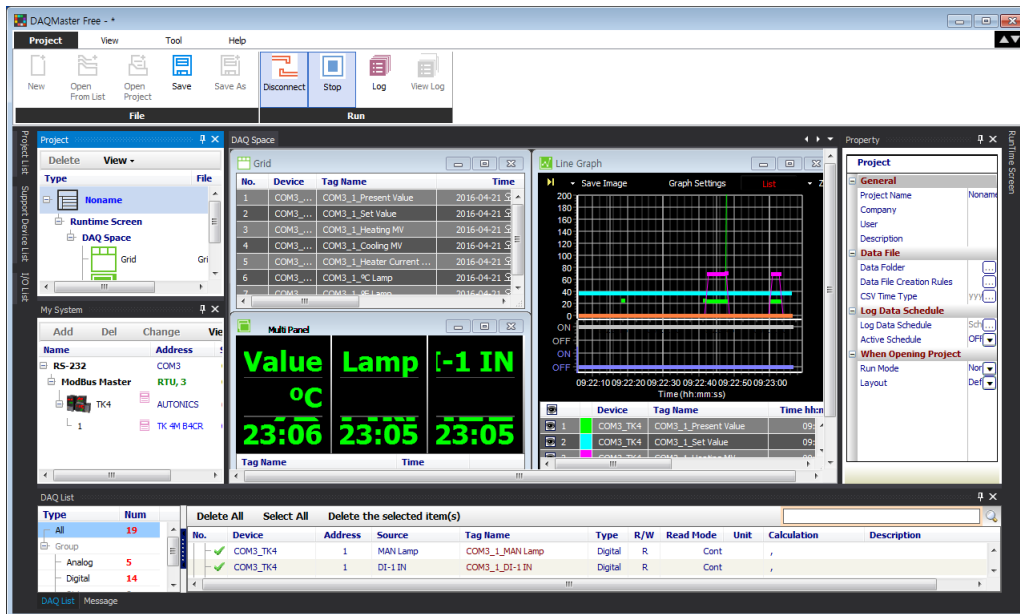

Note

For more information, visit our website (www.autonics.com) to download "DAQMaster user manual".

8.2 Major features

(1) DAQMaster Pro Version Feature

- Data Base
Database managing system (Access, MySQL, SQL Server, Oracle, SQLite) turns information into database in real-time, making creation and management of database easier.
- Real-time Logging
At the set cycle and condition, real-time log file is generated in CSV file.
- Modbus Device Editor
You can add the any modbus devices which are not supported at DAQMaster to set and monitor the property and I/O.
- OPC Client
It is Interface method for better compatibility among application programs based on OLE/COM and DCOM technology of Microsoft. It provides industry standard mechanism for communication and data conversion between client and server.
- DDE Client
It supports communication (IPC) among process embedded in Microsoft Window system, allowing application programs to share and exchange information. This function uses shared memory and provides a common protocol (instruction set and message format) to application programs.

(2) Features

- Multiple Device Support
Simultaneously monitor multiple devices and set parameters. Simultaneously connect units with different addresses in a single device. Multiple RS-232 ports are available for communications using Modbus remote terminal unit.
- Device Scan
In cases of multiple units (with different addresses) connected together, the unit scan function automatically searches for units.
- Convenient User Interface
Freely arrange windows for data monitoring, properties, and projects. Saving a project also saves the screen layout.
- Project Management
Saving data as a project file includes added device information, data monitoring screen layouts, and I/O source selection. When you open the project file, the last state of the saving moment will be loaded. Organizing project list makes managing project files easier.
- Data Analysis
Performs grid and graph analyses of data files (*.ddf) using data analysis feature of DAQMaster. Saves grid data in .rtf, .txt, .html, or .csv files in Data Grid.
- Monitoring Data Log
When monitoring, data log files can be saved in either DAQMaster data files (.ddf) or CSV (.csv) files. Open files saved in .csv format directly from Microsoft Excel. Define log data file naming/saving rules and destination folders to make file management convenient.
- Tag Calculation Editing
Read tag value is available to calculate the set formula for the desired value.

- **Print Modbus Map Table Report**
Print address map reports of registered Modbus devices. Modbus map table reports can be saved in html (*.html) and pdf (*.pdf) formats.
- **Multilingual Support**
Supports Korean, English, Japanese, and Simplified Chinese. To add a different language, modify the files in the Lang folder rename, and save.
- **Script Support**
Uses the Lua Script language and deals with different I/O processes for individual devices.

8.3 Special feature for TK Series

Parameter mask and user parameter group is available by DAQMaster. Visit our website (www.autonics.com) to download DAQMaster software and the manual.

8.3.1 Parameter mask

This feature is able to hide unnecessary parameters to user environment or less frequently used parameters in parameter group.

Masked parameters are not only displayed. The set value of masked parameters are applied.

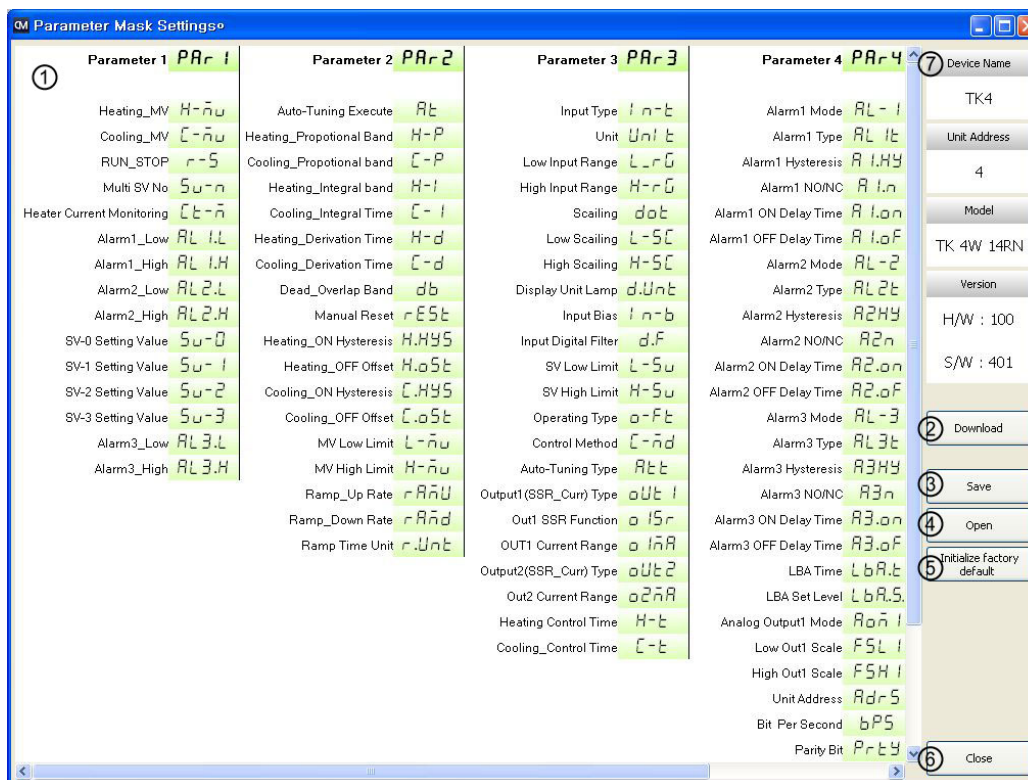

No	Item	Description
①	Parameter mask selection	Select the to-be masked parameters. Right-click the to-be masked parameters and they turn gray.
②	Download	Applies the set masked parameters to the device.
③	Save	Saves the set masked parameters as a mask information file.
④	Open	Opens the saved mask information file.
⑤	Initialize factory default	Clears the set for the masked parameters. Download this setting to apply it to the device.
⑥	Close	Closes the Parameter Mask Settings dialog.
⑦	Device information	Displays device name, unit address, model name, and version.

 Ex.



The screenshot shows the 'Parameter Mask Settings' window with four columns of parameters. The parameters are organized into groups, with some parameters masked (indicated by a grey background). The parameters are as follows:

Parameter 1 (PAR 1)	Parameter 2 (PAR 2)	Parameter 3 (PAR 3)	Parameter 4 (PAR 4)
Heating_MV H-nu	Auto-Tuning Execute At	Input Type In-t	Alarm1 Mode AL-1
Cooling_MV C-nu	Heating_Proportional Band H-P	Unit Unit	Alarm1 Type AL-1t
RUN_STOP r-S	Cooling_Proportional band C-P	Low Input Range L-r0	Alarm1 Hysteresis A.1.HY
Multi SV No Su-n	Heating_Integral band H-I	High Input Range H-r0	Alarm1 NOINC A.1.n
Heater Current Monitoring Ct-n	Cooling_Integral Time C-I	Scalling dot	Alarm1 ON Delay Time A.1.on
Alarm1_Low AL.1.L	Heating_Derivation Time H-d	Low Scalling L-S0	Alarm1 OFF Delay Time A.1.oF
Alarm1_High AL.1.H	Cooling_Derivation Time C-d	High Scalling H-S0	Alarm2 Mode AL-2
Alarm2_Low AL.2.L	Dead_Overlap Band db	Display Unit Lamp d.Un	Alarm2 Type AL.2t
Alarm2_High AL.2.H	Manual Reset r.ESt	Input Bias In-b	Alarm2 Hysteresis A.2.HY
SV-0 Setting Value Su-0	Heating_ON Hysteresis H.HYS	Input Digital Filter d.F	Alarm2 NOINC A.2.n
SV-1 Setting Value Su-1	Heating_OFF Offset H.oSt	SV Low Limit L-Su	Alarm2 ON Delay Time A.2.on
SV-2 Setting Value Su-2	Cooling_ON Hysteresis C.HYS	SV High Limit H-Su	Alarm2 OFF Delay Time A.2.oF
SV-3 Setting Value Su-3	Cooling_OFF Offset C.oSt	Operating Type o-Ft	Alarm3 Mode AL-3
Alarm3_Low AL.3.L	MV Low Limit L-nu	Control Method C-n.d	Alarm3 Type AL.3t
Alarm3_High AL.3.H	MV High Limit H-nu	Auto-Tuning Type At	Alarm3 Hysteresis A.3.HY
	Ramp_Up Rate r.A.nU	Output1(SSR_Curr) Type oUt 1	Alarm3 NOINC A.3.n
	Ramp_Down Rate r.A.nD	Out1 SSR Function o.1Sr	Alarm3 ON Delay Time A.3.on
	Ramp Time Unit r.Un	Out1 Current Range o.1nA	Alarm3 OFF Delay Time A.3.oF
		Output2(SSR_Curr) Type oUt 2	LBA Time L.b.A.t
		Out2 Current Range o.2nA	LBA Set Level L.b.A.S
		Heating Control Time H-t	Analog Output1 Mode A.o.n.1
		Cooling_Control Time C-t	Low Out1 Scale F.S.L.1
			High Out1 Scale F.S.H.1
			Unit Address Ad-5
			Bit Per Second b.P.S
			Parity Bit P.r.t.Y

Example of masking alarm, SV setting parameters of parameter 1 group, input type, unit of parameter 3 group, and all of parameter 4 group.

8.3.2 User parameter group [PAR-U]

This feature is able to set the frequently used parameters to the user parameter group. You can quickly and easily set parameter settings.

User parameter group can have up to 30 parameters.

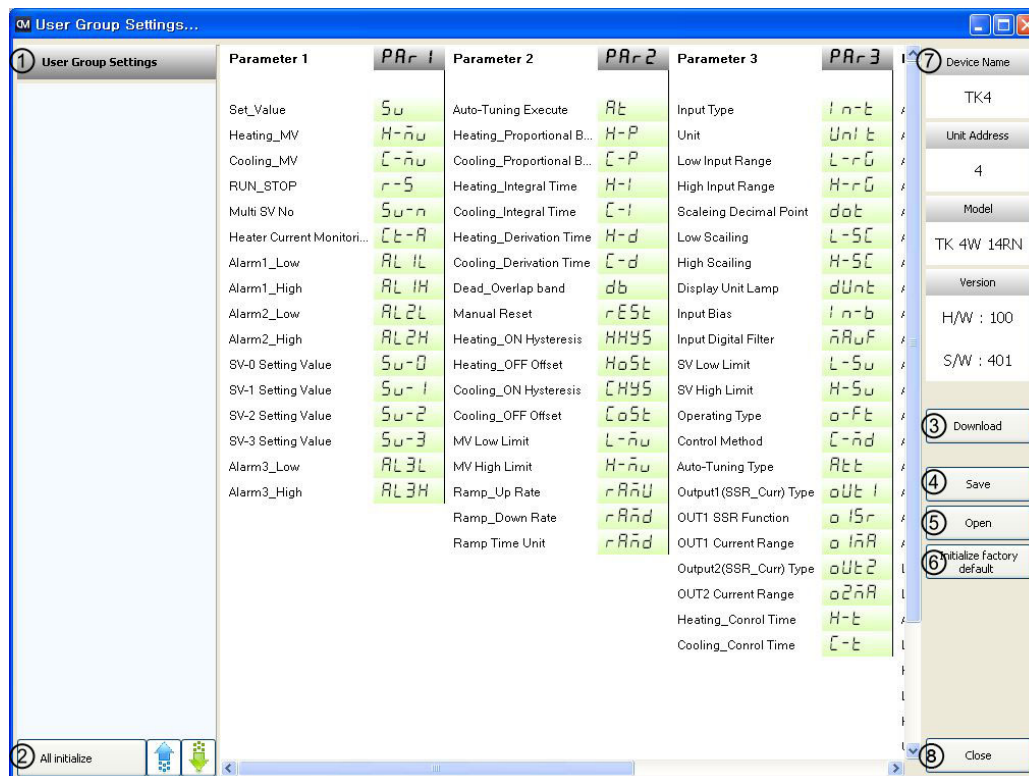

No	Item	Description
①	User parameter group	Displays the selected parameters as user parameter group. Double-click the parameters for the user parameter group, and these parameters turn gray. To delete the parameters at the user parameter group, double-click the parameters.
②	User parameter group selection	- All initialize: Initializes the set user parameter group. - ↑, ↓ : Changes the selected parameter order up/down.
③	Download	Applies the set user parameter group to the device.
④	Save	Saves the set user group as user parameter group information file.
⑤	Open	Opens the saved user parameter group file.
⑥	Initialize factory default	Clears the set for the user parameter group. Download this setting to apply it to the device.
⑦	Device information	Displays device name, unit address, model name, and version.
⑧	Close	Closes the User Parameter Group Settings dialog.



Ex.

Example of the set user parameter group with SV setting, control output RUN/STOP, alarm output 1 low/high-limit, SV-0/1/2/3 set value, manual reset, input correction, alarm output 1 mode/option/hysteresis/contact type/ON delay time/OFF delay time parameters.

Autonics

Sensors & Controllers

www.autonics.com

Distributor



■ Major Products

·Photoelectric Sensors-Fiber Optic Sensors-Door Sensors-Door Side Sensors-Area Sensors
·Proximity Sensors-Pressure Sensors-Connectors/sockets-Rotary Encoders-Panel Meters
·Counters-Timers-Temperature Controllers-SSRs/Power Controllers-Sensor Controllers
·Graphic/Logic Panels-Temperature/Humidity Transducers-Switching Mode Power Supplies
·Stepper Motors/Drivers/Motion Controllers-I/O Terminal Blocks & Cables-Display Units
·Control Switches/Lamps/Buzzers-Field Network Devices-Tachometer/Pulse(Rate) Meters
·Laser Marking System(Fiber, CO₂, Nd:YAG)-Laser Welding/Cutting System

■ Any proposal for a product improvement and development: Product@autonics.com

■ Corporate Headquarters

18 Bansong-ro, 513 Beon-gil, Haecundae-gu, Busan, South Korea 48002
Tel: 82-51-519-3232

■ **Brazil – Autonics do Brasil Comercial Importadora Exportadora Ltda**
Tel: 55-11-2307-8480 / Fax: 55-11-2309-7784 / E-mail: comercial@autonics.com.br

■ **China – Autonics electronic(Jiaxing) Corporation**
Tel: 86-21-5422-5969 / Fax: 86-21-5422-5961 / E-mail: china@autonics.com

■ **India – Autonics Automation India Private Limited**
Tel: 91-22-2781-4305 / Fax: 91-22-2781-4518 / E-mail: india@autonics.com

■ **Indonesia – PT. Autonics Indonesia**
Tel: 62-21-8088-8814/5 / Fax: 62-21-8088-4442(4440) / E-mail: indonesia@autonics.com

■ **Japan – Autonics Japan Corporation**
Tel: 81-3-3950-3111 / Fax: 81-3-3950-3191 / E-mail: ja@autonics.com

■ **Malaysia – Mal-Autonics Sensor Sdn. Bhd.**
Tel: 60-3-7805-7190 / Fax: 60-3-7805-7193 / E-mail: malaysia@autonics.com

■ **Mexico – Autonics Mexico S.A. DE C.V**
Tel: 52-55-5207-0019 / Fax: 52-55-1663-0712 / E-mail: ventas@autonics.com

■ **Russia – Autonics Corp. Russia Representative Office**
Tel/Fax: 7-495-660-10-88 / E-mail: russia@autonics.com

■ **Turkey – Autonics Otomasyon Ticaret Ltd. Sti.**
Tel: 90-216-365-9117/3/4 / Fax: 90-216-365-9112 / E-mail: turkey@autonics.com

■ **USA – Autonics USA, Inc.**
Tel: 1-847-680-8160 / Fax: 1-847-680-8155 / E-mail: sales@autonicsusa.net

■ **Vietnam – Cong Ty TNHH Autonics Vina**
Tel: 84-8-3771-2662 / Fax: 84-8-3771-2663 / E-mail: vietnam@autonics.com